



Lights By Linea
— Since (1990) —

CATALOGUE

For the love of light

ABOUT US 8

PICTURE INDEX 12

TECHNICAL INFO 48

COMMERCIAL 52

HighBay & T-Bay 52

Utility Lights 58

LED Panels 64

Linear Lighting 74

Linear Retail Lighting 82

PENDANTS 87

Commercial / Retail 87

Architectural / Residential 93

CEILING 110

Ceiling Lights 110

Recessed Spots 120

Surface Spots 126

INDEX



DOWNLIGHTS – SURFACE **134**

Commercial & Architectural	134
Surface GU10	141

DOWNLIGHTS – RECESSED **145**

Commercial / Retail	145
Recessed Spots	167
Commercial & Architectural	172
Recessed GU10	190

TRACK & TRACK SPOTS **196**

1-Circuit Track	196
1-Circuit Spots	199
3-Circuit Tracks	205
3-Circuit Commercial Spots	211
3-Circuit Architectural Spots	223
3-Circuit Spots – GU10	228
Magnetic Tracks – Surface	231
Magnetic Tracks – Recessed	235
Magnetic Spots	239

LED STRIP LIGHTING **258**

Profiles & Diffusers	258
24V LED Strips	260
Accessories	284
Remote Controls	286

DRIVERS **289**

Dimmable Drivers	289
Non-Dimmable Drivers	295
Waterproof Drivers	298

WALL **301**

Art & Mirror Lighting	301
Illuminated Mirrors	312
Bedside Lighting	318
Decorative Wall Lights	327
Indoor Footlights	341

FLOOR **351**

Floor Lighting	351
Table Lighting	356
Recessed Uplights	362

OUTDOOR **366**

Post Tops	366
Bulkheads	369
Wall Lights	374
Wall Lights - GU10	381
Lanterns	386
Bollards	392
Footlights	399
Floodlights	409
Garden Spikes & Spots	416
Buried Uplights	423
Wall Washers	431
Special Effects	436

EMERGENCY **439**

Emergency Exit Signs	439
Emergency Lights	445
EMG Battery Packs	450

LAMPS **453**

OTHER **477**

Accessories	477
Sensors	481
Handsets	493

We are Lights By Linea

Lights By Linea (PTY) Ltd was founded in 1990, by now Chairman Wayne Roberts. A world-class lighting showroom and office space has grown out of what was once a modest shop in Bree Street, in the heart of Cape Town. Our facilities are now located in the bustling neighbourhood of Paarden Eiland.

We are a team of knowledgeable and ambitious professionals who have extensive experience in the lighting industry, and who pride themselves on the highest level of customer service.

Lights by Linea specialises in lighting design and specification for the retail, residential and commercial building sectors, and we have based our solid foundation in the industry on supplying the correct light fittings to suit design, budget and brief.

Driven by the desire to always be at the forefront of the most recent innovations in lighting technology, we are always researching, sourcing, and acquiring the best of what international and local manufacturers can offer the industry and market.

We can't wait to walk your lighting journey with you!





Thinking about design is hard,
but not thinking about it can be disastrous.

— RALPH CAPLAN





> COMMERCIAL

HIGHBAY & T-BAY

COMMERCIAL – HIGHBAY & T-BAY / UTILITY LIGHTS

COMMERCIAL



HIGHBAY GEN 3
pg 53



LHB03
pg 54



LLEDHB02
pg 55



LLED6SW6
pg 56



LLEDTP03
pg 57

> UTILITY LIGHTS

COMMERCIAL & ARCHITECTURAL



CAESAR
pg 59



EARL
pg 60



HARBOUR
pg 61



LLED6B11
pg 62



LLEDTP03
pg 63



Project: MediaCity - Steinenbosch / Photography: Iannos Kuhn

> LED PANELS

COMMERCIAL & ARCHITECTURAL

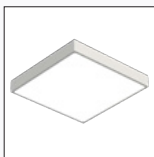

GLF04
pg 65

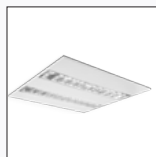

LEDP01
pg 66



LEDP03
pg 67



LLEDP03
pg 68



LLEDP0460638
pg 69



LLEDP041233840
pg 70

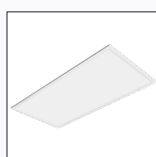

LLEDP041266040
pg 71



LLEDP13
pg 72



STELLAR
pg 73

> LINEAR LIGHTING

COMMERCIAL & ARCHITECTURAL

Surface / Linear
Suspended

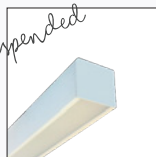

MINI BATTEN
pg 75



SKYWALKER 1
pg 76



SKYWALKER 2
pg 77



SKYWALKER 3
pg 78

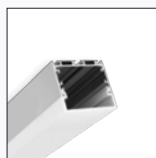

SKYWALKER 8
pg 79

Recessed
Linear



SKYWALKER 4
pg 80



SKYWALKER 5
pg 81

> LINEAR RETAIL LIGHTING

COMMERCIAL & ARCHITECTURAL



AISLE LIGHT
pg 83



LLED9
pg 84



XYRUS XX2
pg 85



XYRUS XX2 DBL
pg 86



> PENDANTS

COMMERCIAL

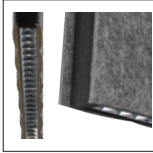

COLOR
pg 88



HONEYCOMB
pg 89



LP01
pg 90



LP05
pg 91



LP06
pg 92

ARCHITECTURAL

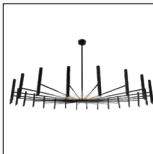

CLASSIC
pg 94



CLASSIC ELLIPSE
pg 95



FAIRY
pg 96

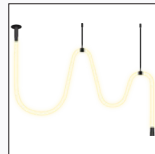

FILOLUCE P2
pg 97

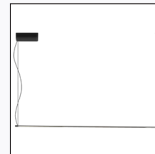

FLASH P
pg 99



FORMULIA
pg 100

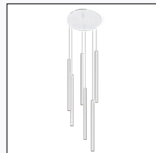

FORMULIA GROUP
pg 101



MELA P IN / ON
pg 102

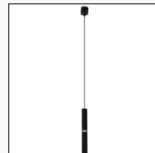

PROMEO
pg 103

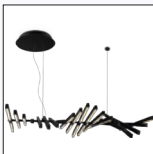

WAVE H S 20 DN
pg 104

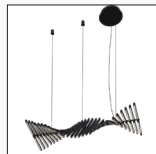

WAVE H S 30
pg 105



WAVE V L 30 UP
pg 106



LP18E27
pg 107



LP19E27
pg 108



LP20E27
pg 109

> CEILING

CEILING LIGHTS

CEILING – CEILING LIGHTS / RECESSED SPOTS

COMMERCIAL & ARCHITECTURAL



DOMO 2.1 ON
pg 111



DOMO 2.1 ON 2
pg 112



MOONY M
pg 113



MOONY M SPOT
pg 114



MOONY L
pg 115



MOONY L SPOT
pg 116



STUDIO
pg 117



LSD09
pg 118



LSD1627
pg 119

> RECESSED SPOTS

COMMERCIAL & ARCHITECTURAL

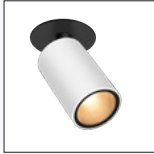

FAVOR INS
pg 121



LRS01
pg 122

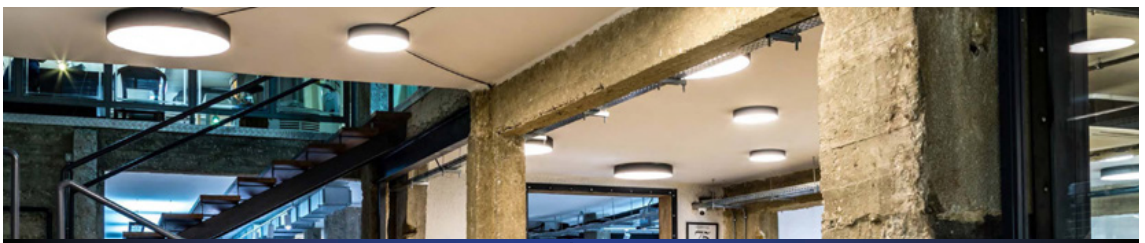

> SURFACE SPOTS

COMMERCIAL & ARCHITECTURAL

Surface Spot



**FAVOR ONL 18
REFLECTOR**
pg 124



FAVOR ONM ER
pg 125

GUI10



**DANNY MINI AIR
GU10**
pg 127



**DANNY MINI
SGR E1**
pg 128



**DANNY MINI
SGR E2**
pg 129



**DANNY MINI
SGR E3**
pg 130



DANNY SPOT
pg 131



DANNY SPOT DBL
pg 132



DANNY SPOT TRIPLE
pg 133



> DOWNLIGHTS - SURFACE

DOWNLIGHTS - SURFACE COMMERCIAL & ARCHITECTURAL / GU10

COMMERCIAL & ARCHITECTURAL



MOONY S
pg 135



MOONY S SPOT
pg 136



MOONY M
pg 137



MOONY M SPOT
pg 138



PEBUK M
pg 139



LSD01
pg 140

GU10



LSD05
pg 142

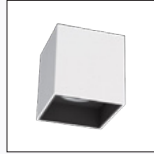

LSD06
pg 143



LSD062
pg 144



> DOWNLIGHTS - RECESSED

COMMERCIAL



LRD01
pg 146



LRD02
pg 147



LRD03
pg 148



LRD04
pg 149



LRD05
pg 150



LRD09
pg 151



LRD10
pg 152

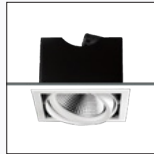

LRD12
pg 153

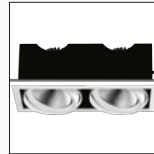

LRD122
pg 154



LRD13
pg 155



LRD14
pg 156



LRD142
pg 157



LRD16
pg 158



LRD16L
pg 159



LRD17
pg 160



LRD18
pg 161

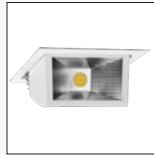

LRD20S
pg 162



LRD24
pg 163



LRD37
pg 164



LRD55
pg 165



ULTIMUM
pg 166

DOWNLIGHTS - RECESSED - COMMERCIAL

> ARCHITECTURAL

Recessed Spots



FAVOR INS R
pg 168



FAVOR INS R TRIMLESS
pg 169

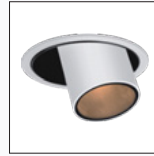

FAVOR INM R
pg 170

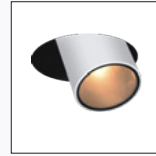

FAVOR INM R TRIMLESS
pg 171



FOCUS S14
pg 173



NIC S
pg 174

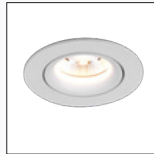

NIC S AD
pg 175



NIC M
pg 176



NIC M AD
pg 177



NIC L
pg 178

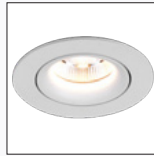

NIC L AD
pg 179

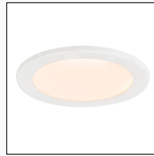

NIC S+ DEEP
pg 180



VISOR S
pg 181



VISOR M
pg 182



STUDIO
pg 183



VIRTUE
pg 184



MIRA
pg 185



TAYLOR
pg 186

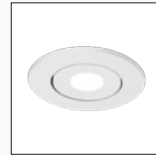

WANA RO
pg 187



RAY AISI316
pg 188



SLIM
pg 189

> **GU10**

GU10



LRD23GU1031
pg 191



LRD23GU10AD
pg 192



LRD23GU10IP
pg 193



LRD36
pg 194

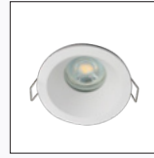

LRD52
pg 195



Project Cope Quarter

➤ TRACK & TRACK SPOTS

1-CIRCUIT 3-WIRE TRACK

Surface Track System



LBLT3
pg 197

Accessories

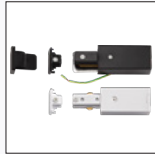

LBLT3PF
POWER FEED
pg 198

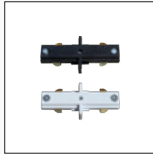

LBLT3IJ
I-JOINER
pg 198



LBLT3IC
I-CONNECTOR
pg 198



LBLT3LC
L-CONNECTOR
pg 198



LBLT3TC
T-CONNECTOR
pg 198



LBLT3XC
X-CONNECTOR
pg 198



LBLT3FC
FLEXI CONNECTOR
pg 198



LBLT3TA
TRACK ADAPTOR
pg 198

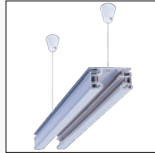

LBLT3ST
SUSPENSION TRACK
pg 198



LBLT3STK
SUSPENSION KIT
pg 198

> 1-CIRCUIT 3-WIRE TRACK SPOTS

GU10



LTL23GU10
pg 200



LTL24GU10
pg 201



LTL25GU10
pg 202



LTL26GU10
pg 203



LTL29GU10
pg 204



> 3-CIRCUIT TRACKS

Track System



3-CIRCUIT STANDARD
pg 206



3-CIRCUIT RECESSED
pg 209

Accessories

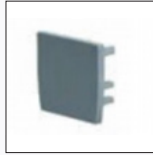

END COVER
pg 207



X-CONNECTOR
pg 207

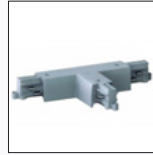

T-CONNECTOR L
pg 207

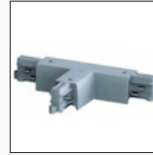

T-CONNECTOR R
pg 207



L-CONNECTOR
pg 207



MIDDLE CONNECTOR
pg 207



LEFT END FEED
pg 207

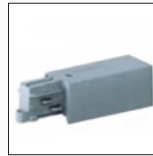

RIGHT END FEED
pg 207



MINI CONNECTOR
pg 207



FLEXIBLE CONNECTOR
pg 207



FLEX 60 CONNECTOR
pg 207



REINFORCEM. PLATE
pg 207



CEILING PROFILE
pg 207



SUSPENSION HOOK
pg 208



TRACK CLIP
pg 207



THREAD EXT JOINT
pg 208



R.P FOR WIRE SUSPENSION
pg 208



TRACK SUSPENSION
pg 208



TRACK CLIP WIRE/ROD
pg 208



ROD FOR WIRE SUSPENDED
pg 208

Surface Adaptor



SURFACE ADAPTOR
pg 207

COMMERCIAL & ARCHITECTURAL

TRACK & TRACK SPOTS - 3CIRCUIT TRACKS

> 3-CIRCUIT TRACK SPOTS

COMMERCIAL



ExO I
pg 212



ExO II
pg 213



LTL21
pg 214



**REVOC MINI
2000**
pg 215



REVOC 4000
pg 216



TUBIX MINI 2000
pg 217



TUBIX 3000/4000
pg 218



**ULTRA MINI
1500**
pg 219



ULTRA 3000
pg 220



**ZEN EVO
4000/5000**
pg 221



ZEN MINI 3000
pg 222

ARCHITECTURAL



DOMO T
pg 224



**REVOC MINI
2000**
pg 225



**ULTRA MINI
1500**
pg 226



ZEN MINI 3000
pg 227

GU10



**DANNY MINI
AIR T**
pg 229



LTL18GU10
pg 230

> LUNA S SURFACE MAGNETIC TRACK SYSTEM

Surface Track

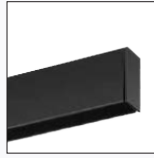

LUNA S ON SURFACE
pg 232

Accessories



LUNA S ON CORNER L1
pg 233



LUNA S ON CORNER L2
pg 233



LUNA S ON MOUNT CLIP L3
pg 233



LUNA S ON CONNECTOR
pg 234

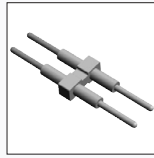

LUNA S/M PIN
pg 234



> LUNA S RECESSED MAGNETIC TRACK SYSTEM

COMMERCIAL & ARCHITECTURAL

Recessed Track



LUNA S DC RECESSED
pg 236

Accessories



LUNA S DC CORNER L1
pg 237



LUNA S DC CORNER L2
pg 237



LUNA S DC CORNER L3
pg 237



LUNA S DC CONNECTOR
pg 238

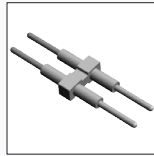

LUNA S/M PIN
pg 238

TRACK & TRACK SPOTS - MAGNETIC TRACK RECESSED

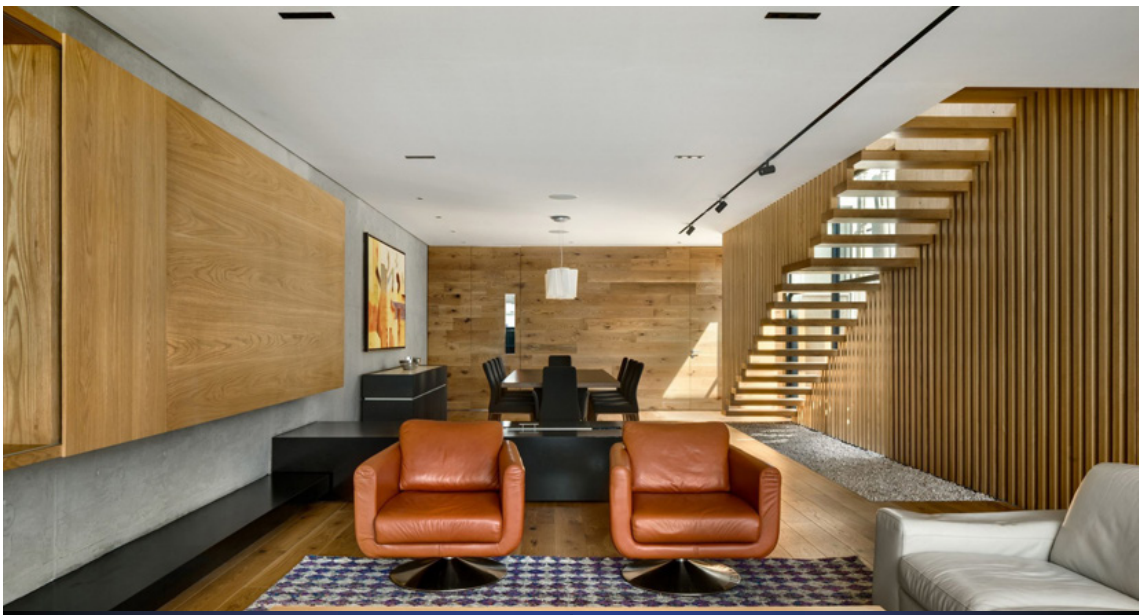

> LUNA S TRACK SPOTS



AHRI CS IN SPOT 3
pg 240

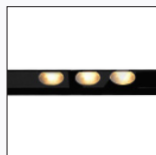

AHRI CS IN SPOT 3X1
pg 241



ARCA CS SPOT 7
pg 242

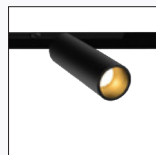

ARCA CS SPOT 10
pg 243



ARCA CS SPOT 12
pg 244

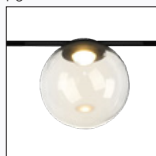

ELF CS
pg 245

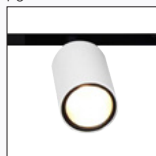

FAVOR CS S
pg 246

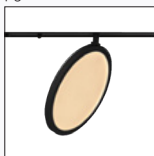

FLAT CS
pg 247

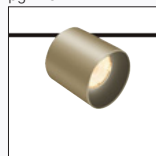

HUNTER CS M
pg 248

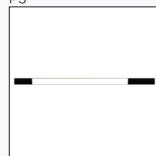

MOONLINE CS
pg 249

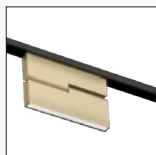

SHINY CS ON 5
pg 250



SHINY CS ON 10
pg 251

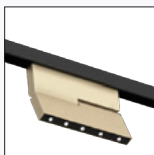

SHINY CS ON SPOT 5
pg 252



SHINY CS ON SPOT 10
pg 253



TURN CS MINI
pg 254



TURN CS S
pg 255



TURN CS S SQUARED
pg 256

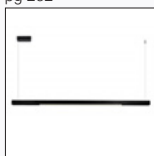

LUNA S P
pg 257

COMMERCIAL & ARCHITECTURAL

TRACK & TRACK SPOTS - MAGNETIC TRACK SPOTS

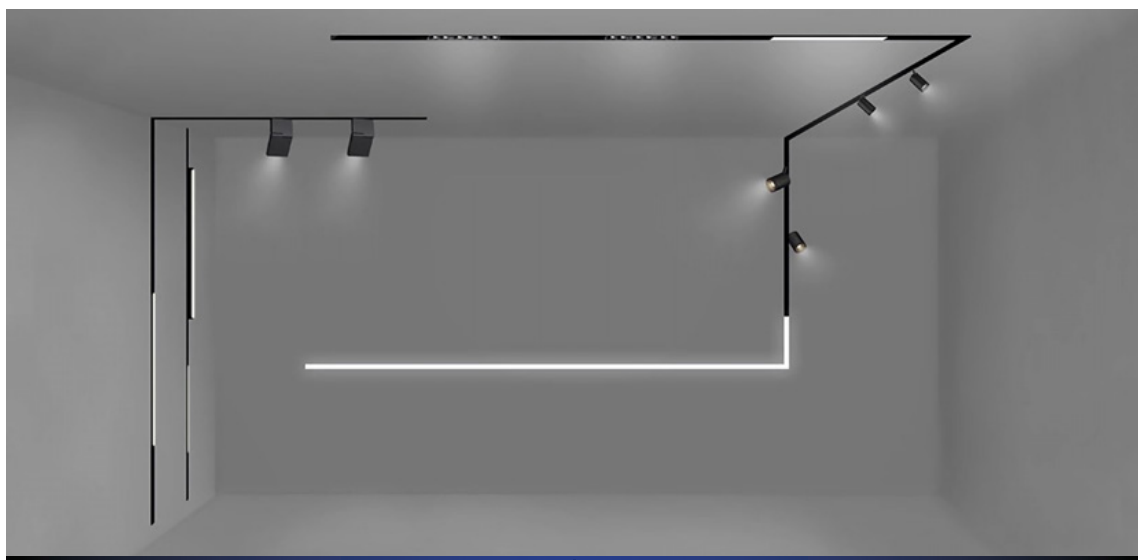

> LED STRIP LIGHTING

PROFILES & DIFFUSERS

COMMERCIAL & ARCHITECTURAL

Standard

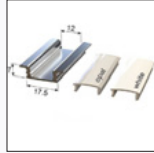

LBLEXTA4
pg 259

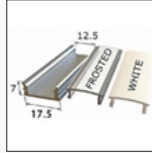

LBLEXTA6
pg 259



LBLEXTA10
pg 259

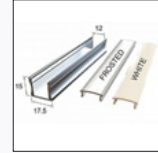

LBLEXTA11
pg 259

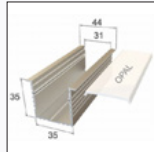

LBLEXTA12B
pg 259

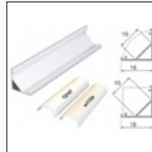

LBLEXTA13
pg 259

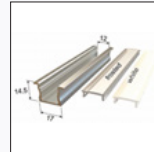

LBLEXTA15
pg 259

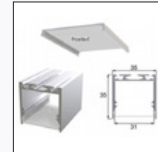

LBLEXTA48
pg 259

For Joinery

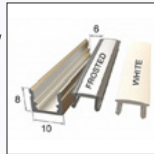

LBLEXTA18
pg 259

Bendable Profile

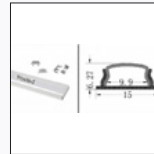

LBLEXTA54
pg 259

Accessories



END CAPS
pg 285



CLIPS
pg 285

> 24V LED STRIPS

Standard



LBLFLEX4.8
pg 261



LBLFLEX9.6
pg 262



LBLFLEX14.4
pg 263

Waterproof



LBLFLEXW4.8
pg 264



LBLFLEXW9.6
pg 265



LBLFLEXW14.4
pg 266

Special

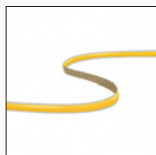

LBLFLEX5
pg 267



LBLFLEX10
pg 268

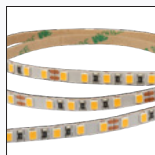

LBLFLEX100
pg 269

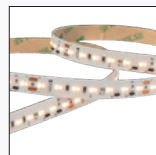

**LBLFLEX18
DTW224**
pg 270



**LBLFLEX18W
DTW224**
pg 271



**LBLFLEX14.4
RGB**
pg 272



**LBLFLEXW14.4
RGB**
pg 273

Neon Flex



LBLNEON6
pg 274



LBLNEON9.6
pg 275

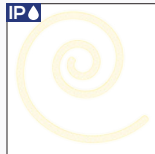

LBLNEON16
pg 276 - 283

COMMERCIAL & ARCHITECTURAL

LED STRIP LIGHTING - 24V STRIPS

> ACCESSORIES

COMMERCIAL & ARCHITECTURAL

Accessories



CONNECTORS
pg 285



CLIPS
pg 285



END CAPS
pg 285



MINI PIR SWITCH
pg 484



MAGNETIC SWITCH
pg 285



SUSPENSION CABLES
pg 285

> REMOTE CONTROLS

COMMERCIAL & ARCHITECTURAL

Remote Controls



LEDCTMM1
pg 287



LEDCTMM8
pg 288

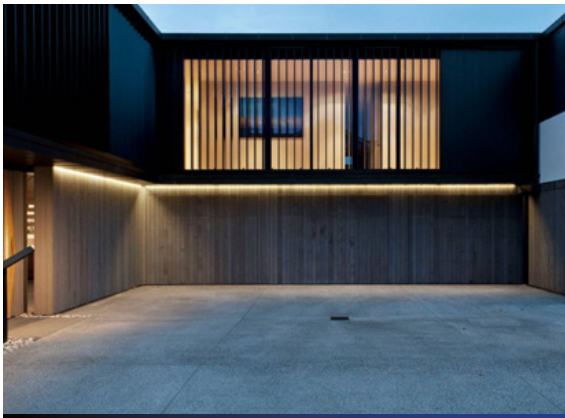

> DRIVERS

COMMERCIAL & ARCHITECTURAL



DIMMABLE
pg 289 - 294

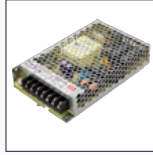

NON-DIMMABLE
pg 295 - 297



WATERPROOF
pg 298 - 300



> WALL

ART & MIRROR LIGHTING

COMMERCIAL & ARCHITECTURAL

Art



LBLPL0114
pg 302



LBLPL03
pg 303

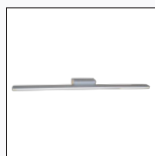

LBLPL04
pg 304

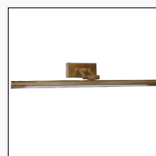

LBLP1028
pg 305

Bathroom



LBLBL015
pg 306



LBLBL029
pg 307



LBLBL03
pg 308



LBLBL04
pg 309



LBLBL05
pg 310



MIRO
pg 311

WALL - ART & MIRROR LIGHTING / ILLUMINATED MIRRORS

> ILLUMINATED MIRRORS

COMMERCIAL & ARCHITECTURAL



LBLML0120
pg 313



LBLML0212
pg 314

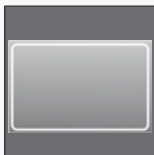

LBLML03
pg 315



LBLML0420W
pg 316



LBLML0520
pg 317

> BEDSIDE LIGHTING



BEL
pg 319



DONNA 1
pg 320



DONNA 3
pg 321

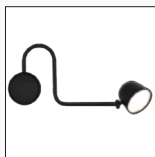

HYPNOS IN
pg 322



OTLY IN ROUND
pg 323



OTLY IN SQUARE
pg 324



TATOU IO BOX
pg 325



LBLWL013
pg 326



Project Labatessa Luxury Boutique Hotel, Cape Town

> DECORATIVE WALL LIGHTS

COMMERCIAL & ARCHITECTURAL



ADRAY RND
pg 328



ADRAY RND DBL
pg 329



ADRAY SQ
pg 330



ADRAY SQ DBL
pg 331

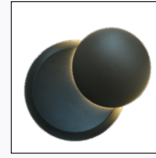

AUREOLE
pg 332

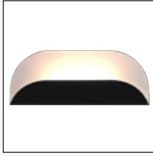

CURES LONG
pg 333

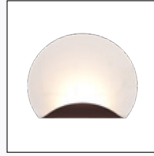

CURES ROUND
pg 334

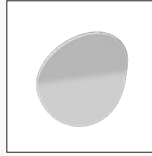

GEMO ROUND
pg 335



GEMO SQUARE
pg 336

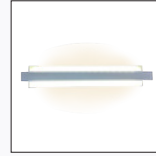

MIRO
pg 337

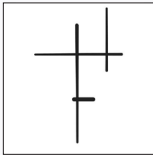

SONG C
pg 338

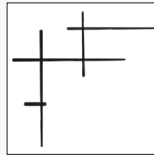

SONG D
pg 339

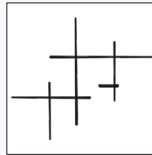

SONG E
pg 340

WALL - DECORATIVE WALL LIGHTS / INDOOR FOOTLIGHTS

> INDOOR FOOTLIGHTS

COMMERCIAL & ARCHITECTURAL



CARD IN1
pg 342



CARD IN2
pg 343



CARD SQ
pg 344



DANAS RO 3
pg 345



DANAS SQ 5
pg 346



SLIDE
pg 347



SLIDE IP
pg 348



SNOW
pg 349



TONE IN
pg 350

> FLOOR

FLOOR & TABLE LIGHTING

*Floor
Lighting*



COLUMN F
pg 352



**FLASH M V RO
SENSOR**
pg 353



HARI F
pg 354



SKIRT
pg 355

*Table
Lighting*



COSMOS
pg 357



FLOAT
pg 358



GLASSY
pg 359



SEPHORA V
pg 360



LBLTL01GU10
pg 361

COMMERCIAL & ARCHITECTURAL

FLOOR - FLOOR & TABLE LIGHTING / RECESSED UPLIGHTS



> RECESSED UPLIGHTS

COMMERCIAL & ARCHITECTURAL



LGL01
pg 363



LGL02
pg 364



MAX S
pg 365



> OUTDOOR POST TOPS



LLEDPT01
pg 367



LLEDPT02
pg 368

COMMERCIAL & ARCHITECTURAL

OUTDOOR - POST TOPS / BULKHEADS

> BULKHEADS



ORB
pg 370



LLEDBH01
pg 371



LLEDBH02
pg 372



LLEDBH06
pg 373

COMMERCIAL & ARCHITECTURAL

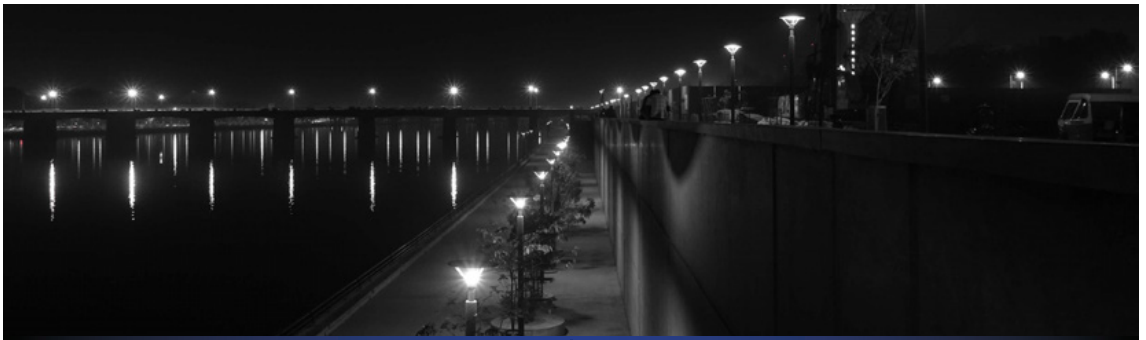

> WALL LIGHTS

COMMERCIAL & ARCHITECTURAL



APUS WR1
pg 375



APUS WR2
pg 376



APUS WS1
pg 377



APUS WS2
pg 378



CUBE SINGLE
pg 379



CUBE DOUBLE
pg 380

GU10



LWL15GU10
pg 382



LWL152GU10
pg 383



LWL16GU10
pg 384



LWL162GU10
pg 385

> LANTERNS

ARCHITECTURAL



LBLANT01
pg 387



LBLANT02
pg 388



LBLANT03
pg 389



LBLANT04
pg 390



LBLANT05
pg 391

> BOLLARDS



CRU H DOUBLE
pg 393



ETERNITY SGL
pg 394



ETERNITY DBL
pg 395



JOY
pg 396



WAY R
pg 397



LBOL1012
pg 398

COMMERCIAL & ARCHITECTURAL

OUTDOOR - BOLLARDS / FOOTLIGHTS

> FOOTLIGHTS



PACE LONG 2
pg 400



PACE SQUARED
pg 401



SLIDE IP AIS1316
pg 402



TEAR
pg 403



TONE IN
pg 404



TWILIGHT RECT
pg 405



TWILIGHT RND
pg 406



TWILIGHT SQ
pg 407



LFL04
pg 408

COMMERCIAL & ARCHITECTURAL



> FLOODLIGHTS

COMMERCIAL & ARCHITECTURAL



COSMIC
pg 410



HILUME
pg 411



HILUME PIR
pg 412



REMY
pg 413



LBLSL01
pg 414



LBLSL02
pg 415

> GARDEN SPIKES & SPOTS

COMMERCIAL & ARCHITECTURAL



CRU
pg 417



GADDIS M
pg 418



PICTOR SS
pg 419



PICTOR L
pg 420



SPARROW
pg 421



LLEDS02-3
pg 422



> BURIED UPLIGHTS

COMMERCIAL & ARCHITECTURAL



GT FROST DC
pg 424



LGL05
pg 425



MAX S
pg 426



MAX M
pg 427



SURROUND R1
pg 428



VELA XL
pg 429



**VELA ML
SQUARED DC**
pg 430

> WALL WASHERS & SPECIAL EFFECTS

COMMERCIAL & ARCHITECTURAL

Wall Washers



OCEAN
pg 432



**RIBBON S RGB
V2.0**
pg 433



**RIBBON M RGB
V2.0**
pg 434



**RIBBON L RGB
V2.0**
pg 435

Special Effects



MITILO
pg 437



TRICK RADIAL
pg 438

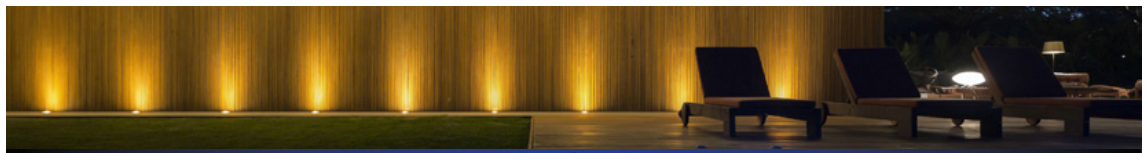

> EMERGENCY

EMERGENCY EXIT SIGNS

COMMERCIAL & ARCHITECTURAL



LEMGE01
pg 440



LEMGE02
pg 441



LEMGE03
pg 442



LEMGE04
pg 443



LEMGE09
pg 444

> EMERGENCY LIGHTS

COMMERCIAL & ARCHITECTURAL



LEMG01
pg 446

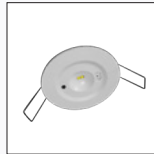

RCN4STO-01
pg 447



RDD1P5LC-01
pg 448



RDD1P5LO-01
pg 449



> EMG BATTERY PACKS

COMMERCIAL & ARCHITECTURAL



LED UNIVERSE
pg 451



**LED UNIVERSE
DELTA**
pg 452



Project: House Fischer / Lighting Design: Dominique Paronitti / Photography: Archigrahy

> LAMPS

COMMERCIAL & ARCHITECTURAL



GU10
pg 454



DELPHI
pg 455



GLS
pg 456 - 457



CANDLE / FLAME
pg 458 - 460



FILAMENT
pg 461 - 468



MAXI GLOBE
pg 469 - 471



GOLF BALL
pg 472



T-LAMP
pg 473



G9 BI-PIN
pg 474

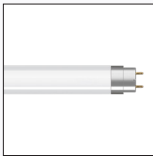

LED T5 TUBE
pg 475

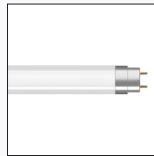

LED T8 TUBE
pg 476

LAMPS

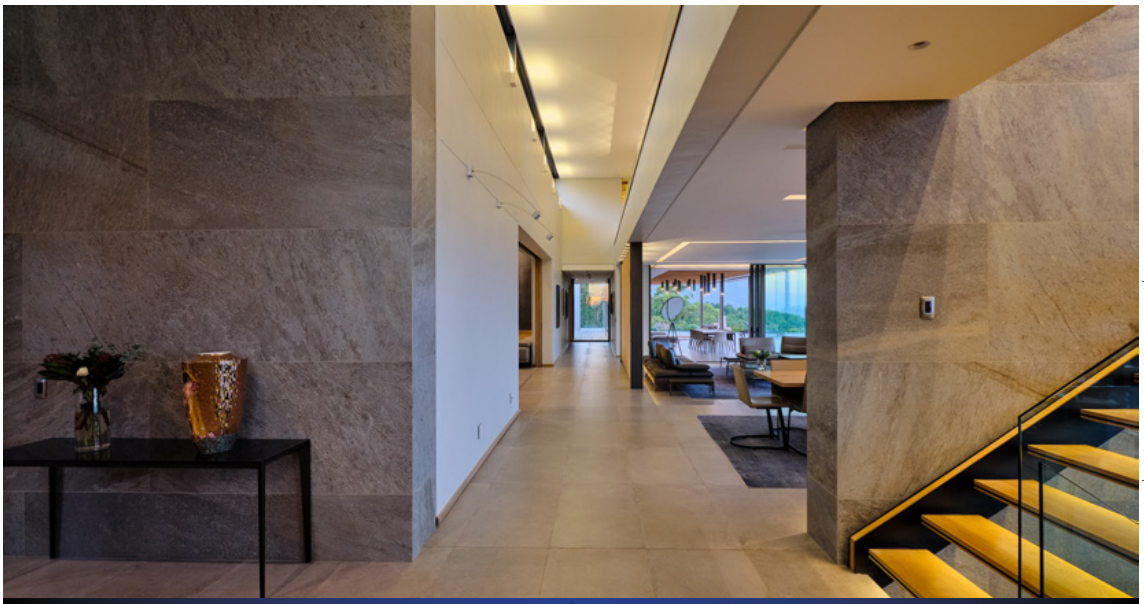

Project: House Fischer / Lighting Design: Dominique Pononitti / Photography: Archigraphy

> OTHER ACCESSORIES

Dimmers



**OSRAM
1-10V DIMMER**
pg 478



**SHUTTLE
DIMMER**
pg 479

*In Line
Connectors*

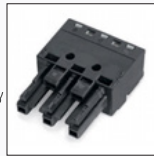

3-POLE PLUG
pg 480



5-POLE PLUG
pg 480



**3-POLE STRAIN
RELIEF HOUSING**
pg 480



5-POLE PLUG
pg 480



5-POLE SOCKET
pg 480



**3-POLE STRAIN
RELIEF HOUSING**
pg 480

COMMERCIAL & ARCHITECTURAL



Project: House Fischer / Lighting Design: Dominique Paronitti / Photography: Archigraphy

> SENSORS

COMMERCIAL & ARCHITECTURAL

Sensors



DAY / NIGHT SENSORS
pg 482



ALC15
pg 483



CD-IR-MS
pg 484



EBDHS
pg 485



EBDSM
pg 486



EBDSPIR
pg 487



EBMPIR-MB
pg 488



GEFL
pg 489



GESM
pg 490



MWS3A
pg 491



MWS6-UHS5
pg 492

Handsets



UHS5
pg 494



UNLCDHS
pg 495

OTHER – SENSORS & HANDSETS



Project: Ernie Els Winery / Interior Design: Rumour Has It / Photography: Charles Russell

Speciality LED Chips for Retail Lighting

TECHNICAL INFORMATION - SPECIALITY LED CHIPS - RETAIL LIGHTING



Red meat special LED

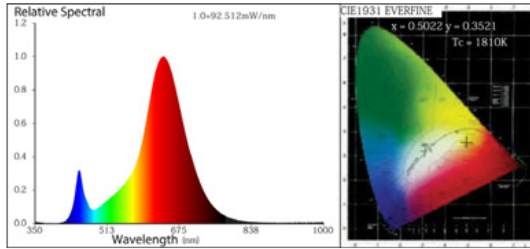

Bread special LED

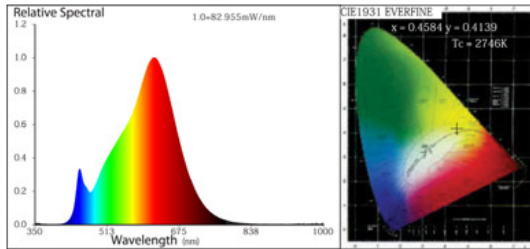

Fish special LED

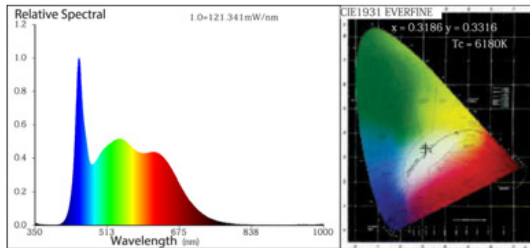

Vegetable special LED

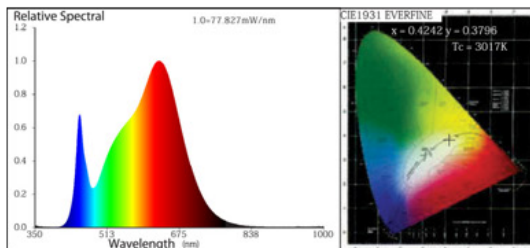

Fashion retails special LED

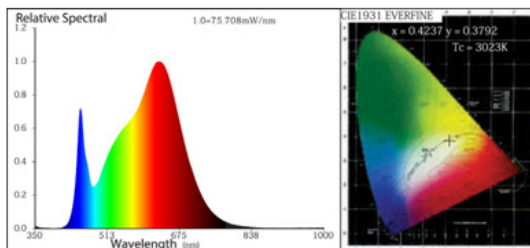

Besides the standard color rendering of >80 and >90, there are also special LED chips designed for red meat, bread and vegetable. These LEDs not only revert the natural color of the illuminated objects, but also accentuate the distinctive appeal of these goods to increase the purchase desire of the customers.



E&OE MAY OCCUR

TECHNICAL INFORMATION

SYMBOL DESCRIPTIONS

Technical Information and Symbols



Rotation angle in degrees



Adjustable in degrees



Tiltable in degrees



Cross Anti Glare Louvre



Barn Doors



Anti Glare Hood



Honeycomb Anti Glare diffuser



Mirro Reflector – 6% higher efficiency, 15% higher Central illumination, no electroplating pollution during production



SQUARE CUT OUT



ROUND CUT OUT - ϕ



Photometric data available on request.



To enable interchangeability of LED light sources, the Zhaga consortium has created several interface specifications for LED light engines covering different general lighting applications. LED modules with a central light emission and its associated electronic control gear.



CE marking is a mandatory conformity marking for certain products sold within the European Economic Area.



RoHS directive aims to restrict certain dangerous substances commonly used in electronic and electronic equipment.



LDT & IES are luminaire, data files used by professional light planning software for indoor and outdoor lighting. It stores lighting parameters for a luminaire, which include the number of lamps, the light intensity, the light distribution curve, and the size of the luminaire.



Luminaires are suitable for direct mounting on normally flammable surfaces.



CLASS I: Luminaires are electrically insulated and provided with an earth connection. Exposed metal that could become live in the event of basic insulation failure, is protected by earthing.



CLASS II: Luminaires are constructed so that protection against electric shock does not rely on basic insulation only, but also by providing additional safety precautions such as reinforced or double insulation. No provision for earth is provided.



CLASS III: Fixture delivered without transformer. Use with electronic transformers only.



Indicates x years warranty:
Extension to 5-year warranty available at additional cost. Standard Terms & Conditions apply.



Fire Rated Symbol

INGRESS RATING & ZONING

TECHNICAL INFORMATION

IP (INGRESS PROTECTION) RATING AND BATHROOM ZONING

WHAT IS IP RATING?

The resistance offered by the fixture to the penetration of solids and liquids is indicated by the IP (Ingress Protection) rating. This is a two digit number, the first number identifies the degree of protection against the ingress of solids and the second number against liquids e.g. IP65 indicates total protection against dust and protection against low pressure jets of water.

FIRST DIGIT	SECOND DIGIT	BATHROOM ZONES
Protection against solids 0 No protection 1 Protected against solid objects greater than 50mm (e.g. accidental contact with the hand) 2 Protected against solid objects greater than 12mm (e.g. accidental contact with finger) 3 Protected against solid objects greater than 2.5mm (e.g. tools and wires) 4 Protected against solid objects greater than 1mm (e.g. fine tools and wires) 5 Protected against dust 6 Total protection from dust	Protection against liquids 0 No protection 1 Protection against vertical water drops (e.g. condensation) 2 Protection against direct sprays of water, up to 15° from vertical 3 Protection against direct sprays of water, up to 60° from vertical 4 Protection against water spray from all directions 5 Protection against low pressure jets of water from all directions 6 Protection against jets of water of similar force to heavy seas 7 Protection against immersion between 15–100cm 8 Protection against submersion	Zone 0: Zone 0 is the interior of the bathtub or shower basin (the container). Zone 1: Zone 1 is limited by a) the vertical plane circumscribing the outer edge or 0,20m from the inner edge (where the ledge is too wide) of the bathtub, shower basin, or for a shower without a basin, by the vertical plane 0,60 m from the shower rose, and b) the horizontal plane 2,5 m above the bathtub or shower floor. Zone 2: Zone 2 Zone 2 is limited by a) the volume external to zone 1 and the parallel vertical plane 0,60 m external to zone 1, and b) the floor and the horizontal plane 2,25 m above the floor. Zone 3 Zone 3 is limited by a) the vertical plane external to zone 2 and the parallel vertical plane 2,40 m external to zone 2, and b) the floor and the horizontal plane 2,25 m above the floor.



Electrical equipment shall have at least the following degrees of protection against ingress of water in accordance with SANS 60529/ IEC 60529:

- A) in zone 0 : IPX8;
- B) in zone 1 : IPX5; IPX4 for swimming pools inside buildings which normally are not cleaned by means of jets;
- C) in zone 2 : IP22 for indoor locations; IPX4 for outdoor locations; IPX5 where water jets are likely to occur for cleaning purposes.

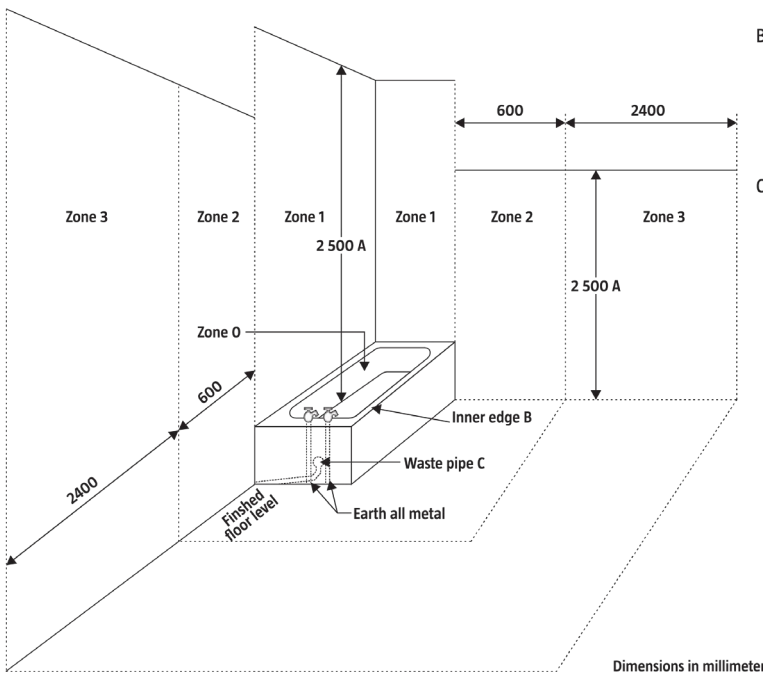

TECHNICAL INFORMATION - INGRESS RATING & ZONING

E&OE MAY OCCUR

TECHNOLOGY TERMS

TECHNICAL INFORMATION

New Technology Terms

- LED:** Short for light-emitting diode. An electronic semiconductor device that emits light when an electric current flows through it.
- R9 VALUE:** R9 is one of 6 saturated test colors not used in calculating CRI. Butchers, bakers, surgeons and fashion retailers among those who need their lights to render red really well.
- CRI:** Color Rendering Index is a quantitative measure of the ability of a light source to reveal the colors of various objects faithfully in comparison with an ideal or natural light source.
- LUMEN PER WATT RATIO:** Luminous efficacy is a measure of how well a light source produces visible light. It is the ratio of luminous flux to power.
- FLICKER RATE:** Unless a person is in natural daylight, they are likely to be exposed to this higher frequency flickering. Both mains-powered light sources, whether incandescent, halogen, fluorescent or LED, are subject to flickering. The AC component of the power supply and the frequency of the flickering is typically either equal to the mains frequency (usually 50 or 60 Hz) or double the mains frequency.

Lighting Terminology

- Photoelectric control:** Is a type of control which switches or dims lighting in response to the amount of incoming daylight.
- Presence detection:** Is a type of control which switches the lighting on when someone enters a space, and switches it off, or dims it, after the space becomes unoccupied.
- Absence detection:** Is a type of control which switches the lighting off, or dims it down, after the space becomes unoccupied. Switching on is done manually.
- Lamp lumens:** Means the sum of the average initial (1000 hour) lumen output of all the lamps in the luminaire.
- Lamp lumens per circuit-watt:** Is the total lamp lumens summed for all luminaires in the relevant areas of the building, divided by the total watts for all the luminaires.
- LOR:** Is the light output ratio of the luminaire, which means the ratio of the total light output of the luminaire under practical conditions to that of the lamp or lamps contained in the luminaire under reference conditions.
- Luminaire lumens per circuit-watt:** Is the (lamp lumens x LOR) summed for all luminaires in the relevant areas of the building, divided by the total watts for all the luminaires.

EMG Definitions

- Maintained lighting system:** An emergency lighting system requires two mains feeds: a permanent live connection and a switched live connection. The luminaire may be switched on and off with a healthy mains supply and the emergency control unit energises the lamp during a mains failure. The advantage of this system is that the luminaire can be used to provide normal lighting but the disadvantage is that the luminaire requires additional wiring.
- Non-maintained lighting system:** An emergency lighting system requires a single permanent mains supply. The luminaire cannot be used for normal lighting. In the event of a power failure the emergency control unit energises the lamp. The advantage of this system is that the lamp is not aged during normal mains conditions but the disadvantage is that the luminaire provides normal lighting.
- Self testing control unit:** An emergency control unit that automatically conducts regular tests to establish the condition of the lamp pack.
- Stand-by lighting:** Non-mandatory emergency lighting that is provided to enable normal activities to continue substantially during a power failure.
- Sustained lighting system:** An emergency lighting system requires a single permanent mains connection. The fluorescent lamp is energised from the mains supply and is powered by the emergency control unit during a power failure. The advantage of this system is that one live feed is required and the luminaire can provide normal lighting. The disadvantage of this system is that the luminaire must remain on permanently.

Code Building

Example:

CODE	WATTAGE	CCT	BEAM ANGLE	TRIM	LUMEN OUTPUT
LP01227	2 x 27 W	3000K / 3500K / 4000K	15° / 30° / 57°	31 20 30	6600 LM

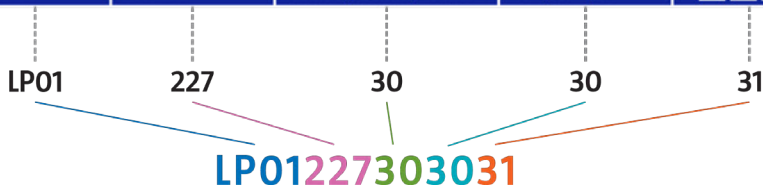

E&OE MAY OCCUR

➤ COMMERCIAL

HIGHBAYS & T-BAYS



HIGHBAY GEN 3

LED Highbay

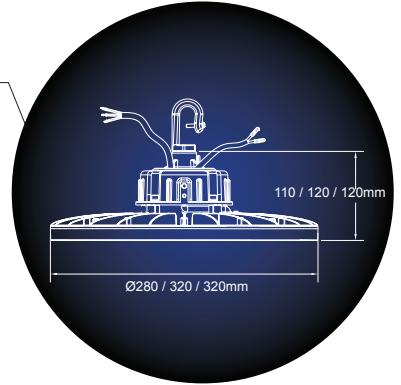
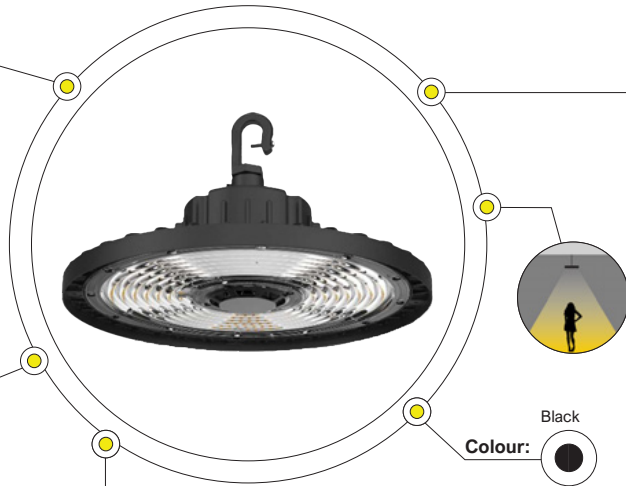

+ IP 65



LOA

3 YRS

ldt



PHYSICAL DATA

FEATURES

- Die-cast Aluminium Housing with PC front lens and an aluminium heat sink
- High efficiency heat dissipation
- Stainless steel screws and fittings
- Mounting hook
- Pre-wired with 500mm flying cable
- IK08 Impact rating (shock-resistance)
- Integrated LED Driver / 1-10V Dimming

- Surge Protection 4KV(L-N), 6KV(L,N-PE)

MOUNTING

Suspended, Surface

APPLICATION AREAS

Indoor, Outdoor, Commercial, Retail, Hospitality

TECHNICAL DATA

AC22868002M

AC22869002M

AC22911002M

	AC22868002M	AC22869002M	AC22911002M
LAMP	LED	LED	LED
TOTAL POWER (W)	120W	150W	200W*
SYSTEM OUTPUT (LM)	16800LM	21000LM	28000LM
EFFICACY (LM/W)	140	140	140
CCT (K)	4000K / 6500K	4000K / 6500K	4000K / 6500K
CRI (RA)	>80	>80	>80
BEAM ANGLE	90°	90°	70°
OPERATING VOLTAGE-VAC	100 - 277V	100 - 277V	100 - 277V
OPERATING TEMP °C	-30°C to +50°C	-30°C to +50°C	-30°C to +50°C
RATED LIFE (HRS)	50 000 HRS	50 000 HRS	50 000 HRS
POWER FACTOR	>0.9	>0.9	>0.9
DIMENSIONS	D:φ280 x H:110mm	D:φ320 x H:120mm	D:φ320 x H:120mm

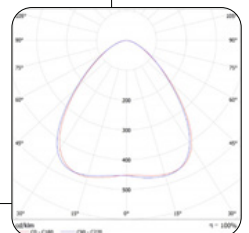

CD / KLM

C0 - C180

C90 - C270

E&OE MAY OCCUR

LHB03

HIGHBAY

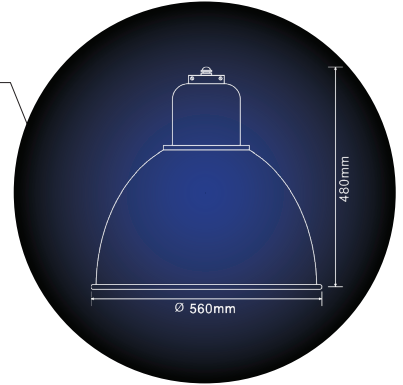
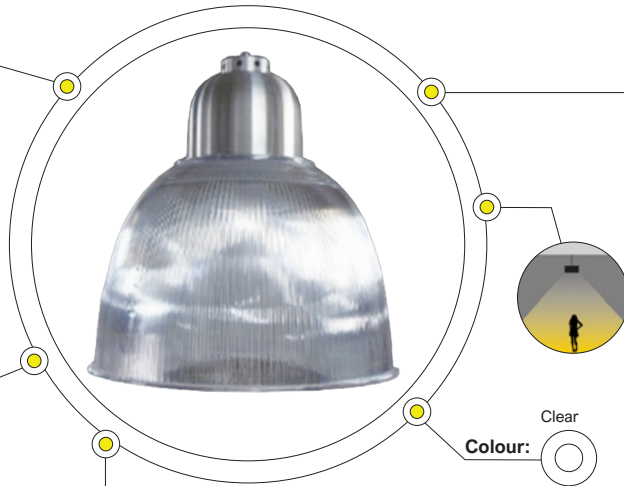

PHYSICAL DATA

FEATURES

- Material: Brushed aluminium top and ceiling cup
- UV stabilised, anti-glare acrylic reflector

MOUNTING

Suspended

APPLICATION AREAS

Indoor, Commercial, Retail, Hospitality

TECHNICAL DATA

LHB03

LAMP HOLDER	E40 CF
TOTAL POWER (W)	85W
OPERATING VOLTAGE-VAC	230V 50Hz
DIMENSIONS	D:φ560 (22") x H:480mm

LAMP DATA

G241

LAMP	MAXI SPIRAL COMPACT
BASE	E40 CFL
TOTAL POWER (W)	85W
TOTAL OUTPUT (LM)	4800LM
CCT (K)	6400K
CRI (RA)	80
RATED LIFE (HRS)	6000HRS
OPERATING VOLTAGE	220-240V
OPERATING TEMP °C	-20°C to +40°C



PLEASE NOTE

Lamp specifications and lamp warranties may differ

LLEDHB02

LED HIGHBAY

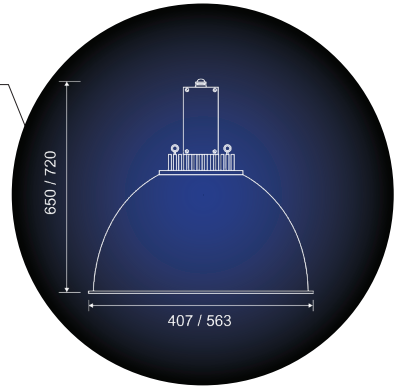
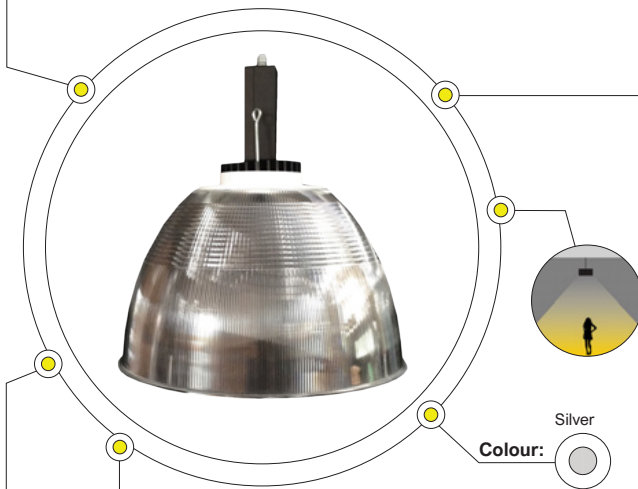

PHYSICAL DATA

FEATURES

- Material: Control chamber: Die-cast aluminium
- Reflector: Anodised aluminium or acrylic
- Standard on/off

MOUNTING

Suspended

OPTIONS & ACCESSORIES

- TRIAC, DMX and DALI dimming function on request
- 18" (D:407 x H:650mm) and 22" (D:563 x H:720mm) reflectors available for selection

APPLICATION AREAS

Indoor, Commercial, Retail, Hospitality

TECHNICAL DATA

LLEDHB0270

LLEDHB02146

LAMP	LED	LED
TOTAL POWER (W)	70W	146W
SYSTEM OUTPUT	8372 / 9100LM	17461 / 18980LM
EFFICACY (LM/W)	100	100
CCT (K)	3000 / 5000K	3000 / 5000K
CRI (RA)	80	80
BEAM ANGLE	WIDE BEAM	WIDE BEAM
OPERATING VOLTAGE-VAC	230V 50Hz	230V 50Hz
RATED LIFE (HRS)	50 000HRS	50 000HRS
R9 VALUE	>0.9	>0.9
MAC ADAM STEP	3 SDCM	3 SDCM

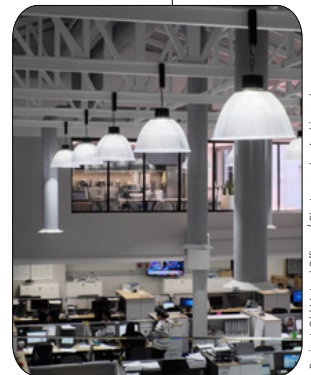

Project Old Mutual Offices / Photography: Archigraphy

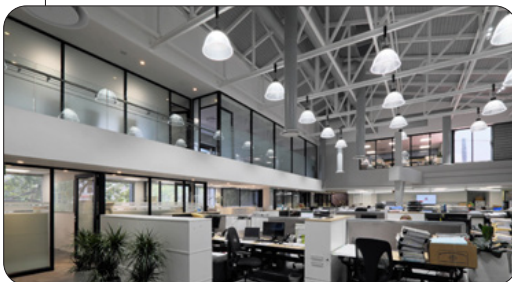

- CD / KLM
- C0 - C180
 - C90 - C270

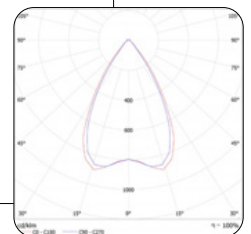

E&OE MAY OCCUR

LLEDSW6

LINEAR HIGHBAY

COMMERCIAL – HIGHBAY & T-BAY – LLEDSW6

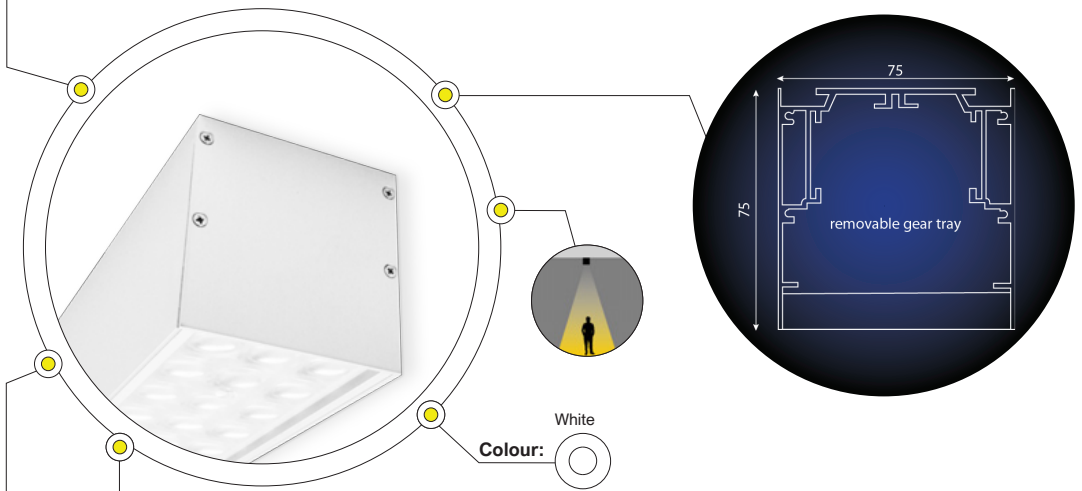

+ IP 20



5 YRS

ldt

PHYSICAL DATA

FEATURES

- Innovative thermal management employing passive cooling
- Maintenance by removable gear tray
- Built-in LED driver

- Smart-light control available
- Various beam angles available: 30° Narrow, 60° Wide, 90° Frosted, 110° Extra Wide, Asymmetrical, Symmetrical

OPTIONS & ACCESSORIES

- EMG 1hr or EMG 3hr available
- Dimmable options available

MOUNTING: Suspended or Surface

APPLICATION AREAS: Indoor, Commercial, Retail, Hospitality

TECHNICAL DATA

LLEDSW6

LAMP	LED
TOTAL POWER (W)	44-78W / 65-118W
SYSTEM OUTPUT (LM)	7050 - 13380LM 12075 - 20070LM
EFFICACY (LM/W)	175 - 193
CCT (K)	3000 - 6000K
CRI (Ra)	≥80
BEAM ANGLE	30° / 60° / 90° / 110° SYMMETRICAL ASYMMETRICAL
OPERATING TEMP °C	-20°C TO 45°C
TC CASE MAX TEMP °C	70°C TO 90°C
CURRENT (MA)	250 - 500MA
RATED LIFE (HRS)	50 000 HRS
POWER FACTOR	0.95
LUMEN MAINTENANCE	L90-B10
FLICKER FACTOR	<5%
DIMENSIONS	H:75 x W:75mm
LENGTH	1200 / 1800mm



Project Ernie Eis Winnes

- CD / KLM
- C0 - C180
 - C90 - C270

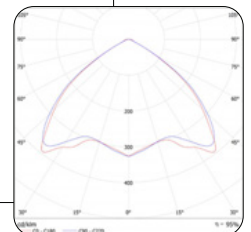

E&OE MAY OCCUR

LLEDTB02

LED T-BAY

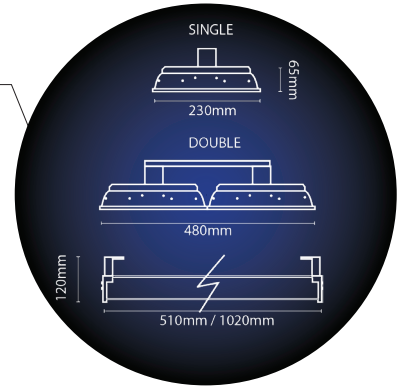

+ IP 44



3 YRS

ldt

PHYSICAL DATA

FEATURES

- Material: Stainless steel, ABS end caps, anodised aluminium reflectors, powder coated or anodised aluminium gear channel. Lens: 4mm Polycarbonate
- High efficiency LEDs
- 10KV surge arrester standard, Non- corrosive steel parts
- Mounting bracket for P2000 trunking or surface mounting to slab or from threaded rod

- Toughened glass lens type available on request
- 1-10V, DMX, DALI, KNX control protocols available
- Suspension kit, with clutch, available for easy suspension and height adjustment
- 90+ CRI, 2400K and 6500K available on request

MOUNTING: Surface

APPLICATION AREAS: Indoor, Commercial, Retail, Hospitality

OPTIONS & ACCESSORIES

TECHNICAL DATA

LLEDTB02

LAMP	LED
TOTAL POWER (W)	75W / 90W / 150W / 180W / 300W / 360W
SYSTEM OUTPUT (LM)	13200 / 15750 / 26400 / 31500 / 52800 / 63000 LM
EFFICACY (LM/W)	175
CCT (K)	3000 / 4000 / 5000K
CRI (Ra)	80
BEAM ANGLE	NARROW AND WIDE
OPERATING VOLTAGE-VAC	230V AC 50HZ
RATED LIFE (HRS)	50 000 HRS
FLICKER FACTOR	FLICKER FREE
R9 VALUE	0,9+
MAC ADAM STEP	3SDCM
SINGLE DIMENSIONS	L:510 x W:230 x 120mm
DOUBLE DIMENSIONS	L:1020 x W:480 x 120mm



NARROW

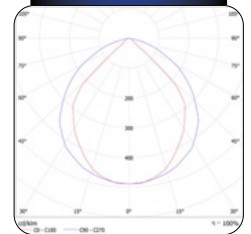

WIDE

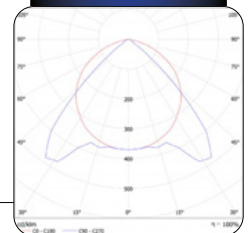

CD / KLM

● C0 - C180

● C90 - C270

E&OE MAY OCCUR

➤ UTILITY LIGHTS

COMMERCIAL & ARCHITECTURAL

COMMERCIAL - UTILITY LIGHTS

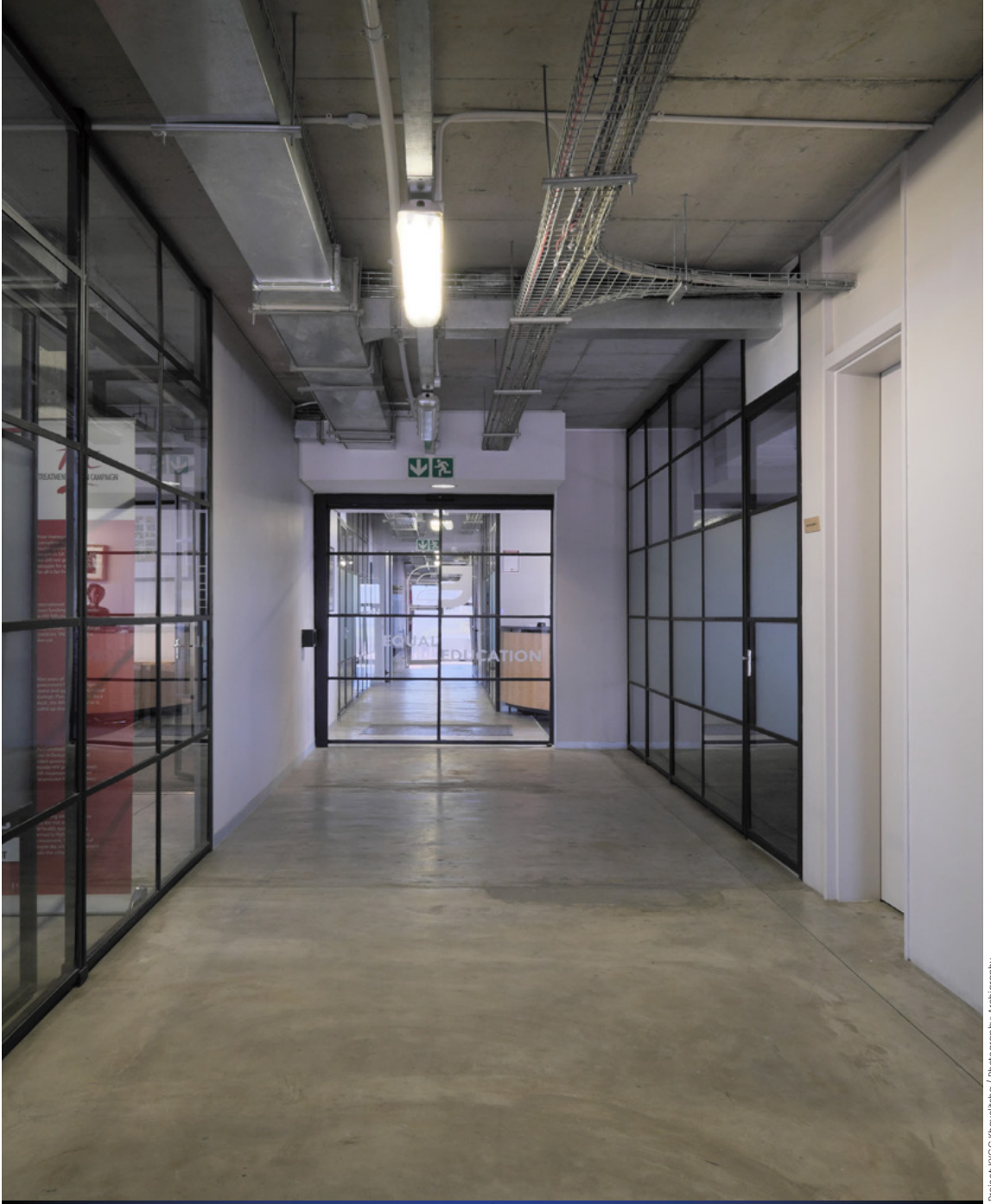

Project: KCC Khyelstar / Photography: Archigraphy

CAESAR

BATTEN

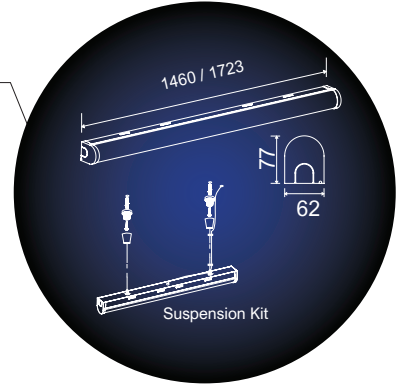
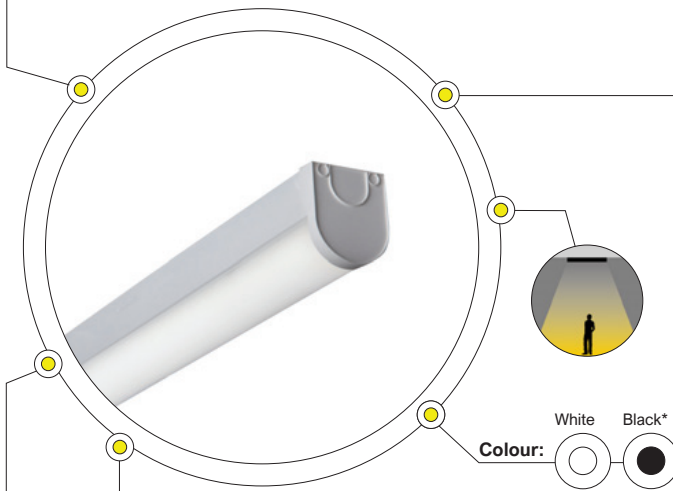

+ IP 20



LOA

5 YRS

ldt

PHYSICAL DATA

FEATURES

- Slim 2 piece body design - White powder coated pressed steel base housing the driver and mains connection block, and clip on metal framed opal diffuser with connector for LED's
- Maximises light output with good uniformity and reduced glare
- Makes energy savings of over 40%
- No disruption or maintenance costs for replacement tubes
- Phenomenal efficacy providing compliance with current & foreseeable legislation
- Utilises high quality long life surface mount 2835 SMD LED

- technology mounted on PCB substrate and plate which provides exceptional light output
- Has very low power consumption; Ensures lumen & CCT depreciation is minimized
- Provides an efficacy of ~116 luminaire lumens/circuit watt

MOUNTING: Surface or Suspended

APPLICATION AREAS: Indoor, Commercial, Retail, Hospitality

TECHNICAL DATA

RCA804015

RCA604018

RCA964018

LAMP	LED	LED	LED
TOTAL POWER (W)	78.5W	56.4W	96.4W
SYSTEM OUTPUT (LM)	8720LM	7140LM	11 260LM
EFFICACY (LM/W)	111	127	117
CCT (K)	4000K	4000K	4000K
CRI (RA)	80	80	80
BEAM ANGLE	140°	140°	140°
OPERATING VOLTAGE-VAC	220 - 240V	220 - 240V	220 - 240V
OPERATING TEMP °C	-25°C to +40°C	-25°C to +40°C	-25°C to +40°C
CURRENT (MA)	2000MA	1400MA	2 x 1200MA
RATED LIFE (HRS)	50 000HRS	50 000HRS	50 000HRS
R9 VALUE	14	14	14
UGR	29	30	32
MAC ADAM STEP	0.4	1.8	0.6
POWER FACTOR	0.97	0.97	0.97
ILLUM @ 1M (LUX)	2320	1900	3150
WEIGHT (KG)	2.5KG	3.1KG	3.2KG
DIMENSIONS	1460 x 62 x 77mm	1723 x 62 x 77mm	1723 x 62 x 77mm

* Special Order, MOQ applies

- CD / KLM
- C0 - C180
 - C90 - C270

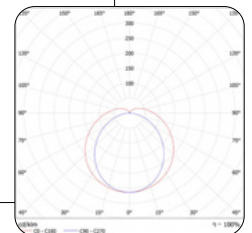

E&OE MAY OCCUR

EARL

UTILITY

COMMERCIAL - UTILITY LIGHTS - EARL

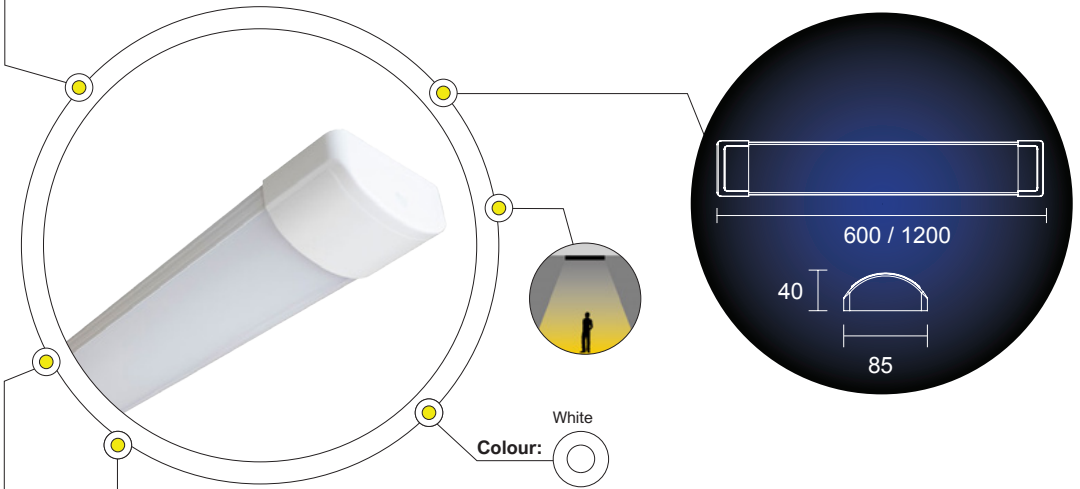

+ IP 20



LOA

3 YRS

ldt

COLOUR SELECTABLE

PHYSICAL DATA

FEATURES

- Material: Low profile aluminium housing with polycarbonate end caps and diffuser
- This linear LED batten is 3 Colour Temperature Selectable. Its slim attractive design looks good in any installation. It is also simple to install and provides massive energy savings with efficacies of up to 130 luminaire lumens per circuit watt to reduce CO2 emissions and the buildings carbon footprint
- Large screw terminal block allowing max 2.5mm conductors
- High-efficacy, wide operating ambient temperature

- Suitable for switching by PIR, Microwave or Photocell

OPTIONS & ACCESSORIES

- Different lengths and wattage options available

MOUNTING

Suspended

APPLICATION AREAS

Indoor, Commercial, Retail, Hospitality

TECHNICAL DATA

RER2006CCT3-01

RER4012CCT3-01

LAMP	LED	LED
TOTAL POWER (W)	19.2 / 18.4 / 19W	39.2 / 37.2 / 39.2W
SYSTEM OUTPUT (LM)	2010 / 2240 / 2160LM	3340 / 3960 / 3580LM
EFFICACY (LM/W)	105 / 122 / 113	85 / 106 / 91
CCT (K)	3000 / 4500 / 6500K	3000 / 4500 / 6500K
CRI (RA)	80	80
BEAM ANGLE	120°	120°
OPERATING VOLTAGE-VAC	220-240V	220-240V
OPERATING TEMP (°C)	-20°C to +40°C	-20°C to +40°C
RATED LIFE (HRS)	50 000HRS	30 000HRS
POWER FACTOR	0.95	0.9
ILLUM @ 1M (LUX)	610 / 680 / 650	960 / 1130 / 1020
WEIGHT (KG)	0.5KG	0.9KG
DIMENSIONS	W:85 x H:40 x L:600mm	W:85 x D:40 x L:1200mm

- CD / KLM
- C0 - C180
 - C90 - C270

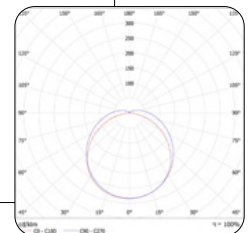

E&OE MAY OCCUR

HARBOUR

VAPOUR PROOF

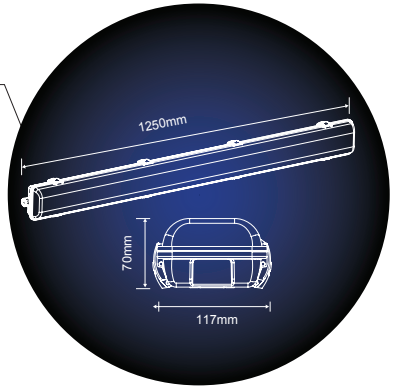
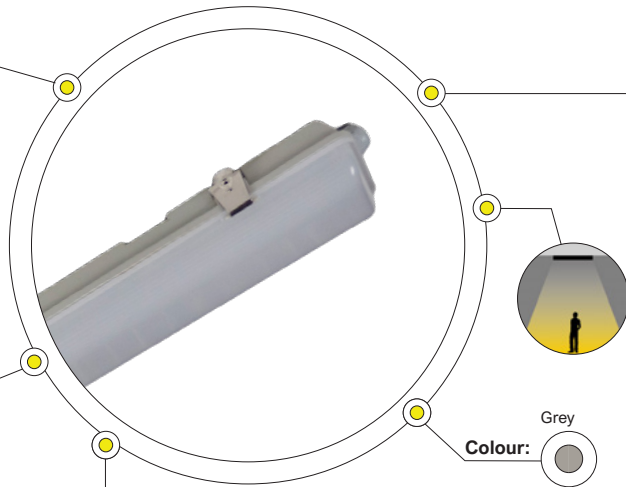

+ IP 65



LOA



ldt

PHYSICAL DATA

FEATURES

- Material: Grey coloured polycarbonate body with opal polycarbonate diffuser. Stainless steel clips and aluminium gear tray
- The base is flat-bottomed to aid mounting and is manufactured from high impact polycarbonate for strength and durability
- The base has reinforced glanding points in the base to aid gland or conduit entry
- High impact rating, High-efficacy, Corrosion-Proof

OPTIONS & ACCESSORIES

- Can easily be converted to emergency using Harbour 2W, 3hr Plug-In Emergency Pack with LifePo4 (RHA2WEMPK-PSU)
- Suitable for switching by PIR, Microwave or Photocell

MOUNTING: Surface

APPLICATION AREAS: Indoor, Outdoor, Commercial, Retail, Hospitality

TECHNICAL DATA

RHA40404FT-24

LAMP	LED
TOTAL POWER (W)	37.5W
SYSTEM OUTPUT (LM)	4280LM
EFFICACY (LM/W)	114
CCT (K)	4000K
CRI (RA)	80
BEAM ANGLE	120°
OPERATING VOLTAGE-VAC	220-240V
OPERATING TEMP (°C)	-20°C to 40°C
RATED LIFE (HRS)	50 000HRS
POWER FACTOR	0.97
ILLUM @ 1M (LUX)	1300
IMPACT RATING (IK)	IK08
WEIGHT (KG)	1.51KG
DIMENSIONS	W:117 x H:70 x L:1250mm

- CD / KLM
- C0 - C180
 - C90 - C270

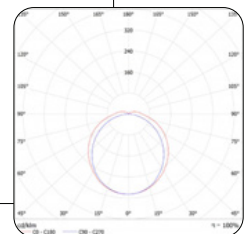

E&OE MAY OCCUR

LLEDB11

BATTEN

COMMERCIAL – UTILITY LIGHTS – LLEDB11

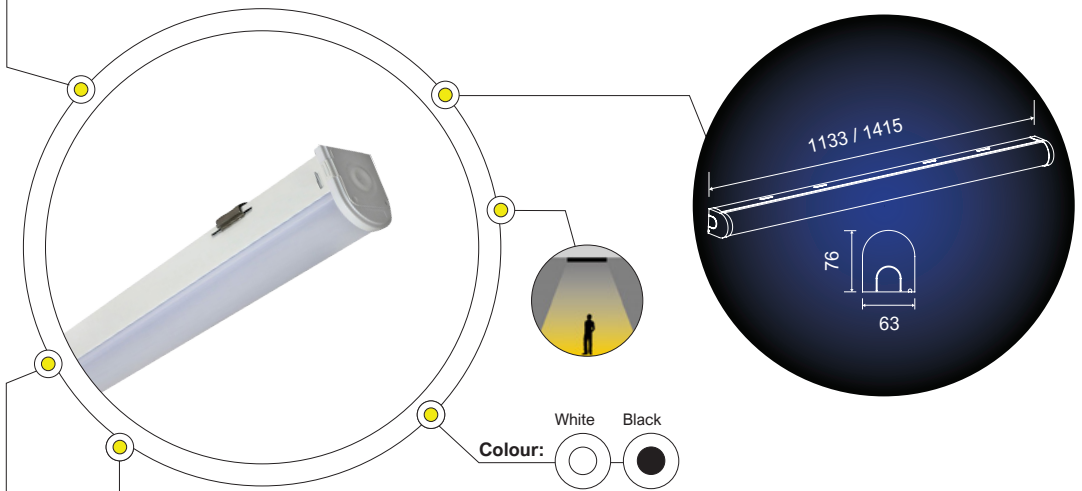

+ IP 20



LOA

3 YRS

ldt

PHYSICAL DATA

FEATURES

- Material: cold pressed steel, powder coated
- Diffuser Lens creates even soft lighting

MOUNTING

Surface

APPLICATION AREAS

Indoor, Commercial, Retail, Hospitality

TECHNICAL DATA

LLEDB1136

LLEDB1155

LLEDB1175

LAMP	LED	LED	LED
TOTAL POWER (W)	36W	55W	75W
SYSTEM OUTPUT	4000LM	6000LM	9500LM
EFFICACY (LM/W)	111	109	130
CCT (K)	4000K	4000K	4000K
CRI (RA)	80	80	≥80
BEAM ANGLE	120°	120°	120°
OPERATING VOLTAGE-VAC	220-240V	220-240V	220-240V
OPERATING TEMP °C	-20°C to 55°C	-20°C to 55°C	-20°C TO 50°C
RATED LIFE (HRS)	30 000 HRS	30 000 HRS	-20°C TO 40°C
CURRENT (MA)	290MA	370MA	370MA
LUMEN MAINTENANCE	L70B50	L70B50	L70B50
ILLUM @ 1M (LUX)	1191	1744	2735
POWER FACTOR	0.9	0.9	>0.9
R9 VALUE	13	13	10
UGR	>19	>19	>19
MAC ADAM STEP	1.3	2.5	2.5
WEIGHT (KG)	1.6KG	2KG	2.3KG
DIMENSIONS	L:1133 x W:63 x H:76mm	L:1415 x W:63 x H:76mm	L:1697 x W:63 x H:76mm

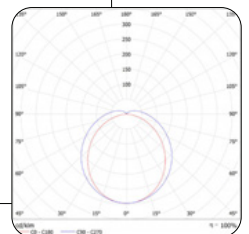
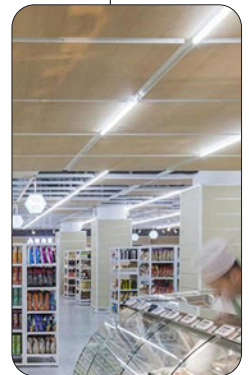

CD / KLM

C0 - C180

C90 - C270

E&OE MAY OCCUR

LLEDTP03

TRI-PROOF

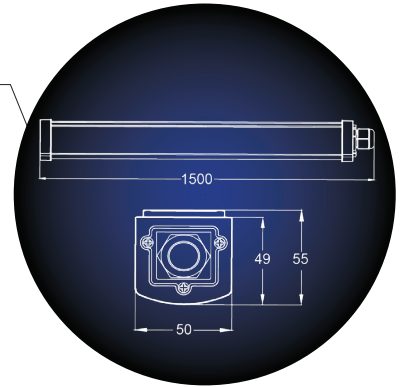
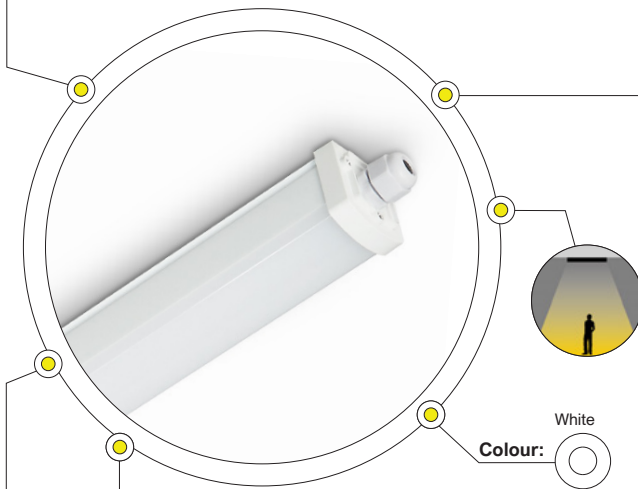

+ IP 65



LOA

5 YRS

ldt

PHYSICAL DATA

FEATURES

- Material: cold pressed steel, powder coated; Iron batten light, lightweight design
- Cover made from high gloss polycarbonate; Diffuser Lens creates even soft lighting
- It has a unique anti-mosquito structure design to ensure that there are no mosquitoes in the lamp after long-term use
- With a special structural design, the lamp body is

fastened to the lamp cover

OPTIONS & ACCESSORIES

- Mounting clips and screws

MOUNTING: Surface

APPLICATION AREAS: Indoor, Outdoor, Commercial, Retail, Hospitality

TECHNICAL DATA

LLEDTP03

LAMP	LED
TOTAL POWER (W)	50W
SYSTEM OUTPUT (LM)	5500LM
EFFICACY (LM/W)	110
CCT (K)	4000K
CRI (Ra)	≥80
BEAM ANGLE	120°
OPERATING VOLTAGE-VAC	220-240V
OPERATING TEMP °C	-20°C TO 50°C
AMBIENT TEMP °C	-20°C TO 40°C
CURRENT (MA)	460MA
POWER FACTOR	>0.9
LUMEN MAINTENANCE	L70B50
UGR	>19
THD	<20%
IMPACT RATING (IK)	IK06
FLICKER FACTOR	<5%
WEIGHT	720g
DIMENSIONS	L:1500 x W:50 x H:55mm

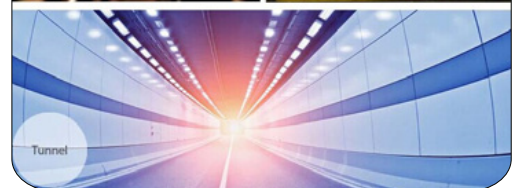
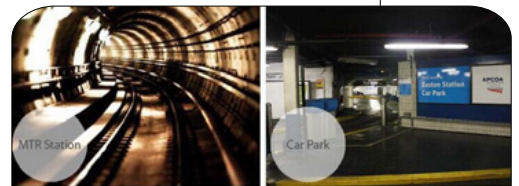

- CD / KLM
- C0 - C180
 - C90 - C270

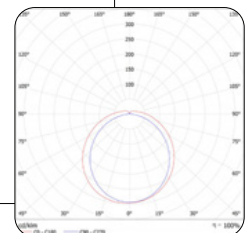

E&OE MAY OCCUR

> LED PANELS

COMMERCIAL & ARCHITECTURAL

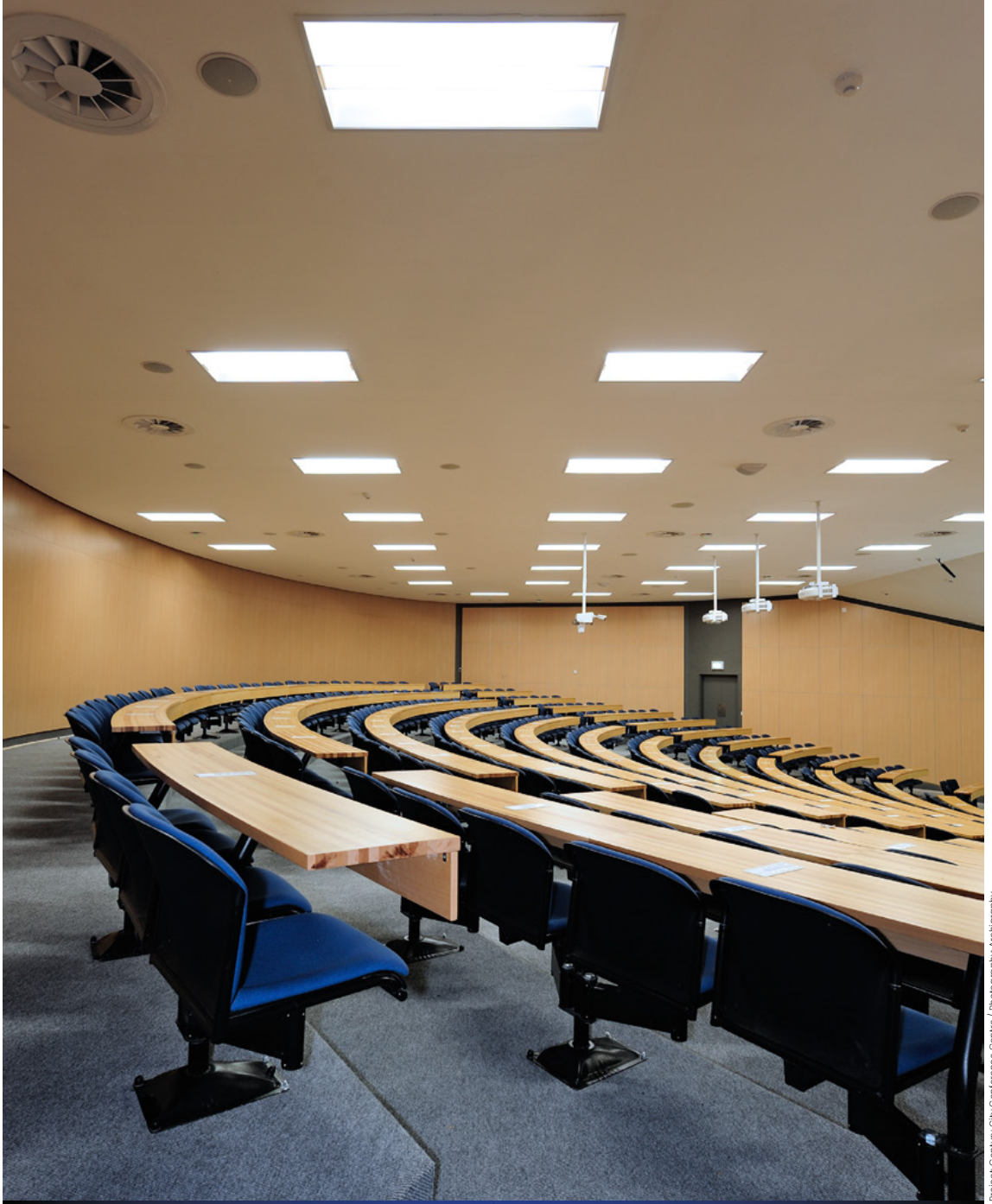

Project Century City Conference Centre / Photography: Archigrophy

GLF04

LED PANELS

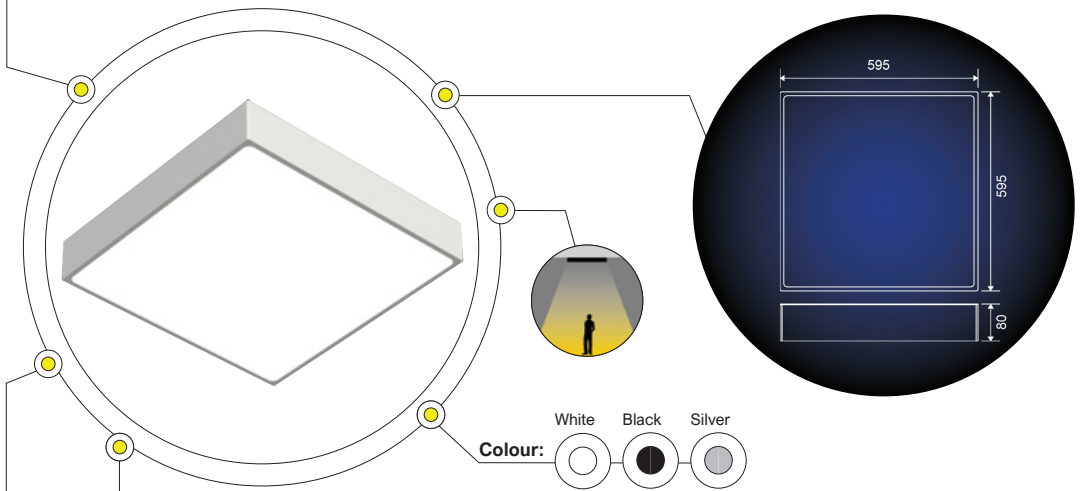

+ IP 20



5 YRS

ldt

PHYSICAL DATA

FEATURES

- Flame retardant ABS
- High output LED Panel
- Removable lens for easy cleaning
- Frosted Opal 80% transmission
- Prismatic Clear 90% transmission

- Control Tunable white - 2700K and 6500K optional
- Dimmable - Dali, 1-10v, DMX

MOUNTING

Recessed / Surface / Suspended with Suspension Kits

APPLICATION AREAS

Indoor, Commercial, Retail, Hospitality

OPTIONS & ACCESSORIES

- RGBW Colour changing optional

TECHNICAL DATA

GLF04 42W

GLF04 70W

LAMP	LED	LED
TOTAL POWER (W)	42W	70W
SYSTEM OUTPUT (LM)	5340LM	9900LM
EFFICACY (LM/W)	128	128
CCT (K)	3000 / 4000 / 5000K	3000 / 4000 / 5000K
CRI (Ra)	>80	>80
BEAM ANGLE	Wide Beam	Wide Beam
OPERATING VOLTAGE-VAC	220-240V	220-240V
OPERATING TEMP °C	-30°C TO 55°C	-30°C TO 55°C
RATED LIFE (HRS)	50 000HRS	50 000HRS
R9 VALUE	0,9	0,9
MAC ADAM STEP	3 SDCM	3 SDCM
DIMENSIONS	L:595 x W:595 x H:80mm	L:595 x W:595 x H:80mm

- CD / KLM
- C0 - C180
 - C90 - C270

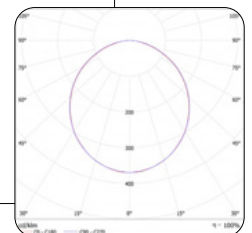

E&OE MAY OCCUR

LEDP01

LED PANELS

COMMERCIAL – LED PANELS – LEDP01

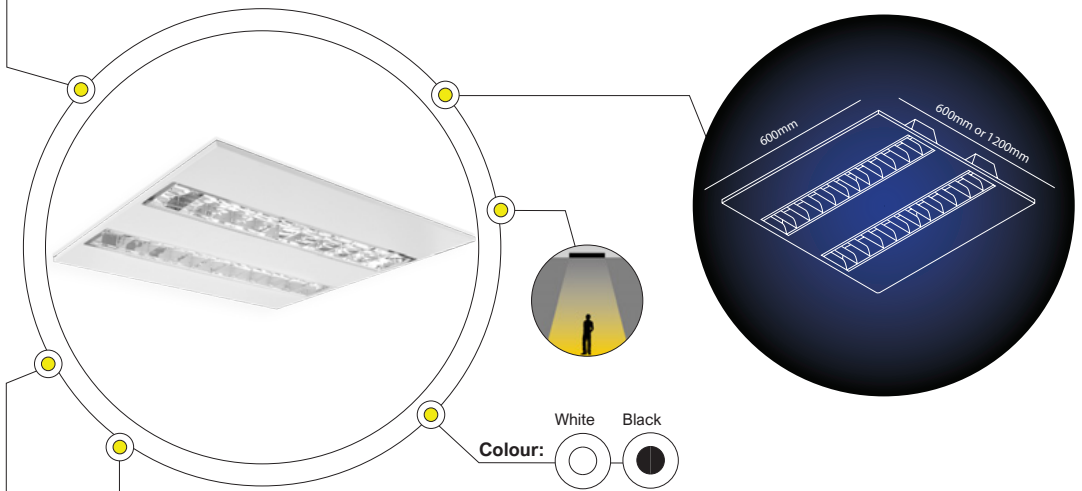

+ IP 20



3 YRS

ldt

PHYSICAL DATA

FEATURES

- Material: Cold rolled steel housing with PMMA Opal diffuser and ABS louvers
- Drivers to be installed remotely

- Other CCT (K) available
- Available in 600x600mm or 600x1200mm

OPTIONS & ACCESSORIES

- EMG 1hr or EMG 3hr available
- DALI, Occupancy Control, Daylight Harvesting, Time Switch Control and Bluetooth options available

MOUNTING

Recessed

APPLICATION AREAS

Indoor, Commercial, Retail, Hospitality

TECHNICAL DATA

LEDP01-3K

LEDP01-4K

LAMP	LED	LED
TOTAL POWER (W)	22 / 32 / 47W per m	22 / 32 / 47W per m
SYSTEM OUTPUT (LM)	3951 / 5501 / 8061LM	4284 / 5883 / 8155LM
EFFICACY (LM/W)	178 / 173 / 173	193 / 185 / 175
CCT (K)	3000K	4000K
CRI (Ra)	>80	>80
BEAM ANGLE	80°	80°
	DOUBLE PARABOLIC	DOUBLE PARABOLIC
OPERATING VOLTAGE-VAC	220-240V	220-240V
CURRENT (MA)	250 / 350 / 500MA	250 / 350 / 500MA
RATED LIFE (HRS)	50 000HRS	50 000HRS
POWER FACTOR	0.95	0.95
LUMEN MAINTENANCE	L80-B10	L80-B10
FLICKER FACTOR	<5%	<5%
MAC ADAM STEP	3 SDCM	3 SDCM
WEIGHT (KG)	3.44KG (600X600mm) 6.10KG (600x1200mm)	3.44KG (600X600mm) 6.10KG (600x1200mm)

- CD / KLM
- C0 - C180
 - C90 - C270

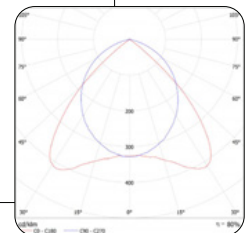

E&OE MAY OCCUR

LEDP03

LED PANELS

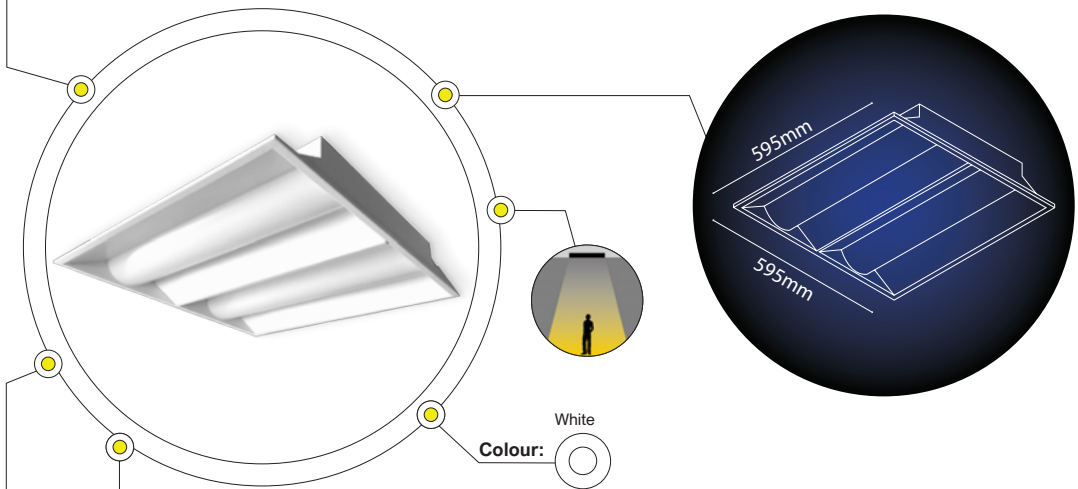

+ IP 20



5 YRS

ldt

PHYSICAL DATA

FEATURES

- Material: Cold rolled steel housing with PMMA diffuser
- Drivers to be installed remotely

MOUNTING

Recessed

OPTIONS & ACCESSORIES

- EMG 1hr or EMG 3hr available
- DALI, Occupancy Control, Daylight Harvesting, Time Switch Control and Bluetooth options available
- Other CCT (K) available

APPLICATION AREAS

Indoor, Commercial, Retail, Hospitality

TECHNICAL DATA

LEDP03-3K

LEDP03-4K

LAMP	LED	LED
TOTAL POWER (W)	22 / 32 / 47W per m	22 / 32 / 47W per m
SYSTEM OUTPUT (LM)	3951 / 5501 / 8061LM	4284 / 5883 / 8155LM
EFFICACY (LM/W)	178 / 173 / 173	193 / 185 / 175
CCT (K)	3000K	4000K
CRI (Ra)	>80	>80
BEAM ANGLE	120°	120°
OPERATING VOLTAGE-VAC	220-240V	220-240V
CURRENT (MA)	250 / 350 / 500MA	250 / 350 / 500MA
RATED LIFE (HRS)	50 000HRS	50 000HRS
POWER FACTOR	0.95	0.95
LUMEN MAINTENANCE	L80-B10	L80-B10
FLICKER FACTOR	>5%	<5%
MAC ADAM STEP	3 SDCM	3 SDCM
WEIGHT (KG)	3.36KG	3.36KG

- CD / KLM
- C0 - C180
 - C90 - C270

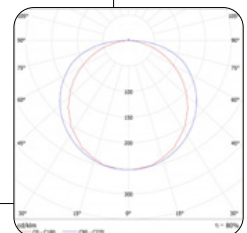

E&OE MAY OCCUR

LLEDP03

LED PANELS

COMMERCIAL - LED PANELS - LLEDP03

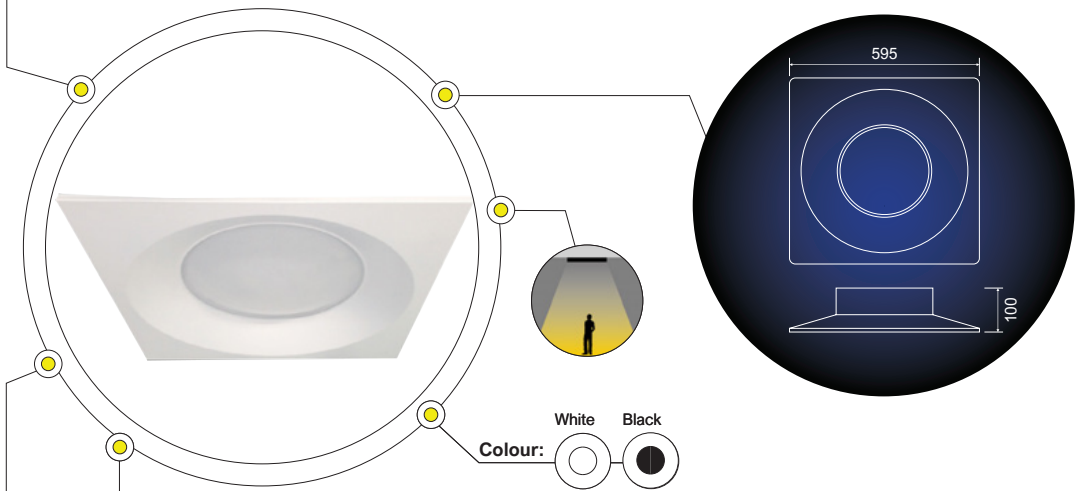

+ IP 20



5 YRS

ldt

PHYSICAL DATA

FEATURES

- ABS Body
- Acrylic - frosted with 80% transmission or prismatic clear with 90% transmission
- Floating External Control Gear

MOUNTING

Recessed

APPLICATION AREAS

Indoor, Commercial, Retail, Hospitality

OPTIONS & ACCESSORIES

- Surface mount available
- Dimmable - Dali, 1-10v, DMX

TECHNICAL DATA

LLEDP03

LAMP	LED
TOTAL POWER (W)	30 / 42W
SYSTEM OUTPUT (LM)	3870LM / 5418LM
EFFICACY (LM/W)	129
CCT (K)	3000K / 4000K / 5000K
CRI (Ra)	80
BEAM ANGLE	180°
OPERATING VOLTAGE-VAC	220-240V
OPERATING TEMP °C	-30°C to +55°C
RATED LIFE (HRS)	50 000HRS
R9 VALUE	0,9
MAC ADAM STEP	3 SDCM
DIMENSIONS	L:595 X W:595 X H:100mm



Project Meici Clinic, Stellenbosch / Lighting Design: Lianko Kuhn

- CD / KLM
- C0 - C180
 - C90 - C270

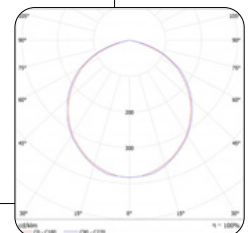

E&OE MAY OCCUR

LLEDP0460638

LED PANELS

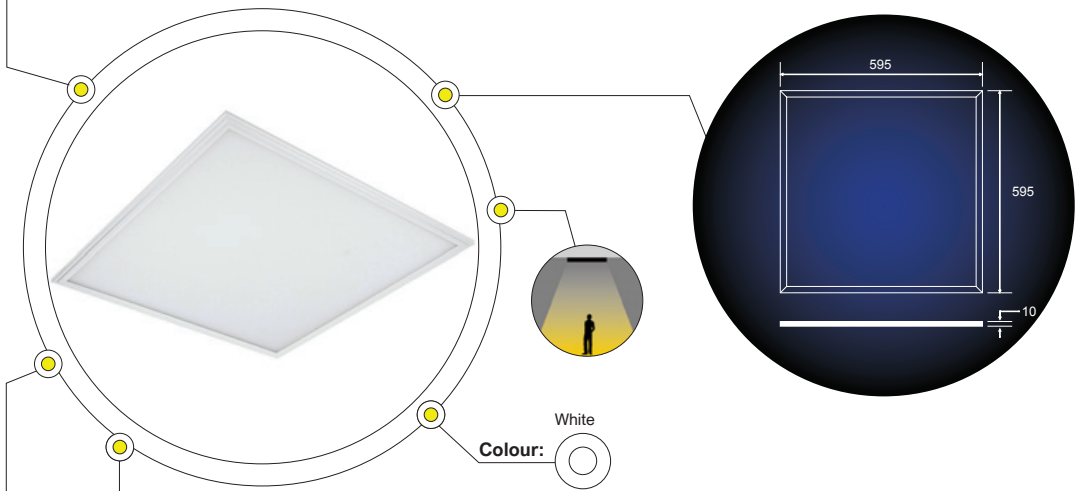

+ IP 20



LOA

5 YRS

ldt

PHYSICAL DATA

FEATURES

- Slim with clean lines with a white powder coat finish aluminium trim.
- Easy to clean and less likely to harbor germs or dirt and match most ceiling tile and grid T-bar colours
- A high quality PP thermoplastic diffuser ensures that light transmission is maximized into the lit space
- Reduces glare allowing the fittings to comply with the UGR required for small offices and corridors

MOUNTING

Recessed / Surface (with use of surface mount box)
Suspended (with use of suspension kits) as optional accessories

APPLICATION AREAS

Indoor, Commercial, Retail, Hospitality

TECHNICAL DATA

LLEDP046063830

LLEDP046063840

LLEDP046063850

LAMP	LED	LED	LED
TOTAL POWER (W)	38W	38W	38W
SYSTEM OUTPUT (LM)	3390LM	3800LM	3800LM
EFFICACY (LM/W)	89	99	101
CCT (K)	3000K	4000K	5000K
CRI (RA)	80	80	80
BEAM ANGLE	110°	110°	110°
OPERATING VOLTAGE-VAC	220-240V	220-240V	220-240V
OPERATING TEMP °C	-20°C to +40°C	-20°C to +40°C	-20°C to +40°C
CURRENT (MA)	850MA	850MA	850MA
RATED LIFE (HRS)	50 000 HRS	50 000 HRS	50 000 HRS
POWER FACTOR	0.97	0.97	0.97
MAC ADAM STEP	1.9	1	2
R9 VALUE	-4	0	-1
UGR	≤19	≤19	≤19
ILLUM @1M (LUX)	1070	1310	1310
WEIGHT (KG)	2KG	2KG	2KG
DIMENSIONS	L:595 x W:595 x H:10mm	L:595 x W:595 x H:10mm	L:595 x W:595 x H:10mm

R6060SMKB-01



ATMOS surface mount box kit
Allows for wall/ ceiling mounting
Driver concealed behind the fitting or located behind the wall/ceiling void

RAMSUS4W-R

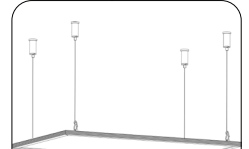

ATMOS Suspension Kit
Length: 1200mm

E&OE MAY OCCUR

LLEDP041233840

LED PANELS

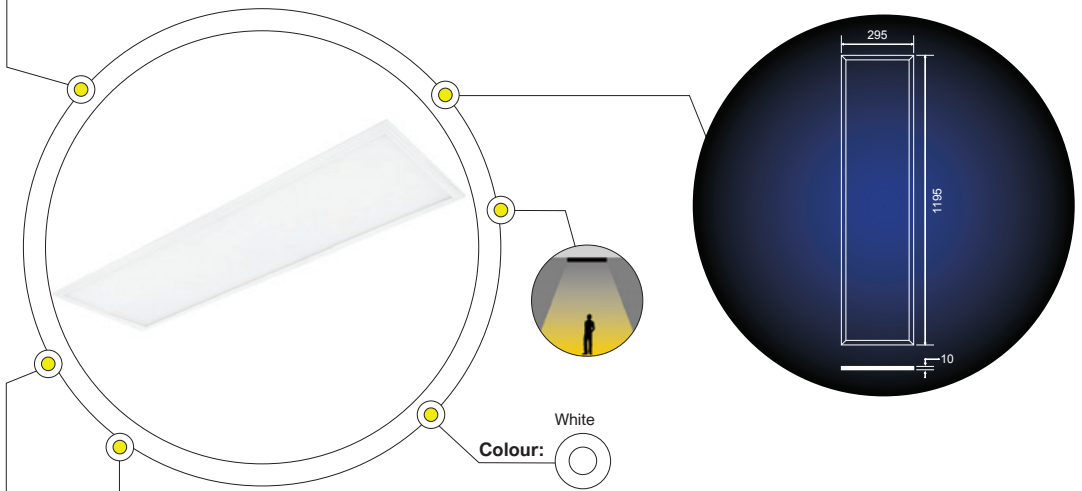

PHYSICAL DATA

FEATURES

- There's a full range of sizes and lumen packages available to provide a solution for most applications and ceiling grid layouts
- Slim with clean lines with a white powder coat finish aluminium trim.
- Easy to clean and less likely to harbor germs or dirt and match most ceiling tile and grid T-bar colours
- A high quality PP thermoplastic diffuser ensures that light transmission is maximized into the lit space

- Reduces glare allowing the fittings to comply with the UGR required for small offices and corridors

MOUNTING:

Recessed / Surface (with use of surface mount box)
Suspended (with use of suspension kits) as optional accessories

APPLICATION AREAS

Indoor, Commercial, Retail, Hospitality

+ IP
20



LOA

5 YRS

ldt

TECHNICAL DATA

LLEDP041233840

LAMP	LED
TOTAL POWER (W)	37.5W
SYSTEM OUTPUT (LM)	3730LM
EFFICACY (LM/W)	100
CCT (K)	4000K
CRI (Ra)	80
BEAM ANGLE	110°
OPERATING VOLTAGE-VAC	220-240V
CURRENT (MA)	850MA
OPERATING TEMP °C	-20°C to +40°C
RATED LIFE (HRS)	50 000HRS
POWER FACTOR	0.97
ILLUM @1M (LUX)	1290LX
R9 VALUE	9
UGR	≤19
MAC ADAM STEP	3.5 SDCM
WEIGHT (KG)	2.4KG
DIMENSIONS	L:1195 x W:295 x H:10mm

***Special order, MOQ applies

CD / KLM

● C0 - C180

● C90 - C270

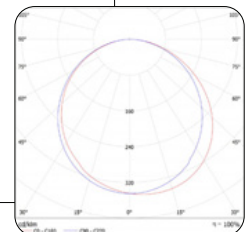

E&OE MAY OCCUR

LLEDP041266040

LED PANELS

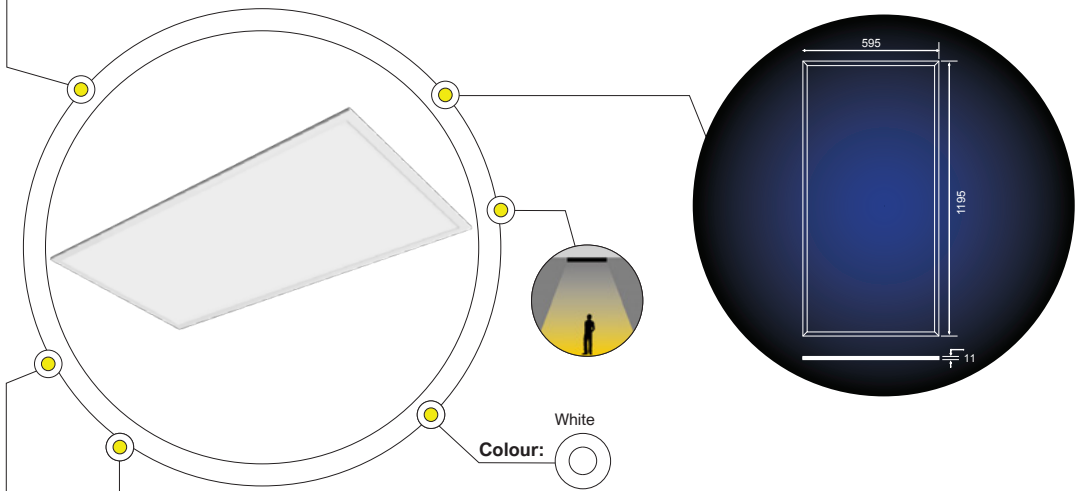

+ IP 20



LOA

5 YRS

ldt

PHYSICAL DATA

FEATURES

- There's a full range of sizes and lumen packages available to provide a solution for most applications and ceiling grid layouts
- Slim with clean lines with a white powder coat finish aluminium trim
- Easy to clean and less likely to harbor germs or dirt and match most ceiling tile and grid T-bar colours
- A high quality PP thermoplastic diffuser ensures that light transmission is maximized into the lit space

- Reduces glare allowing the fittings to comply with the UGR required for small offices and corridors

MOUNTING:

Recessed / Surface (with use of surface mount box)
Suspended (with use of suspension kits) as optional accessories

APPLICATION AREAS

Indoor, Commercial, Retail, Hospitality

TECHNICAL DATA

LLEDP041266040

LAMP	LED
TOTAL POWER (W)	60.8W
SYSTEM OUTPUT (LM)	6620LM
EFFICACY (LM/W)	109
CCT (K)	4000K
CRI (Ra)	80
BEAM ANGLE	120°
OPERATING VOLTAGE-VAC	220-240V
CURRENT (MA)	850MA
OPERATING TEMP °C	-20°C to +40°C
RATED LIFE (HRS)	50 000HRS
POWER FACTOR	0.97
UGR	≤19
ILLUM @1M (LUX)	2110LX
WEIGHT (KG)	5KG
DIMENSIONS	L:1195 x W:595 x H:11mm

***Special order, MOQ applies

- CD / KLM
- C0 - C180
 - C90 - C270

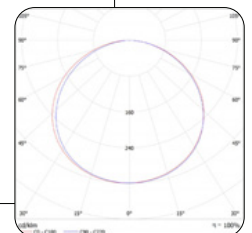

E&OE MAY OCCUR

LLEDP13

LED PANELS

COMMERCIAL - LED PANELS - LLEDP1340/55

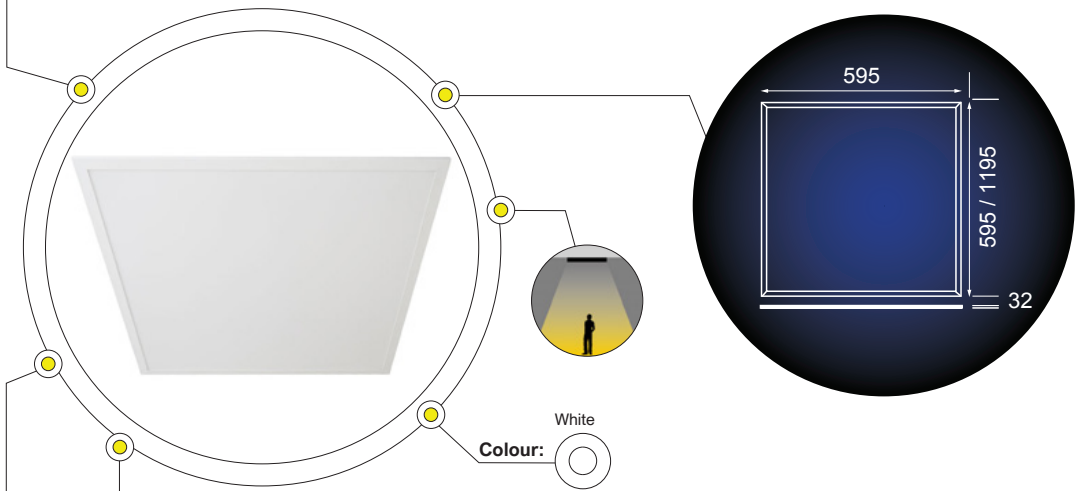

+ IP 20



LOA



ldt

PHYSICAL DATA

FEATURES

- Material: Aluminium frame with polystyrene diffuser with iron backsheet
- Back-lit panel
- Isolated driver
- Flicker free

MOUNTING

Recessed

APPLICATION AREAS

Indoor, Commercial, Retail, Hospitality

TECHNICAL DATA

LLEDP1340

LLEDP1355

	LLEDP1340	LLEDP1355
LAMP	LED	LED
TOTAL POWER (W)	40W	55W
SYSTEM OUTPUT (LM)	4000LM @ 4000K	6000LM @4000K
EFFICACY (LM/W)	100	100
CCT (K)	3000 / 4000 / 6500K	3000 / 4000 / 6500K
CRI (Ra)	>80	>80
BEAM ANGLE	110°	110°
OPERATING VOLTAGE-VAC	220-240V	220-240V
OPERATING TEMP °C	-20°C to 40°C	-20°C to 40°C
CURRENT (MA)	1000MA	1000MA
RATED LIFE (HRS)	50 000HRS	50 000HRS
POWER FACTOR	>0.9	>0.9
MAC ADAM STEP	<6 SDCM	<6 SDCM
UGR	≤22	≤22
R9 VALUE	>0	13.6
LUX	550	550
DIMENSIONS	L:595 x W:595 x H:32mm	L:1195 x W:595 x H:32mm

CD / KLM

C0 - C180

C90 - C270

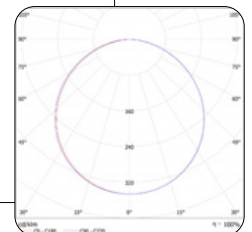

E&OE MAY OCCUR

STELLAR

LED PANELS

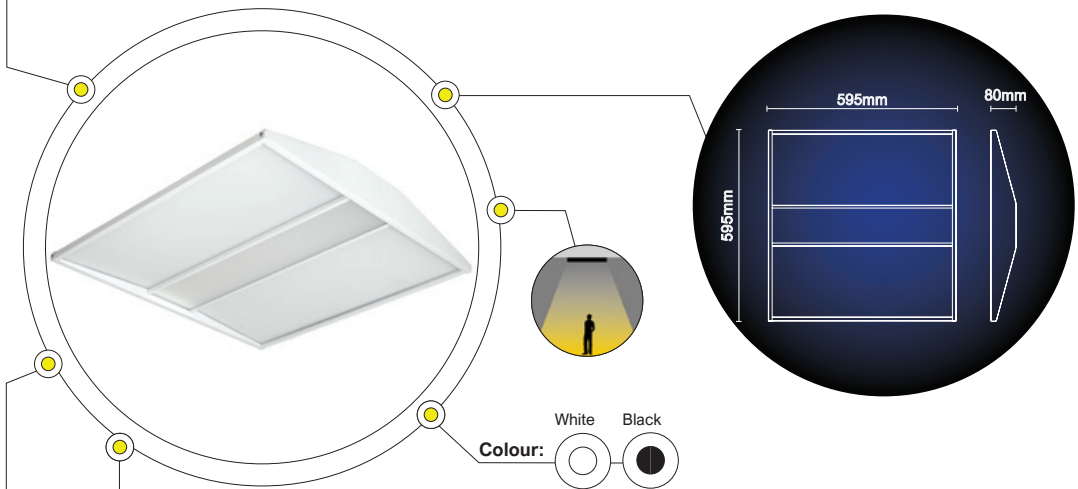

+ IP 20



LOA

5 YRS

ldt

PHYSICAL DATA

FEATURES

- LED replacement for 4x18W T8 lay-in panels
- Fits into standard sizes of ceiling grid - 15mm and 24mm
- High impact rating of IK06
- Luminance <math><3000\text{cd/m}^2</math> at <math><65^\circ</math> for ease of screen viewing
- Pre-wired enabling fast fix installation
- Suitable for switching by PIR, Microwave or Photocell

OPTIONS & ACCESSORIES

- Available in TRIAC / DALI / 1-10V
- Round / Square Trims / Trimless version available
- Emergency option is also available
- Plug and play emergency pack - R3EMPK4-PSU available

MOUNTING: Recessed

APPLICATION AREAS: Indoor, Commercial, Retail

TECHNICAL DATA

RSL2840606001

LAMP	LED
TOTAL POWER (W)	28W
SYSTEM OUTPUT (LM)	3200LM
EFFICACY (LM/W)	113
CCT (K)	4000K
CRI (Ra)	80
BEAM ANGLE	80°
OPERATING VOLTAGE-VAC	220-240V
CURRENT (MA)	700MA
OPERATING TEMP °C	-20°C to +40°C
RATED LIFE (HRS)	50 000HRS
POWER FACTOR	0.95
ILLUM @1M (LUX)	1880LX
R9 VALUE	14
UGR	17
MAC ADAM STEP	2.6 SDCM
WEIGHT (KG)	3KG
DIMENSIONS	L:595 X W:595 X H:80mm

- CD / KLM
- C0 - C180
 - C90 - C270

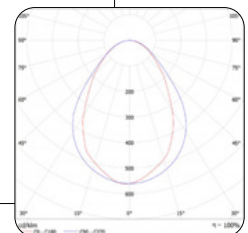

E&OE MAY OCCUR

➤ LINEAR LIGHTING

COMMERCIAL & ARCHITECTURAL

COMMERCIAL - LINEAR LIGHTING



Project Food Lovers Market

MINI BATTEN

**SURFACE/SUSPENDED
LINEAR LIGHTING**

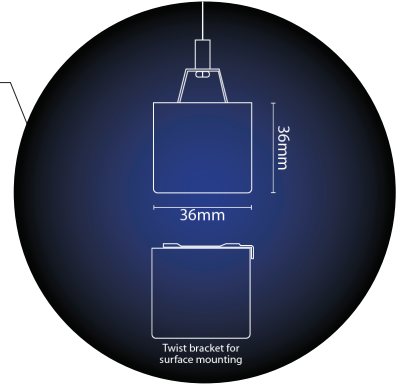
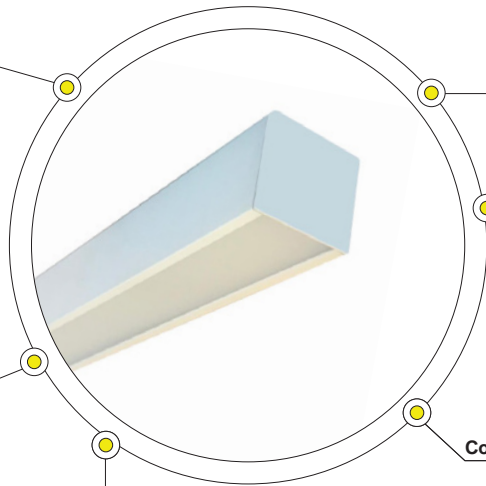

+ IP 20



5 YRS

ldt

PHYSICAL DATA

FEATURES

- Material: Extruded aluminium; either anodized or powder coated
- Opal Lens standard
- Bracket for surface mount, creates 'shadow line'
- Twist lock bracket for surface mounting
- Pieces can be joined to make longer runs up to 5m (in increments of 1000mm)
- External power supply (remote driver)

OPTIONS & ACCESSORIES

- Also available as IP65 as special request (specs will differ)
- Dimmable - Dali, 1-10v, DMX

MOUNTING

Surface / Suspended with Suspension Kits

APPLICATION AREAS

Indoor, Commercial, Retail, Hospitality

TECHNICAL DATA

GLF13E408031M

GLF13E408032M

LAMP	LED	LED
TOTAL POWER (W)	18W / 36W	36W / 72W
FACTOR	25% loss through lens	25% loss through lens
SOURCE OUTPUT (LM)	3000LM / 6000LM	6000LM / 12000LM
VOLTAGE	220-240V	220-240V
CCT (K)	4000K / 5000K	4000K / 5000K
BEAM ANGLE	110°	110°
CRI	85	85
POWER FACTOR	>0.95 *	>0.95 *
OPERATING TEMP °C	-30°C TO 55°C	-30°C TO 55°C

* subject to length and wattage

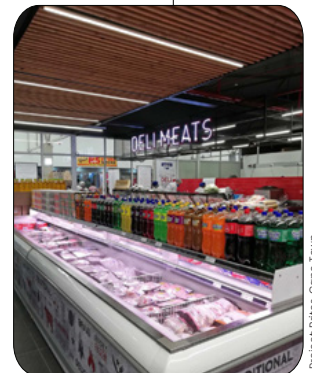

Project Britos, Capoe Town

- CD / KLM
- C0 - C180
 - C90 - C270

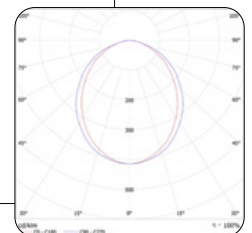

E&OE MAY OCCUR

SKYWALKER 1

**SURFACE/SUSPENDED
LINEAR LIGHTING**

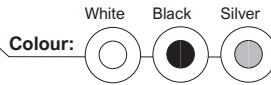
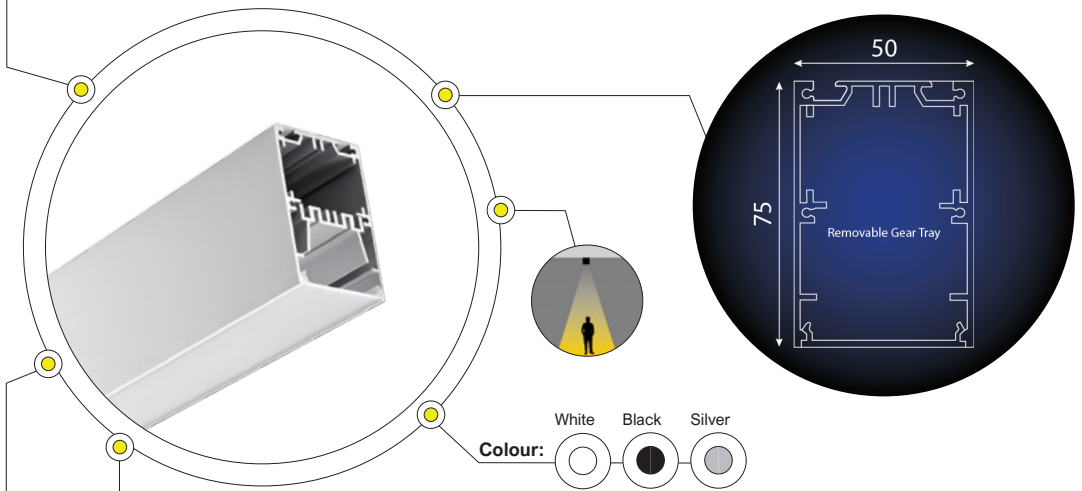

+IP
20



5 YRS

ldt

PHYSICAL DATA

FEATURES

- Aluminium extrusion with PMMA Opal diffuser
- Built-In LED Driver
- Maintenance by removable gear tray
- Customizable lengths and shapes

- Harvesting, Time Switch Control, Smart-light control and Bluetooth
- Push / DALI / 1-10V Dimmable

OPTIONS & ACCESSORIES

- EMG 1hr or EMG 3hr available
- Available options: Occupancy Control, Daylight

MOUNTING

Suspended, Surface, Track

APPLICATION AREAS

Indoor, Commercial, Residential, Retail, Hospitality

TECHNICAL DATA

LLEDSW1-3K

LLEDSW1-4K

LAMP	LED	LED
TOTAL POWER (W)	20 / 28 / 41W per m	20 / 28 / 41W per m
SYSTEM OUTPUT (LM)	3170LM - 6550LM	3170LM - 6550LM
EFFICACY (LM/W)	182 / 174 / 165	182 / 174 / 165
CCT (K)	3000K	4000K
CRI (Ra)	>80	>80
BEAM ANGLE	120°	120°
OPERATING VOLTAGE-VAC	230V 50Hz	230V 50Hz
SOURCE POWER(W)	22.5 - 46W per m	22.5 - 46W per m
SOURCE OUTPUT (LM)	3607 / 4490 / 6865LM	3805 / 5380 / 7322 LM
OPERATING TEMP °C	-20°C TO 45°C	-20°C TO 45°C
TC CASE MAX TEMP °C	70 - 90°C	70 - 90°C
CURRENT (MA)	250MA-500MA	250MA-500MA
RATED LIFE (HRS)	50 000HRS	50 000HRS
POWER FACTOR	0.95	0.95
LUMEN MAINTENANCE	L90-B10	L90-B10
FLICKER FACTOR	<5%	<5%
MAC ADAM STEP	3 SDCM	3 SDCM
DIMENSIONS	W:50 x H:75mm	W:50 x H:75mm



Project LGS Decating Stellenbosch University

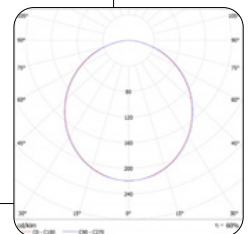

- CD / KLM
- C0 - C180
 - C90 - C270

E&OE MAY OCCUR

SKYWALKER 2

**SURFACE/SUSPENDED
LINEAR LIGHTING**

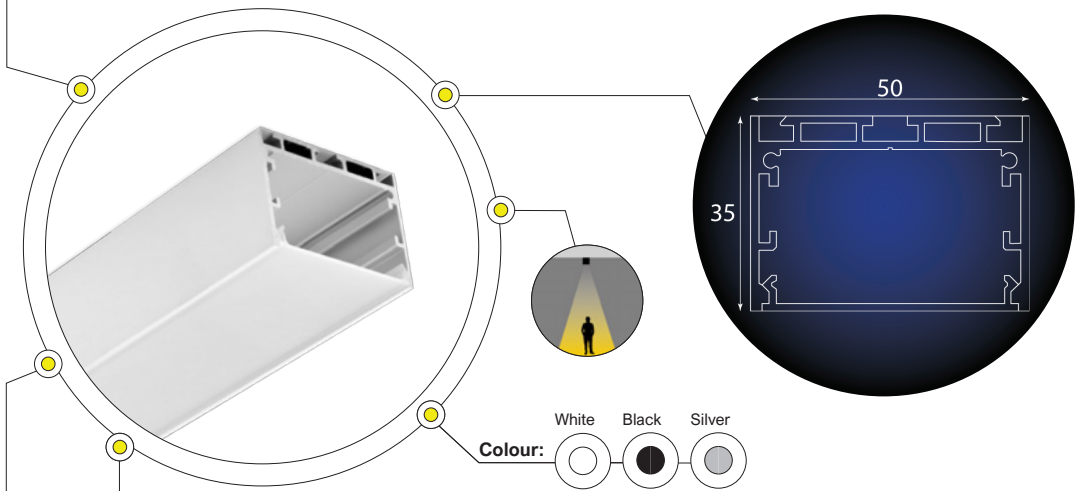

+ IP 20



3 YRS

ldt

PHYSICAL DATA

FEATURES

- Aluminium extrusion with clip-in PMMA Opal diffuser
- Drivers to be installed remotely
- Customizable lengths and shapes

- Push / DALI / 1-10V Dimmable

MOUNTING

Suspended or Surface

OPTIONS & ACCESSORIES

- EMG 1hr or EMG 3hr available
- Available options: Occupancy Control, Daylight Harvesting, Time Switch Control and Bluetooth

APPLICATION AREAS

Indoor, Commercial, Residential, Retail, Hospitality

TECHNICAL DATA

LLEDSW2-3K

LLEDSW2-4K

LAMP	LED	LED
TOTAL POWER (W)	20 / 28 / 41W per m	20 / 28 / 41W per m
SYSTEM OUTPUT (LM)	3607 / 4490 / 6865LM	3805 / 5280 / 7322LM
EFFICACY (LM/W)	182 / 174 / 165	192 / 186 / 176
CCT (K)	3000K	4000K
CRI (Ra)	>80	>80
BEAM ANGLE	120°	120°
OPERATING VOLTAGE-VAC	220-240V	220-240V
OPERATING TEMP °C	-20°C TO 35°C	-20°C TO 35°C
CURRENT (MA)	250 / 350 / 500MA	250 / 350 / 500MA
RATED LIFE (HRS)	50 000HRS	50 000HRS
POWER FACTOR	0.95	0.95
LUMEN MAINTENANCE	L90-B10	L90-B10
FLICKER FACTOR	<5%	<5%
MAC ADAM STEP	3 SDCM	3 SDCM
DIMENSIONS	W:50 x H:35mm	W:50 x H:35mm

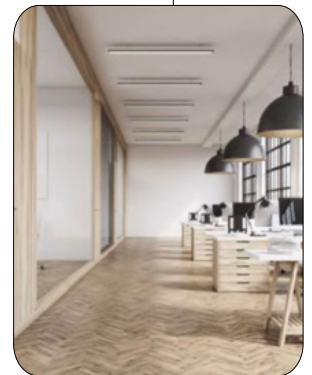

- CD / KLM
- C0 - C180
 - C90 - C270

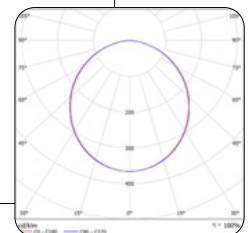

E&OE MAY OCCUR

SKYWALKER 3

**SURFACE/SUSPENDED
LINEAR LIGHTING**

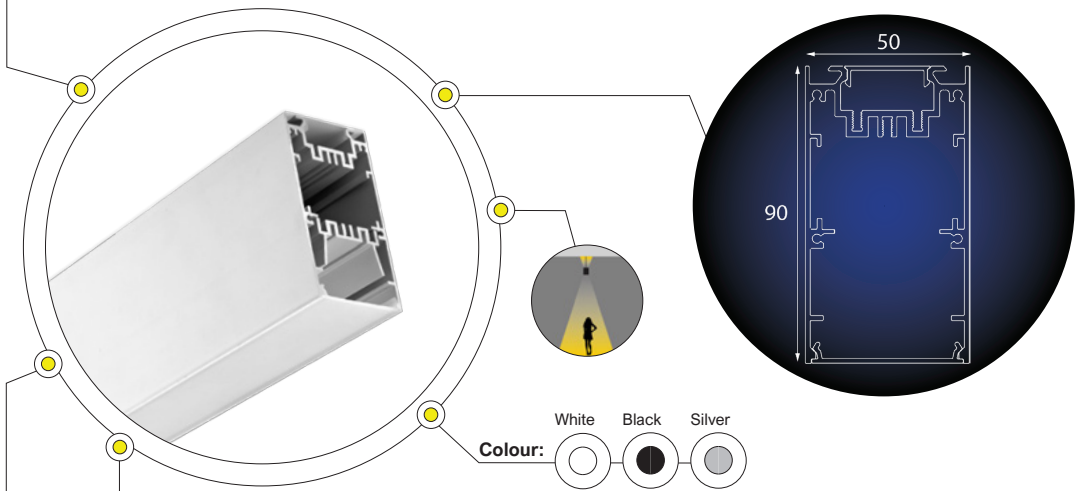

+ IP 20



5 YRS

ldt

PHYSICAL DATA

FEATURES

- Material: Aluminium extrusion with opal UV stabilized clip-in PMMA diffuser
- Innovative thermal management employing passive cooling
- Impact protection class IK8
- Maintenance by removable gear tray
- Built-in LED driver
- Customized lengths and shapes

OPTIONS & ACCESSORIES

- EMG 1hr or EMG 3hr available
- Available options: Occupancy Control, Daylight Harvesting, Time Switch Control and Bluetooth
- Push / DALI / 1-10V Dimmable

MOUNTING: Suspended or Wall Mount

APPLICATION AREAS: Indoor, Commercial, Residential, Retail, Hospitality

TECHNICAL DATA

LLEDSW3

LAMP	LED
TOTAL POWER (W)	20 / 28 / 41W per m
SYSTEM OUTPUT (LM)	3607 / 4490 / 6865LM
EFFICACY (LM/W)	182 / 174 / 165
CCT (K)	3000K
CRI (Ra)	>80
BEAM ANGLE	120°
OPERATING VOLTAGE-VAC	220-240V
OPERATING TEMP °C	-20°C TO 35°C
CURRENT (MA)	250 / 350 / 500MA
RATED LIFE (HRS)	50 000HRS
POWER FACTOR	0.95
LUMEN MAINTENANCE	L90-B10
FLICKER FACTOR	<5%
MAC ADAM STEP	3 SDCM
DIMENSIONS	W:50 x H:90mm



- CD / KLM
- C0 - C180
 - C90 - C270

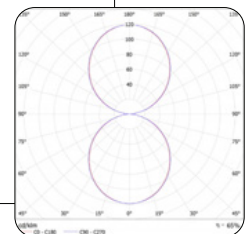

E&OE MAY OCCUR

SKYWALKER 8

**SURFACE/SUSPENDED
LINEAR LIGHTING**

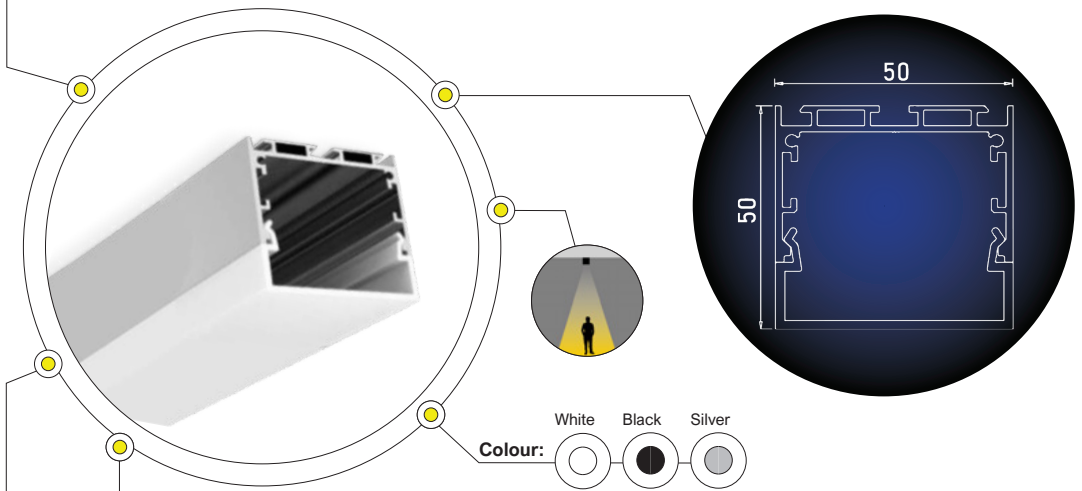

+ IP
20



✓
5 YRS

ldt

PHYSICAL DATA

FEATURES

- Material: Aluminium extrusion with opal UV stabilized clip-in PMMA diffuser
- Impact protection class IK8
- LED driver required
- Customized lengths and shapes

- Available options: Occupancy Control, Daylight Harvesting, Time Switch Control and Bluetooth
- Push / DALI / 1-10V Dimmable

MOUNTING

Suspended, Surface

OPTIONS & ACCESSORIES

- EMG 1hr or EMG 3hr available

APPLICATION AREAS

Indoor, Commercial, Residential, Retail, Hospitality

TECHNICAL DATA

LLED5W8

LAMP	LED
TOTAL POWER (W)	20 / 28 / 41W per m
SYSTEM OUTPUT (LM)	3607 / 4490 / 6865LM @3000K 3805 / 5280 / 7322LM @4000K
EFFICACY (LM/W)	182 / 174 / 165 @3000K 192 / 186 / 176 @4000K
CCT (K)	3000K / 4000K
CRI (Ra)	>80
BEAM ANGLE	120°
OPERATING VOLTAGE-VAC	220-240V
OPERATING TEMP °C	-20°C TO 35°C
CURRENT (MA)	250 / 350 / 500MA
RATED LIFE (HRS)	50 000HRS
POWER FACTOR	0.95
LUMEN MAINTENANCE	L90-B10
FLICKER FACTOR	<5%
MAC ADAM STEP	3 SDCM
DIMENSIONS	W:50 x H:50mm



Project Star South / Photography, Archigraphy

- CD / KLM
- C0 - C180
 - C90 - C270

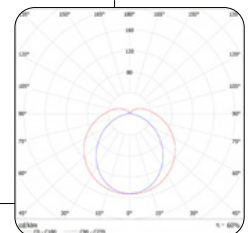

E&OE MAY OCCUR

SKYWALKER 4

RECESSED LINEAR LIGHTING

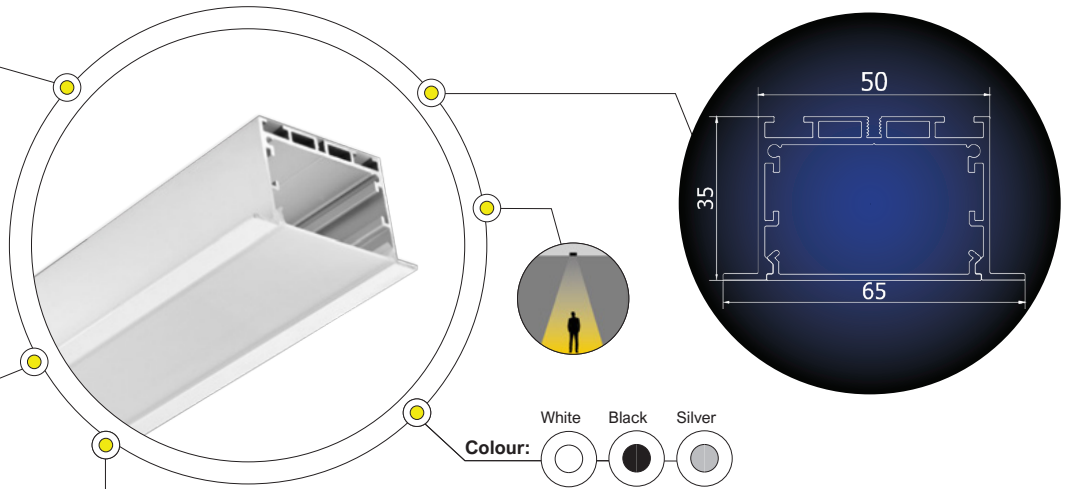

+ IP 20



5 YRS

ldt

PHYSICAL DATA

FEATURES

- Material: Aluminium extrusion with opal UV stabilized clip-in PMMA diffuser
- Innovative thermal management employing passive cooling
- Impact protection class IK8
- Driver to be installed remotely
- Customized lengths and shapes

- EMG 1hr or EMG 3hr available
- Available options: Occupancy Control, Daylight Harvesting, Time Switch Control and Bluetooth
- Push / DALI / 1-10V Dimmable

MOUNTING: Recessed

APPLICATION AREAS: Indoor, Commercial, Residential, Retail, Hospitality

OPTIONS & ACCESSORIES

TECHNICAL DATA

LLED5W4

LAMP	LED
TOTAL POWER (W)	20 / 28 / 41W per m
SYSTEM OUTPUT (LM)	3607 / 4490 / 6865LM @3000K 3805 / 5280 / 7322LM @4000K
EFFICACY (LM/W)	182 / 174 / 165 @3000K 192 / 186 / 176 @4000K
CCT (K)	3000K / 4000K
CRI (Ra)	>80
BEAM ANGLE	120°
OPERATING VOLTAGE-VAC	220-240V
OPERATING TEMP °C	-20°C TO 35°C
CURRENT (MA)	250 / 350 / 500MA
RATED LIFE (HRS)	50 000HRS
POWER FACTOR	0.95
LUMEN MAINTENANCE	L90-B10
FLICKER FACTOR	<5%
MAC ADAM STEP	3 SDCM
DIMENSIONS	W:65 x H:35mm



Project: SABBI

- CD / KLM
- C0 - C180
 - C90 - C270

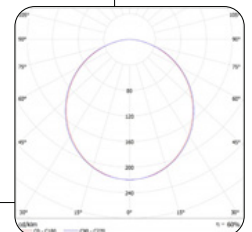

E&OE MAY OCCUR

SKYWALKER 5

RECESSED LINEAR LIGHTING

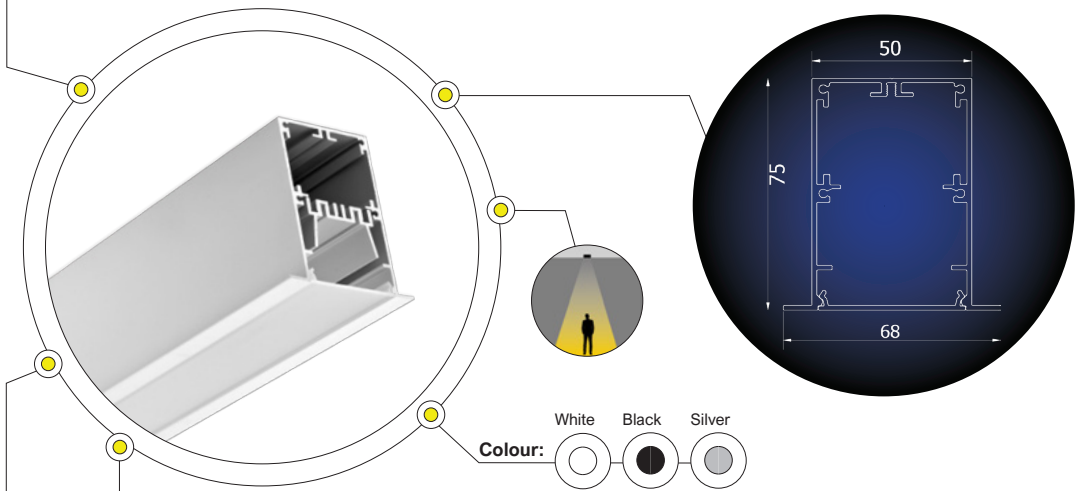

+ IP 20



5 YRS

ldt

PHYSICAL DATA

FEATURES

- Material: Aluminium extrusion with opal UV stabilized clip-in PMMA diffuser
- Innovative thermal management employing passive cooling
- Impact protection class IK8
- Maintenance by removable gear tray
- Built-in LED driver
- Customized lengths and shapes

OPTIONS & ACCESSORIES

- EMG 1hr or EMG 3hr available
- Available options: Occupancy Control, Daylight Harvesting, Time Switch Control and Bluetooth
- Push / DALI / 1-10V Dimmable

MOUNTING: Recessed

APPLICATION AREAS: Indoor, Commercial, Residential, Retail, Hospitality

TECHNICAL DATA

LLED5W5

LAMP	LED
TOTAL POWER (W)	20 / 28 / 41W per m
SYSTEM OUTPUT (LM)	3607 / 4490 / 6865LM @3000K 3805 / 5280 / 7322LM @4000K
EFFICACY (LM/W)	182 / 174 / 165 @3000K 192 / 186 / 176 @4000K
CCT (K)	3000K / 4000K
CRI (Ra)	>80
BEAM ANGLE	120°
OPERATING VOLTAGE-VAC	220-240V
OPERATING TEMP °C	-20°C TO 35°C
CURRENT (MA)	250 / 350 / 500MA
RATED LIFE (HRS)	50 000HRS
POWER FACTOR	0.95
LUMEN MAINTENANCE	L90-B10
FLICKER FACTOR	<5%
MAC ADAM STEP	3 SDCM
DIMENSIONS	W:68 x H:75mm



Project SABBI

- CD / KLM
- C0 - C180
 - C90 - C270

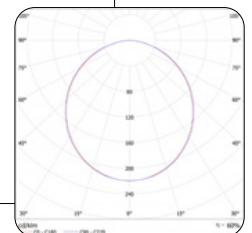

E&OE MAY OCCUR

➤ LINEAR RETAIL LIGHTING

COMMERCIAL & ARCHITECTURAL

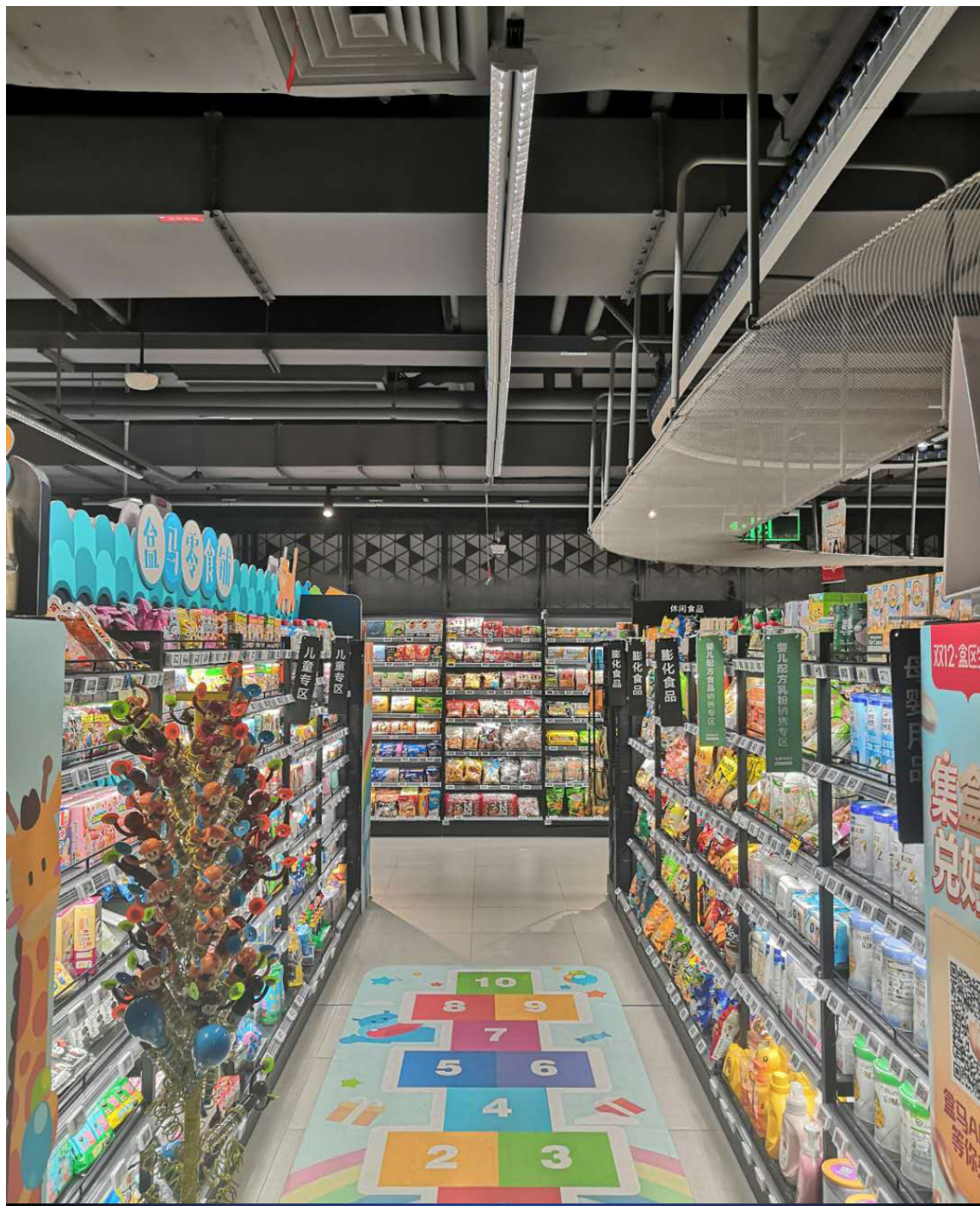

AISLE LIGHT

LINEAR RETAIL LIGHTING

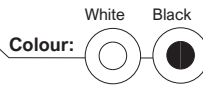
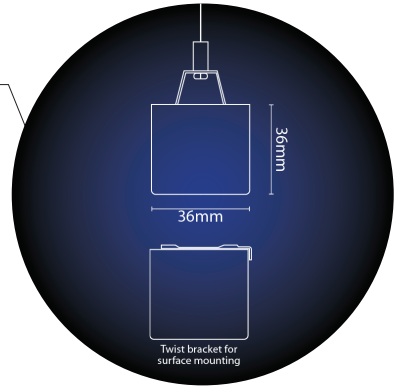
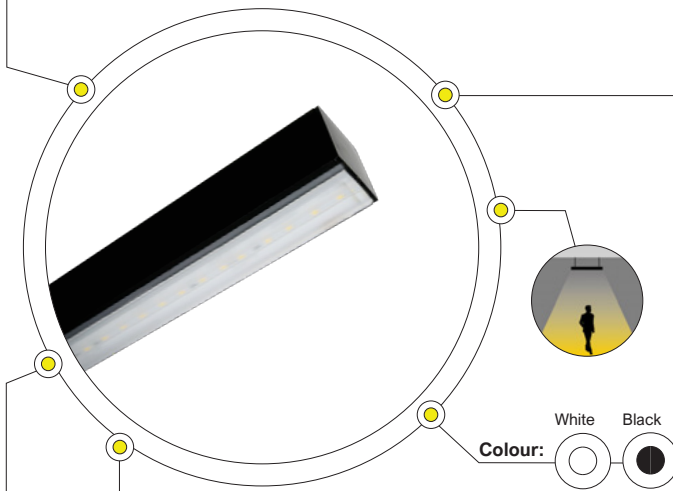

- + IP 20**
-
- 5 YRS**
- ldt**

PHYSICAL DATA

FEATURES

- Material: Extruded aluminium; either anodized or powder coated
- Bracket with surface mount with 'shadow line'
- Twist lock bracket for surface mounting
- Pieces can be joined to make longer runs up to 5m (in increments of 1150mm)
- Internal power supply

OPTIONS & ACCESSORIES

- Dimmable - Dali, 1-10v, DMX
- Also available as IP65 as special request (specs will differ)

MOUNTING: Surface / Suspended with Suspension Kits

APPLICATION AREAS

Indoor, Commercial, Retail

TECHNICAL DATA

GLF56408031.15M

GLF56408032.3M

LAMP	LED	LED
TOTAL POWER (W)	54W	108W
SOURCE OUTPUT (LM)	8944 LM	17 888 LM
VOLTAGE	220-240V	220-240V
CCT (K)	4000K / 5000K	4000K / 5000K
BEAM ANGLE	NARROW	NARROW
	WIDE	WIDE
	BATWING	BATWING
CRI	85	85
POWER FACTOR	>0.95 *	>0.95 *
OPERATING TEMP °C	-30°C TO 55°C	-30°C TO 55°C
LENGTH	1150mm	2300mm

* subject to length and wattage



Project Britos, Coppe Town

- CD / KLM
- C0 - C180
 - C90 - C270

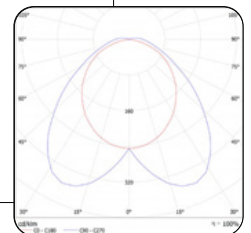

E&OE MAY OCCUR

LLEDSW9

LINEAR RETAIL LIGHTING

COMMERCIAL - LINEAR RETAIL LIGHTING - LLEDSW9

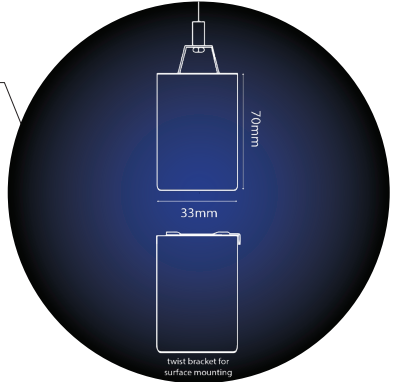
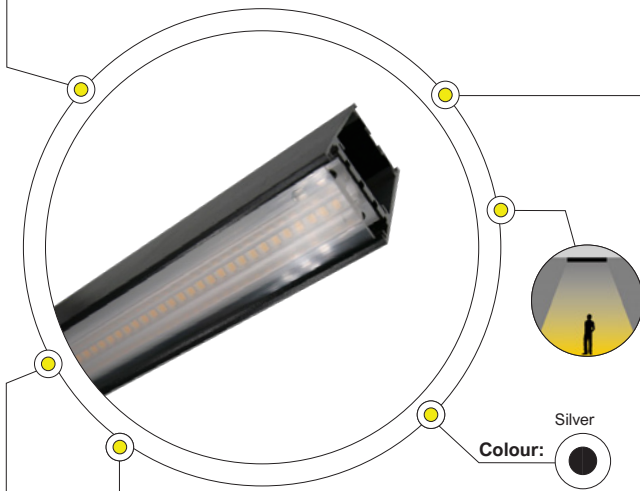

-  + IP 20
- 
-  LOA
-  5 YRS
-  Idt

PHYSICAL DATA

FEATURES

- Material: Aluminium
- Minimalist design
- Stable structure
- Good thermal dissipation
- High efficacy
- Continuous combination available
- Connector plates are included
- Cable tray mounted

OPTIONS & ACCESSORIES

- Suspension kit
- L1 connector
- Connector plate

MOUNTING

Suspended or Surface

APPLICATION AREAS

Indoor, Commercial, Retail

TECHNICAL DATA

LLEDSW9

LAMP	LED
TOTAL POWER (W)	60W
SYSTEM OUTPUT (LM)	9000LM
EFFICACY (LM/W)	150
CCT (K)	4000K
CRI (Ra)	>80
BEAM ANGLE	75° / 90°
OPERATING VOLTAGE-VAC	220-240V
POWER FACTOR	0.9
DIMENSIONS	L:1480 x W:33 x H70mm



MOUNTING BRACKET

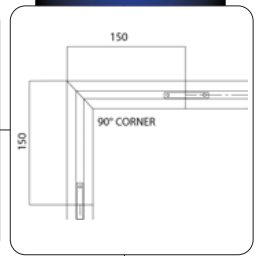

90° LIGHT CORNER



CD / KLM

-  C0 - C180
-  C90 - C270

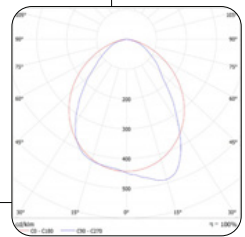

E&OE MAY OCCUR

XYRUS XX2 SINGLE

LINEAR RETAIL LIGHTING

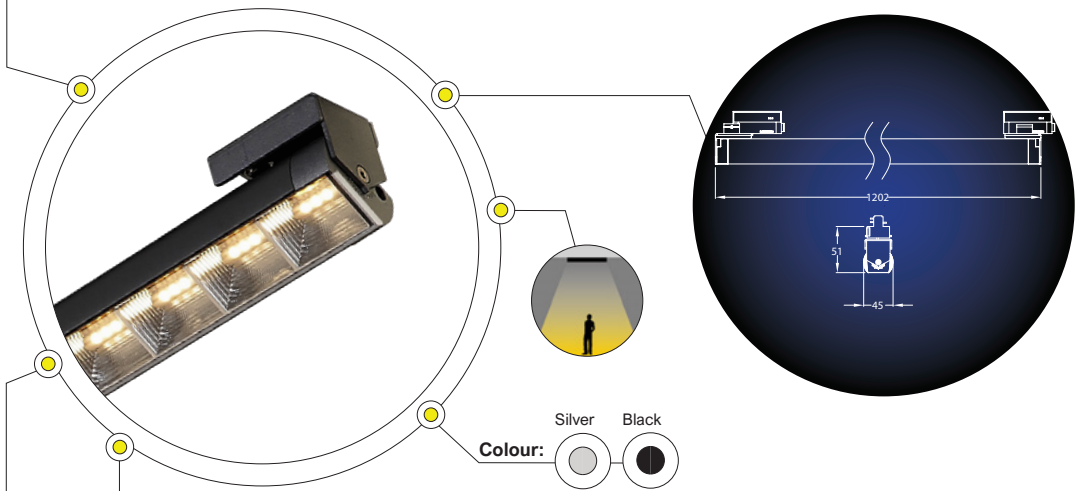

+ IP 20



LOA

5 YRS

ldt

PHYSICAL DATA

FEATURES

- Material: Die cast Aluminium body
- Versatile mounting options
- Adjustable, rotatable
- Low Flicker
- Anti-glare

MOUNTING

Track / Surface

APPLICATION AREAS

Indoor, Commercial, Retail

TECHNICAL DATA

LBR0130409020

LAMP	LED
TOTAL POWER (W)	30W
SYSTEM OUTPUT (LM)	3150LM
EFFICACY (LM/W)	105
CCT (K)	4000K
CRI (Ra)	>80
BEAM ANGLE	30°
OPERATING VOLTAGE-VAC	220-240V
CURRENT (MA)	700MA
OPERATING TEMP °C	65°C
TC CASE MAX TEMP °C	85°C
RATED LIFE (HRS)	30 000HRS
POWER FACTOR	>0.95
ILLUM @1M (LUX)	6255LX
UGR	<19
FLICKER FACTOR	FLICKER FREE
MAC ADAM STEP	3 SDCM
DIMENSIONS	L:1202 X W:45 X H:51mm



- CD / KLM
- C0 - C180
 - C90 - C270

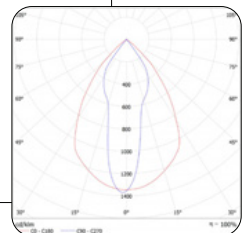

E&OE MAY OCCUR

XYRUS XX2 DOUBLE

LINEAR RETAIL LIGHTING

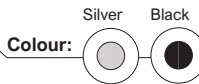
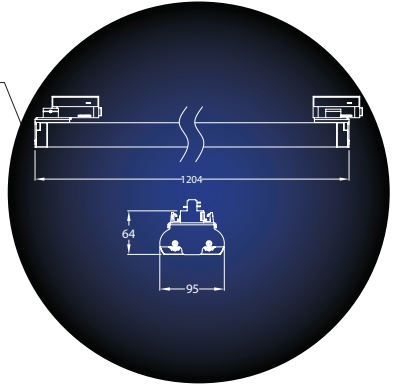
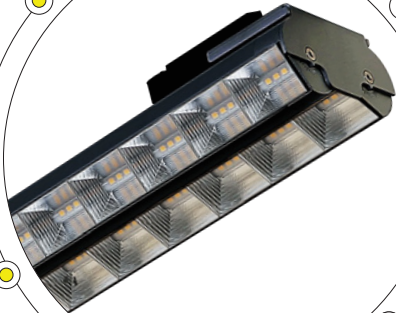

PHYSICAL DATA

FEATURES

- Material: Die cast Aluminium body
- Versatile mounting options
- Adjustable, rotatable
- Low Flicker
- Anti-glare

MOUNTING

Track / Surface

APPLICATION AREAS

Indoor, Commercial, Retail

+ IP 20



LOA

5 YRS

ldt

TECHNICAL DATA

LBR01230409020

LAMP	LED
TOTAL POWER (W)	60W
SYSTEM OUTPUT (LM)	6300LM
EFFICACY (LM/W)	105
CCT (K)	4000K
CRI (Ra)	>80
BEAM ANGLE	45°
OPERATING VOLTAGE-VAC	220-240V
CURRENT (MA)	700MA
OPERATING TEMP °C	65°C
TC CASE MAX TEMP °C	85°C
RATED LIFE (HRS)	30 000HRS
POWER FACTOR	>0.95
ILLUM @1M (LUX)	6387LX
UGR	<23
FLICKER FACTOR	FLICKER FREE
MAC ADAM STEP	3 SDCM
DIMENSIONS	L:1204 X W:95 X H:64mm

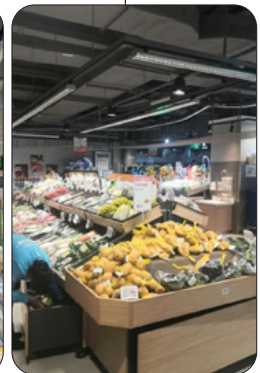
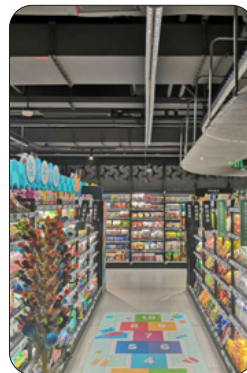

- CD / KLM
- C0 - C180
 - C90 - C270

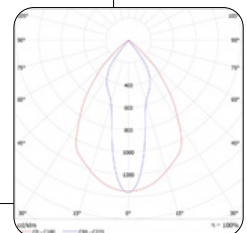

E&OE MAY OCCUR

> PENDANTS

COMMERCIAL

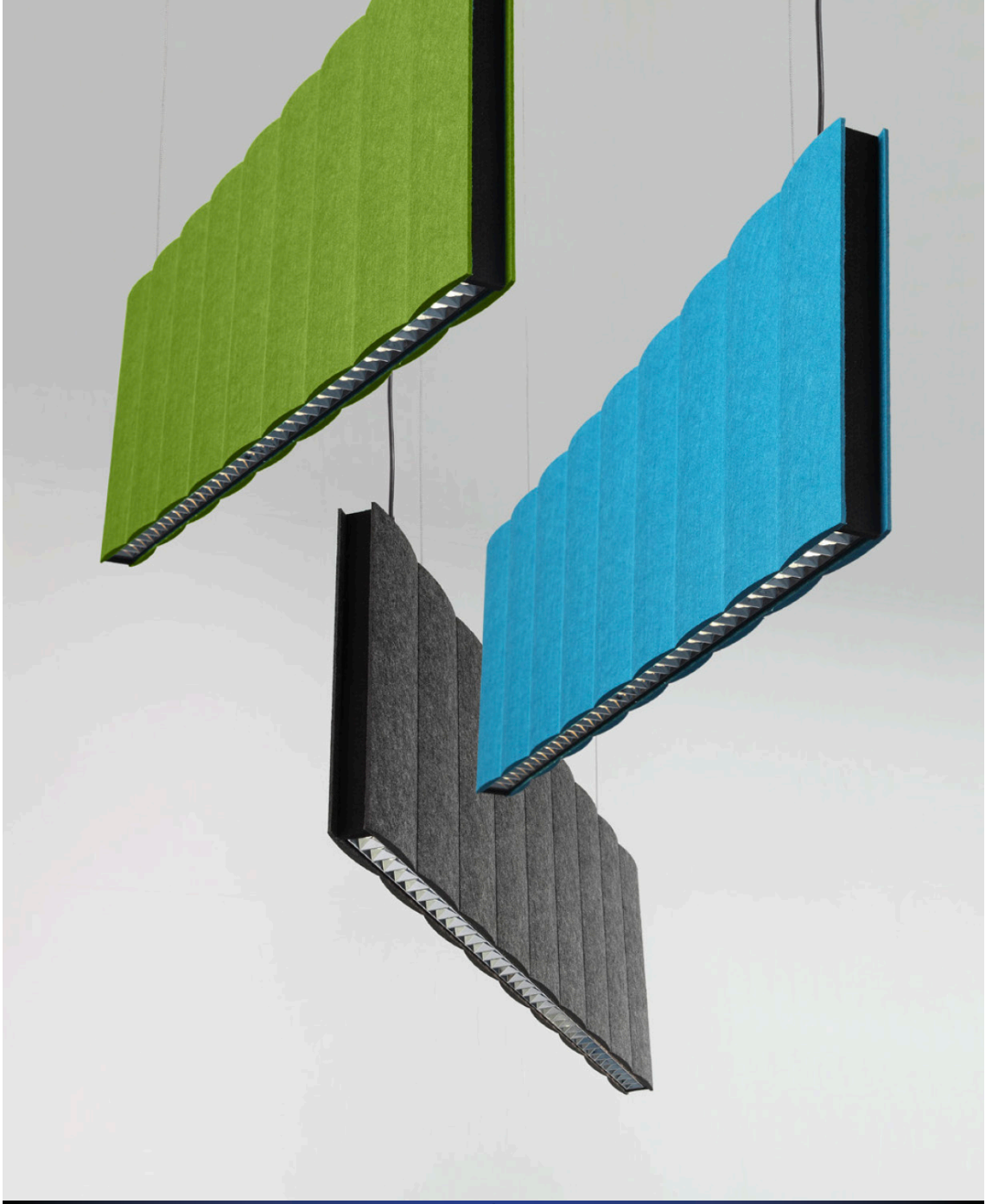

COLOR

PENDANTS

PENDANTS - COMMERCIAL - COLOR

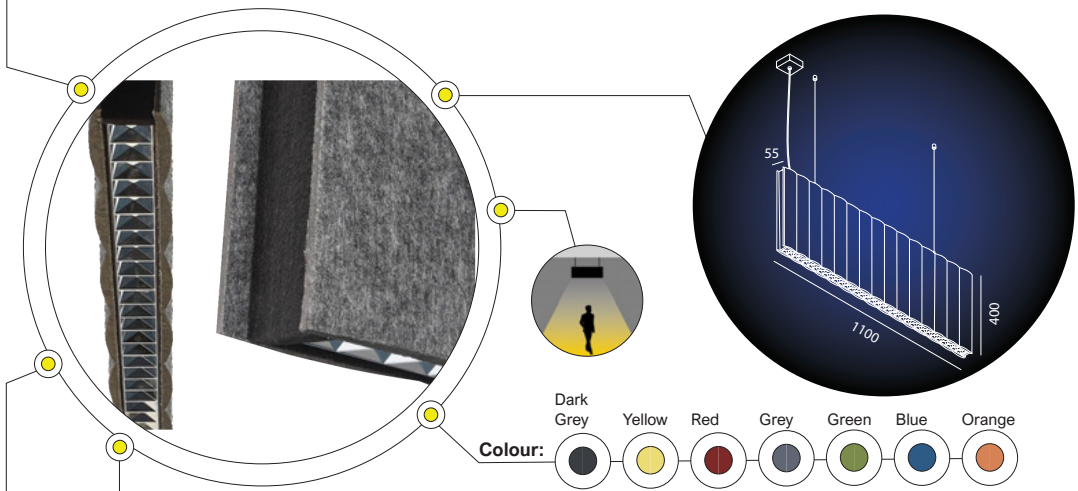

- + IP 20
-
-
-

PHYSICAL DATA

FEATURES

- Material: Aluminium alloy with acoustic polyester fibre covering
- The COLOR is made from sound-absorbing fabric that is flame retardant, non-toxic and non-irritating
- This scalloped acoustic-pendant has an excellent optical system made up of polarized light cups and an upper polarized lens
- This luminaire an excellent example of deep light control, the design of which reduces the UGR of the lamp and the overall glare to the eyes, making it ideal for the office environment

environment

OPTIONS & ACCESSORIES

- DALI, 1-10V dimming, light control, Bluetooth and adjustable colour temperature options available

MOUNTING: Suspended

APPLICATION AREAS: Indoor, Commercial, Residential, Retail, Hospitality, Libraries, Conference Areas

TECHNICAL DATA

PHPL05551SL

LAMP	LED
TOTAL POWER (W)	30W
SYSTEM OUTPUT (LM)	3097LM
EFFICACY (LM/W)	102.5
CCT (K)	3000 / 4000 / 6000K
CRI (Ra)	>80
BEAM ANGLE	40.3°
UGR	<18.0
OPERATING VOLTAGE-VAC	220-240V
FREQUENCY RANGE	50/60HZ
OPERATING TEMP °C	-25°C to 40°C
RATED LIFE (HRS)	30 000HRS
POWER FACTOR	0.932
DIMENSIONS	L:1100 x W:55 x H:400mm

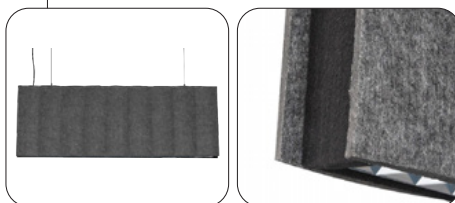

- CD / KLM
- C0 - C180
 - C90 - C270

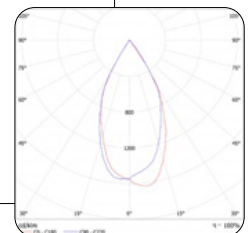

E&OE MAY OCCUR

HONEYCOMB

PENDANTS

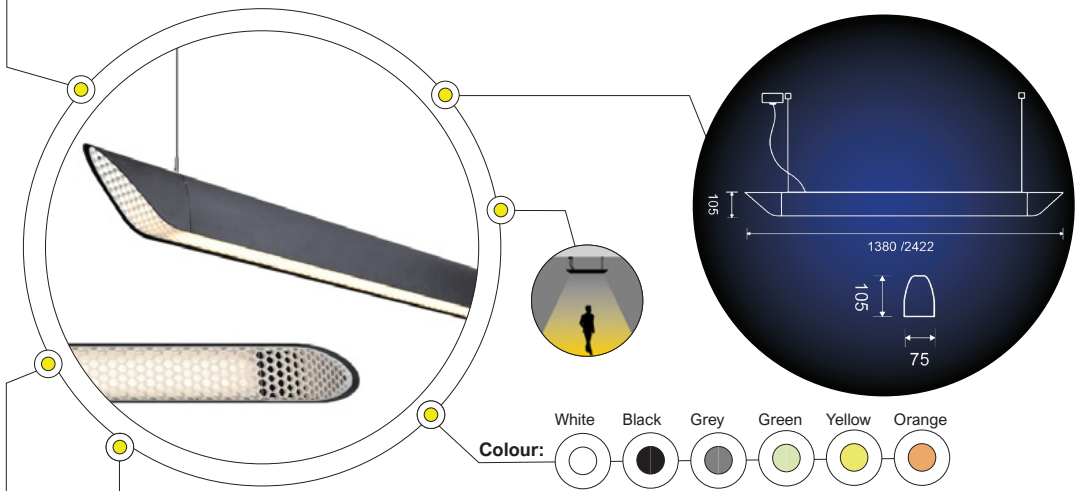

PHYSICAL DATA

FEATURES

- Material: Aluminium alloy body with die-cast ends and PMMA diffuser with polyester fibre fabric covering
- The HONEYCOMB is an acoustic pendant that has a unique curved design and this luminaire offering cellular light control
- The diffusing mask and the honeycomb anti-glare device curve across the lower curved surface of the luminaire
- This luminaire effectively reduces the UGR coefficient of the luminaire, reducing the damage of the light pollution to the human eye, and provides comfortable lighting for the office

OPTIONS & ACCESSORIES

- Available in standard 1380mm and 2422mm lengths
- Various power options available: 30W, 36W, 45W and 60W
- DALI, 1-10V dimming, light control and adjustable colour temperature options are available

MOUNTING

Suspended

APPLICATION AREAS: Indoor, Commercial, Residential, Retail, Hospitality, Libraries, Conference Areas

TECHNICAL DATA

PHHC07541SLC

LAMP	LED
TOTAL POWER (W)	36W
SYSTEM OUTPUT (LM)	2008LM
EFFICACY (LM/W)	51.1
CCT (K)	3000 / 4000 / 6000K
CRI (Ra)	>80
BEAM ANGLE	72.8°
UGR	18.0
OPERATING VOLTAGE-VAC	220-240V
FREQUENCY RANGE	50/60HZ
OPERATING TEMP °C	-20°C to 40°C
RATED LIFE (HRS)	30 000HRS
POWER FACTOR	0.951
WEIGHT (KG)	3.7KG
DIMENSIONS	W:75 x H:105 x L:1380mm



- CD / KLM
- C0 - C180
 - C90 - C270

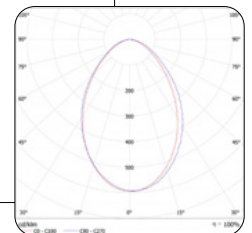

E&OE MAY OCCUR

LP01

PENDANTS

PENDANTS - COMMERCIAL - LP01

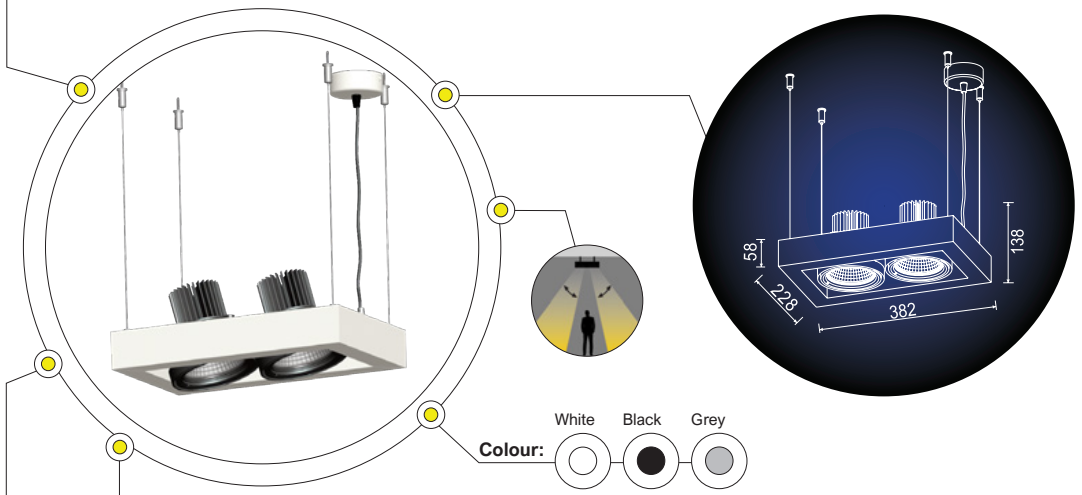

- + IP 20
-
- LOA
- 5 YRS
- ldt
- F
-

PHYSICAL DATA

FEATURES

- Material: Aluminium
- Higher reflective efficiency with the ALANOD MIRO material

MOUNTING

Suspended

OPTIONS & ACCESSORIES

- Special CCT options available for the lighting of meat, bread, fish, vegetables and clothing
- Glass accessory available

APPLICATION AREAS

Indoor, Commercial, Retail, Hospitality

TECHNICAL DATA

LP01225

LAMP	LED
TOTAL POWER (W)	2 x 25W
SYSTEM OUTPUT (LM)	2940 / 2970LM (x2)
EFFICACY (LM/W)	99
CCT (K)	3500 / 4000K
CRI (Ra)	80
BEAM ANGLE	15° / 24° / 44° / 59°
RATED LIFE (HRS)	50 000 HRS
OPERATING VOLTAGE-VAC	220-240V
CURRENT (mA)	700mA (x2)
SOURCE POWER (W)	30W (x2)
SOURCE OUTPUT (LM)	3417 / 3426LM (x2)
ILLUM @ 1M (LUX)	21863 / 15892LX (x2)
FLICKER FACTOR	<4%
OPERATING TEMP °C	-20°C TO 50°C
POWER FACTOR	≥0.9
R9 VALUE	12
UGR	<15
MAC ADAM STEP	3SDCM
DIMENSIONS	L:382 x W:228 x H:138mm

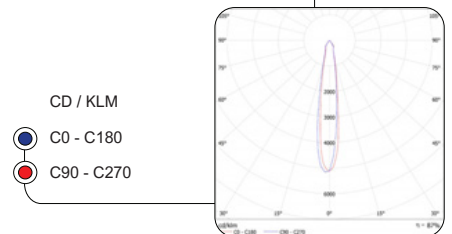

E&OE MAY OCCUR

LP05

PENDANTS

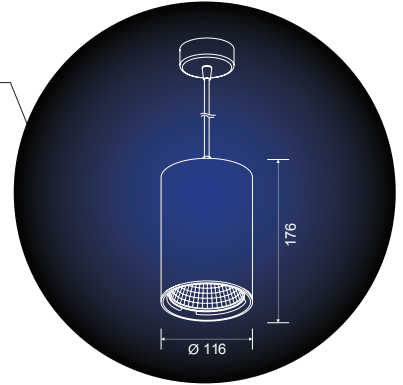
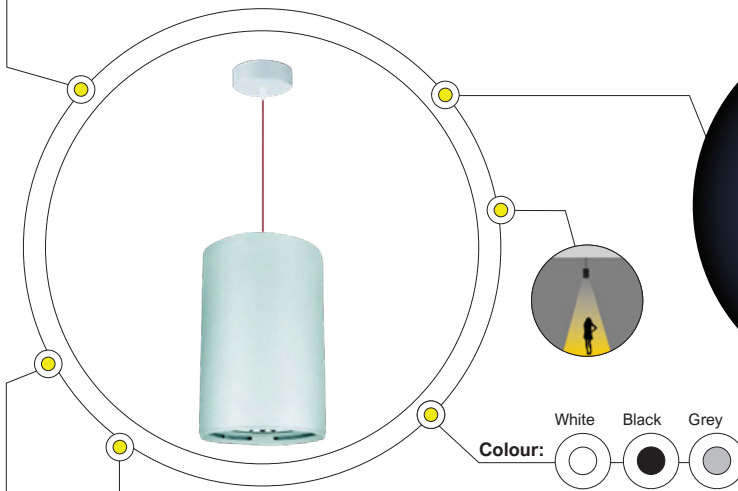

PHYSICAL DATA

FEATURES

- Material: Aluminium
- Better heat dissipation with higher density aluminium alloy
- Higher reflective efficiency with the Alanrod Miro material
- High quality LEDs to ensure excellent chromatic yield for strict colour rendering

- Special CCT options available for the lighting of meat, bread, fish, vegetables and clothing
- Glass accessories available
- Track version available

OPTIONS & ACCESSORIES

- TRIAC, 0-10V, Dali dimming options available
- CRI93 and 97 options available

MOUNTING

Suspended

APPLICATION AREAS

Indoor, Commercial, Residential, Retail, Hospitality

TECHNICAL DATA

	LP0517	LP0525
LAMP	LED	LED
TOTAL POWER (W)	17W	25W
SYSTEM OUTPUT (LM)	2185 / 2245LM	2940 / 2970LM
EFFICACY (LM/W)	105 / 108	99 / 99
CCT (K)	3500 / 4000K	3500 / 4000K
CRI (Ra)	80	80
BEAM ANGLE	15° / 24° / 44° / 59°	15° / 24° / 44° / 59°
RATED LIFE (HRS)	50 000 HRS	50 000 HRS
OPERATING VOLTAGE-VAC	220-240V	220-240V
CURRENT (MA)	500MA	700MA
SOURCE POWER (W)	20W	30W
SOURCE OUTPUT (LM)	2448 / 2479LM	3417 / 3426LM
ILLUM @ 1M (LUX)	15644 / 11743LX	21863 / 15892LX
FLICKER FACTOR	<4%	<4%
OPERATING TEMP °C	-20°C TO 50°C	-20°C TO 50°C
POWER FACTOR	≥0.9	≥0.9
R9 VALUE	11	12
UGR	<15	<15
MAC ADAM STEP	3SDCM	3SDCM
DIMENSIONS	D:φ116 x H:177mm	D:φ116 x H:177mm

- CD / KLM
- C0 - C180
 - C90 - C270

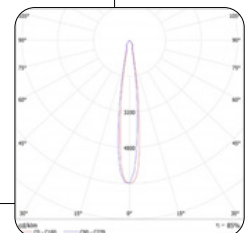

E&OE MAY OCCUR

LP06

PENDANTS

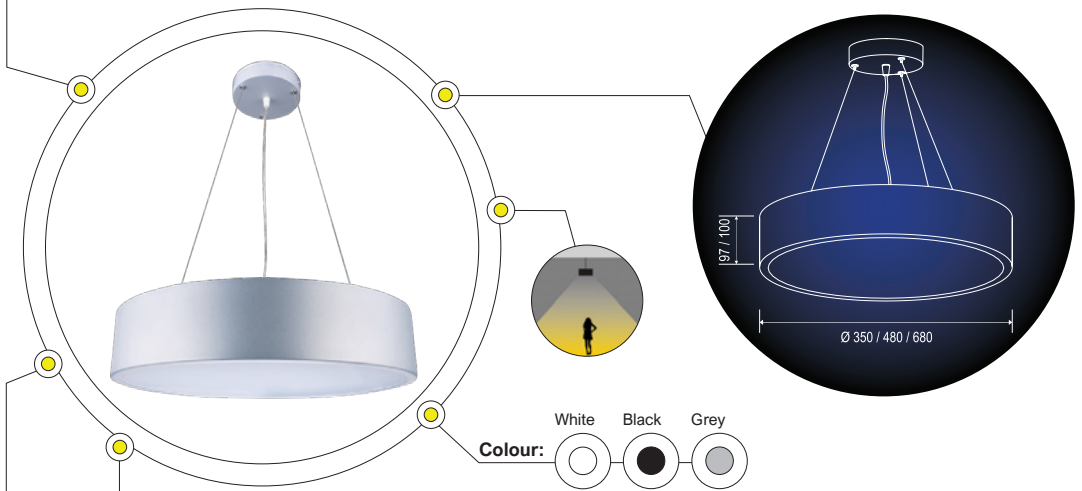

PHYSICAL DATA

FEATURES

- Material: Aluminium and polycarbonate

MOUNTING

Suspended

OPTIONS & ACCESSORIES

- TRIAC, 0-10V, Dali dimming options available
- Surface Mount, Recessed versions available

APPLICATION AREAS

Indoor, Commercial, Residential, Retail, Hospitality



TECHNICAL DATA

LP0632

LP0636

LP0672

	LP0632	LP0636	LP0672
LAMP	LED	LED	LED
TOTAL POWER (W)	31W	30W	60W
SYSTEM OUTPUT (LM)	3357 / 3368LM	3468 / 3529LM	7350 / 7577LM
EFFICACY (LM/W)	97 / 101	102 / 105	107 / 115
CCT (K)	3500 / 4000K	3500 / 4000K	3500 / 4000K
CRI (Ra)	80	80	80
BEAM ANGLE	108°	108°	112°
RATED LIFE (HRS)	50 000 HRS	50 000 HRS	50 000 HRS
OPERATING VOLTAGE-VAC	220-240V	220-240V	220-240V
CURRENT (MA)	700MA	700MA	1400MA
SOURCE OUTPUT (LM)	4225 / 4229LM	4359 / 4435LM	8150 / 8100LM
ILLUM @ 1M (LUX)	428 / 430LX	455 / 451LX	759 / 793LX
FLICKER FACTOR	<4%	<4%	<4%
OPERATING TEMP °C	-20°C TO 50°C	-20°C TO 50°C	-20°C TO 50°C
POWER FACTOR	≥0.9	≥0.9	≥0.9
R9 VALUE	11	11	17
UGR	<25	<25	<25
MAC ADAM STEP	3SDCM	3SDCM	3SDCM
DIMENSIONS	D:φ350 x H:97mm	D:φ480 x H:100mm	D:φ680 x H:100mm

> PENDANTS

ARCHITECTURAL

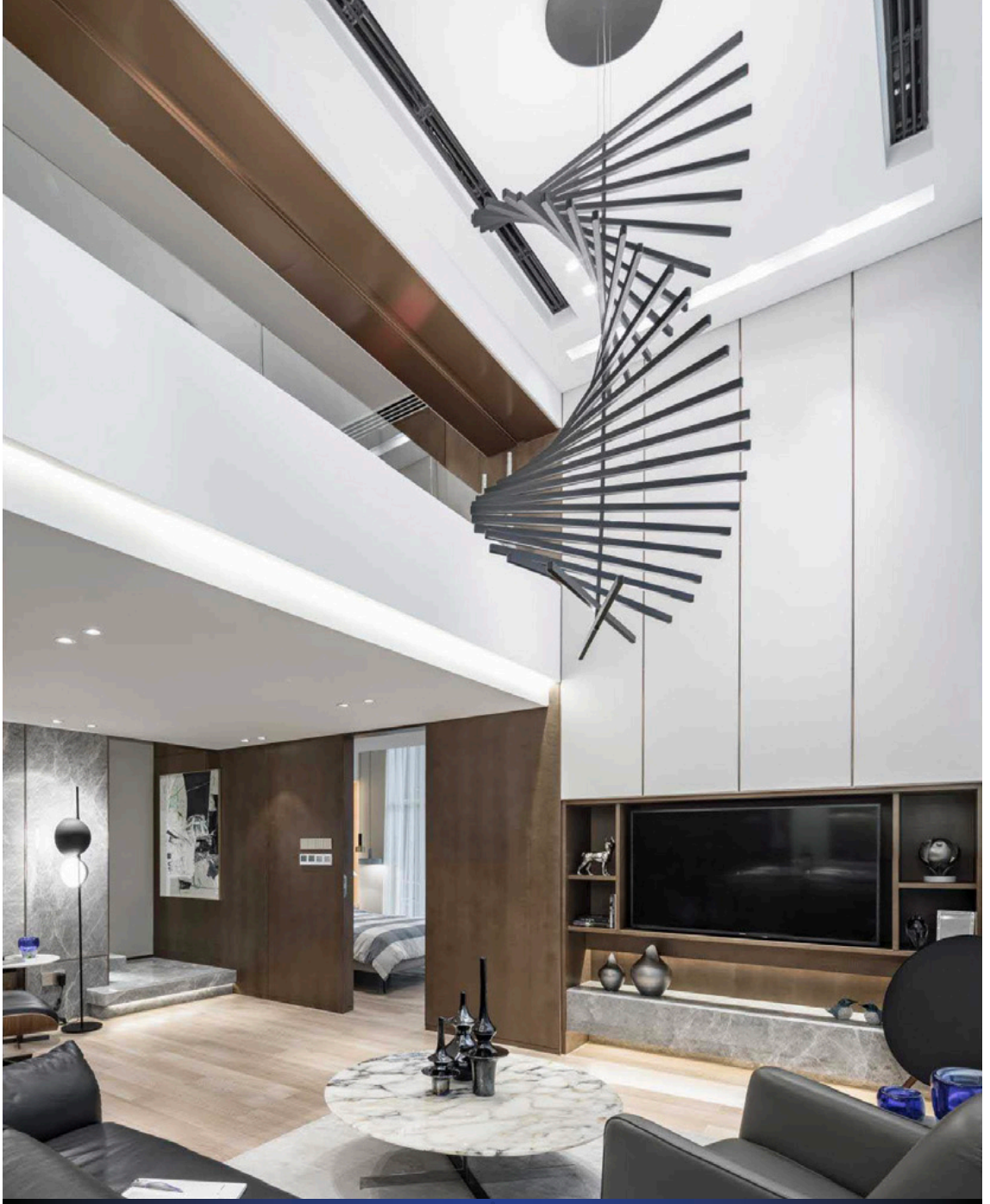

CLASSIC ROUND

PENDANTS

PENDANTS - ARCHITECTURAL - CLASSIC ROUND

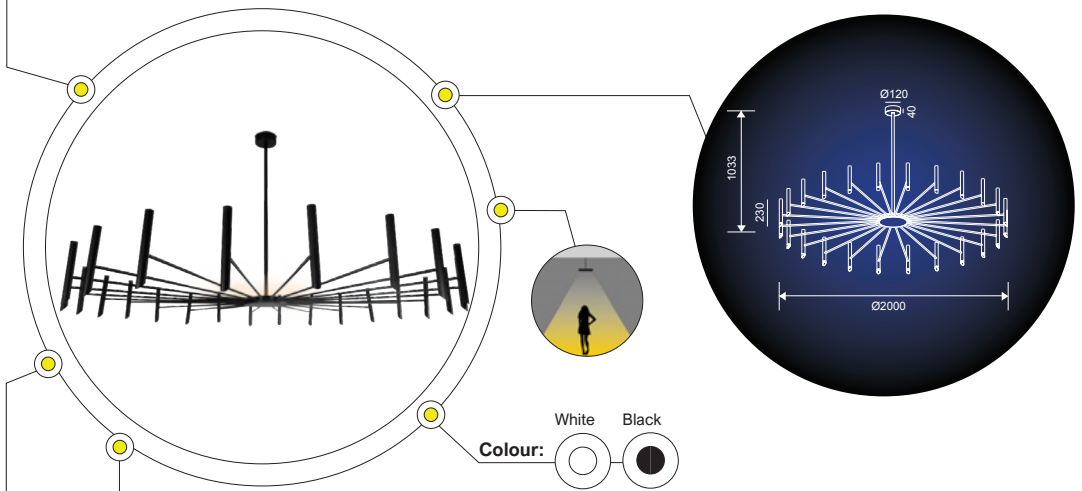

+ IP 20



LOA

3 YRS

PHYSICAL DATA

FEATURES

- Material: Aluminium
- The Classic is a dramatic conceptual chandelier that is a literal lighting sculpture
- Dimming 0/1-10V

MOUNTING

Suspended

APPLICATION AREAS

Indoor, Commercial, Residential, Retail, Hospitality

OPTIONS & ACCESSORIES

- Available in an ellipse version
- Extended height option available

TECHNICAL DATA

LF311517DXB

LAMP	LED
TOTAL POWER (W)	52.8W +10.5W
SYSTEM OUTPUT (LM)	3984LM
CCT (K)	3000K
CRI (Ra)	90
BEAM ANGLE	26°
OPERATING VOLTAGE-VAC	220-240V
SOURCE POWER (W)	53.76W + 11.43W
SOURCE OUTPUT (LM)	4776LM
DIMMING RANGE	10-100%
FLICKER FACTOR	101.69HZ / 0.65%
WEIGHT (KG)	10.3KG
DIMENSIONS	D:φ2000 x H: 1033mm

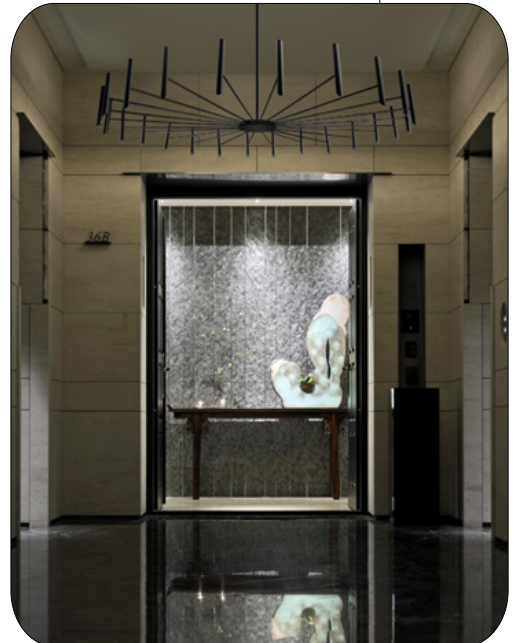

E&OE MAY OCCUR

CLASSIC ELLIPSE

PENDANTS

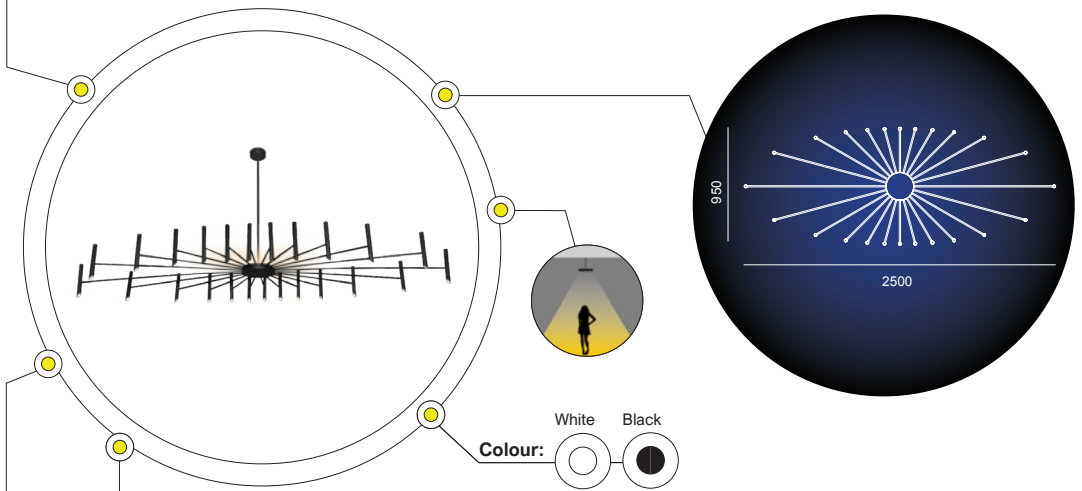

+ IP 20



LOA

3 YRS

PHYSICAL DATA

FEATURES

- Material: Aluminium
- A beautiful conceptual chandelier that is a testament to the inspired creative process and is the perfect choice as a statement piece
- Dimmable: Dim 0/1-10V

- Extended height options available

MOUNTING

Suspended

APPLICATION AREAS

Indoor, Commercial, Residential, Retail, Hospitality

OPTIONS & ACCESSORIES

- Round option available

TECHNICAL DATA

LF311617DX

LAMP	LED
TOTAL POWER (W)	52.8W + 10.5W
SYSTEM OUTPUT (LM)	3984LM
CCT (K)	3000K
CRI (Ra)	90
BEAM ANGLE	26°
OPERATING VOLTAGE-VAC	220-240V
SOURCE POWER (W)	53.76W + 11.43W
DIMMING RANGE	10-100%
FLICKER FACTOR	101.69Hz / 0.65%
WEIGHT (KG)	9KG
DIMENSIONS	L:2500 x W:950 x H:1033mm

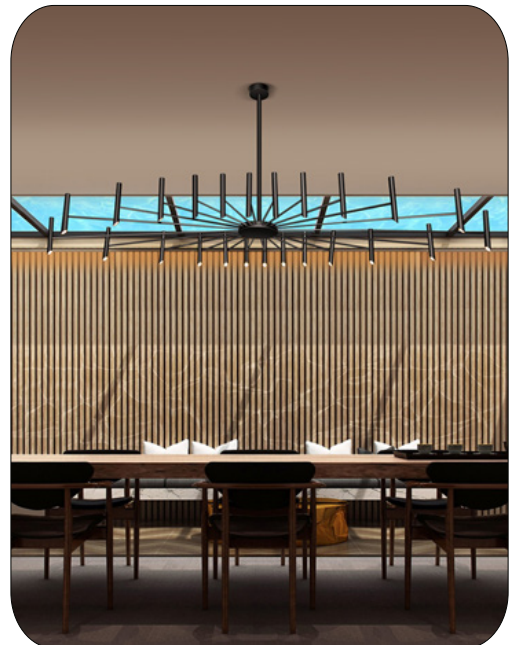

E&OE MAY OCCUR

FAIRY

PENDANTS

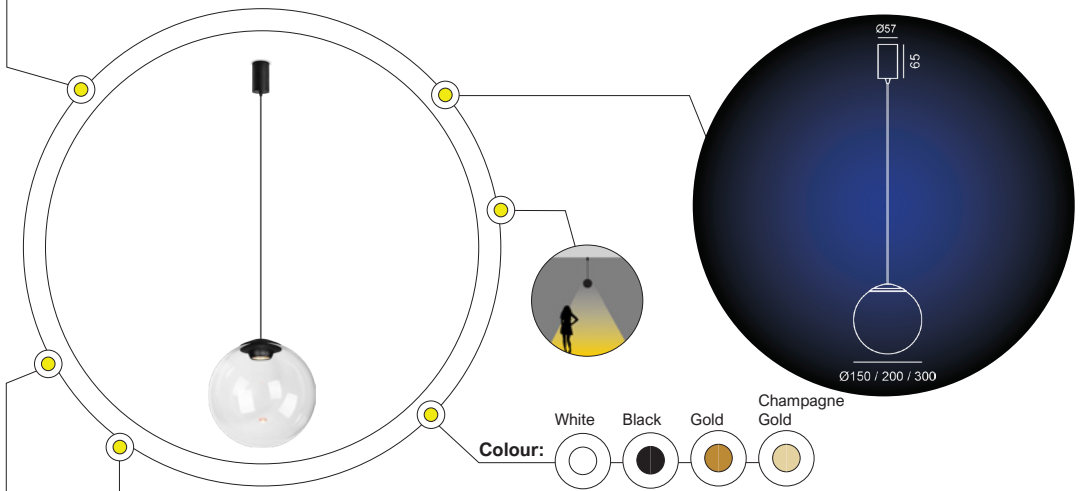

PHYSICAL DATA

FEATURES

- Material: Aluminium with glass globe
- Fairy is a transparent globe fixed on a long cord
- It's simple, pure design will give a beautiful effect in any space
- Low-glare shield and adjustable head makes it a versatile option

OPTIONS & ACCESSORIES

- Available in 3 diameters and different colours

MOUNTING

Suspended

APPLICATION AREAS

Indoor, Commercial, Residential, Retail, Hospitality

+ IP 20



LOA

3 YRS

ldt

TECHNICAL DATA

LF323919EA

LF326619EA

LF324019EA

LAMP	LED	LED	LED
TOTAL POWER (W)	3.8W	5.3W	9.5W
SYSTEM OUTPUT (LM)	170LM	409LM	738LM
CCT (K)	2700 / 3000 / 4000K	2700 / 3000 / 4000K	2700 / 3000 / 4000K
CRI (Ra)	90	90	90
BEAM ANGLE	36°	36°	36°
OPERATING VOLTAGE-VAC	100-240V	100-240V	100-240V
SOURCE POWER (W)	4.1W	6.5W	10.9W
SOURCE OUTPUT (LM)	384LM	649LM	1084LM
FLICKER FACTOR	107.5HZ / 0.73%	789.47HZ / 3.71%	101HZ / 2.15%
MOUNTING CUP	D:φ57 X H:65mm	D:φ57 X H:65mm	D:φ57 X H:65mm
GLOBE DIAMETER	φ150mm	φ200mm	φ300mm



- CD / KLM
- C0 - C180
 - C90 - C270

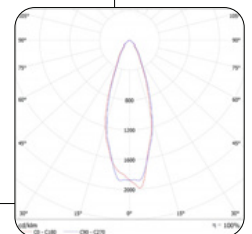

E&OE MAY OCCUR

FILOLUCE P2

PENDANT

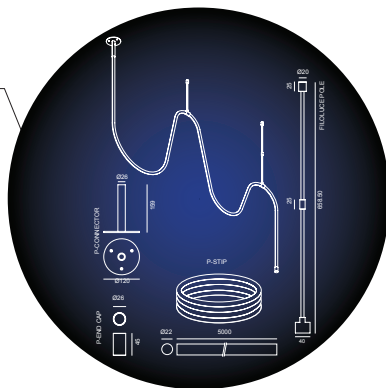
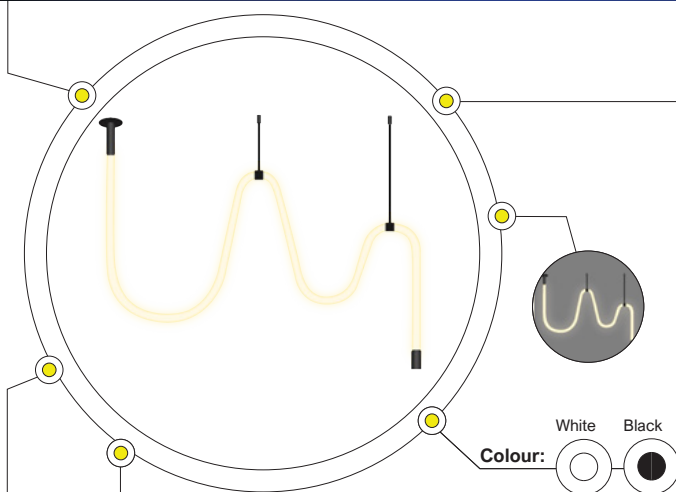

- + IP 20
- III
- 3 YRS
- F

PHYSICAL DATA

FEATURES

- Material: Steel and Silicone
- Driver: Turnable White - App
- The FILOLUCE is a unique art-piece, a true statement of modernity offers 360° diffused lighting
- The flexible tubular light is dimmed via a convenient APP and is voice APP supported
- Can be installed to create different shapes to suit various spaces using the accessories

OPTIONS & ACCESSORIES

- FILOLUCE W1 and W4 are wall mounted versions
- DALI, TRIAC and 1-10V dimming options available
- Additional mounting accessories available

MOUNTING: Surface, Ceiling

APPLICATION AREAS

Indoor, Commercial, Residential, Retail, Hospitality

TECHNICAL DATA

LF331819AP

LF331919AP

LAMP	LED	LED
TOTAL POWER (W)	86W	90W
CCT (K)	2700 - 4700K	RGB
CRI (Ra)	90	90
BEAM ANGLE	180°	180°
OPERATING VOLTAGE-VAC	24V / 48V	24V / 48V
DIMMING RANGE	15-100%	15-100%
DIMENSIONS		
TUBE	D:φ22 x L:5000mm	D:φ22 x L:5000mm
P-CONNECTOR	D:φ26 x L:150 x D:φ120mm	D:φ26 x L:150 x D:φ120mm
POLE	D:φ28 x L:658.5mm	D:φ28 x L:658.5mm
P-END CONNECTOR	D:φ26 x H:45mm	D:φ26 x H:45mm



E&OE MAY OCCUR

FILOLUCE P2

PENDANT



FILOLUCE P CONNECTOR
LF003063



FILOLUCE POLE
LF003065



FILOLUCE P END
LF003064



FILOLUCE STRIP RGB
LF003067

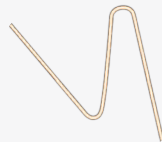

FILOLUCE STRIP W
LF003086

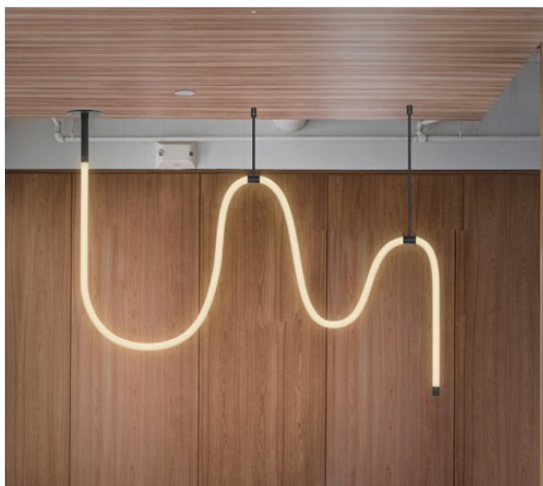
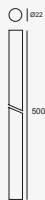
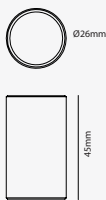
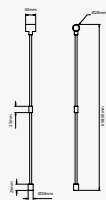
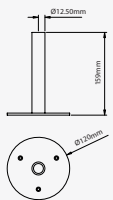

E&OE MAY OCCUR

FLASH M P SQ

PENDANTS

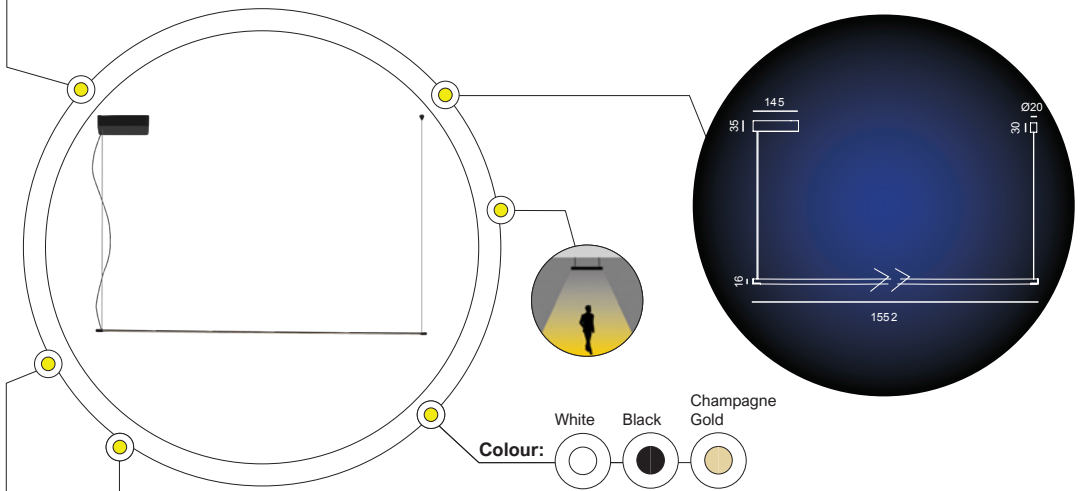

+ IP 20



LOA

3 YRS

PHYSICAL DATA

FEATURES

- Material: Aluminium
- This elegant and sophisticated fitting is an example of a clear artistic and creative vision
- Its ultra-thin frame looks phenomenal in any space
- TRIAC dimmable

OPTIONS & ACCESSORIES

- FLASH M V RO - Vertically suspended option available

- FLASH CK track option available for the ULTRA Track

MOUNTING

Suspended

APPLICATION AREAS

Indoor, Commercial, Residential, Retail, Hospitality, Galleries

TECHNICAL DATA

LF327419DT

LAMP	LED
TOTAL POWER (W)	31W
SYSTEM OUTPUT (LM)	1451LM
CCT (K)	3000 / 4000K
CRI (Ra)	90
BEAM ANGLE	180°
OPERATING VOLTAGE-VAC	220-240V
SOURCE POWER (W)	34W
SOURCE OUTPUT (LM)	3841LM
DIMMING RANGE	30-100%
FLICKER FACTOR	116HZ / 0.3%
WEIGHT (KG)	1.1KG
LUMINAIRE DIMENSIONS	L:1552 X H:16mm

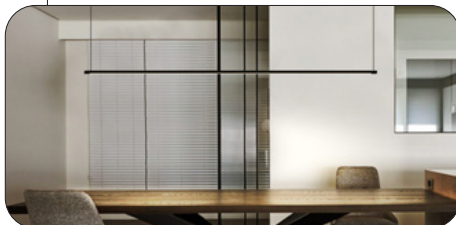

E&OE MAY OCCUR

FORMULIA P v2.1

PENDANTS

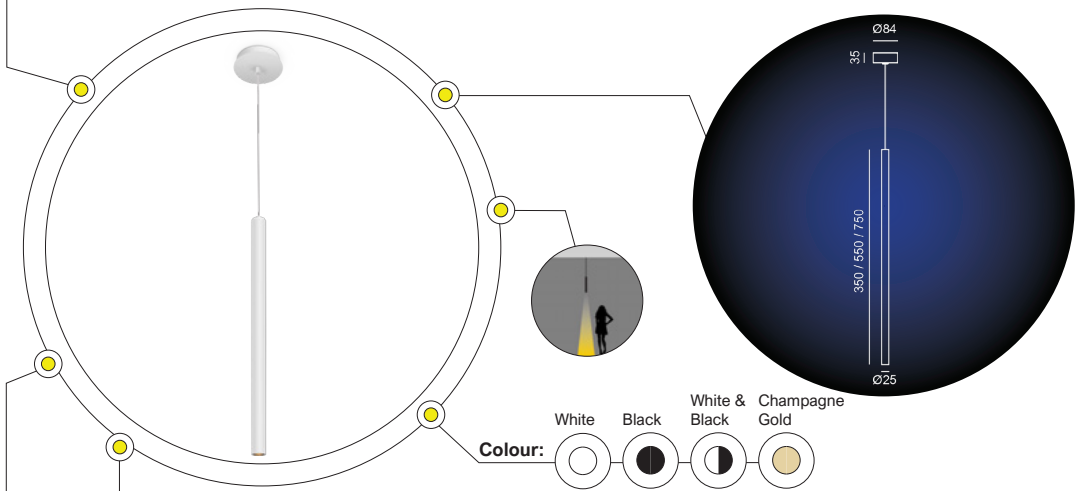

+ IP 20



LOA

3 YRS

ldt

PHYSICAL DATA

FEATURES

- Material: Aluminium
- The FORMULIA pendant embodies minimalism, elegance and functionality
- Suspend it's elegant slim tubes of different heights for visual drama and interest

750mm

- Mounting plate or trimless options available
- Chandelier and track option available in above lengths

MOUNTING

Suspended

OPTIONS & ACCESSORIES

- Available in three lengths: 350mm, 550mm and

APPLICATION AREAS

Indoor, Commercial, Residential, Retail, Hospitality

TECHNICAL DATA

LF326111A

LF326211A

LF326311A

LAMP	LED	LED	LED
TOTAL POWER (W)	7.1W	7.1W	7.1W
SYSTEM OUTPUT (LM)	446LM	446LM	446LM
CCT (K)	3000K	3000K	3000K
CRI (Ra)	90	90	90
BEAM ANGLE	19°	19°	19°
OPERATING VOLTAGE-VAC	100-240V	100-240V	100-240V
SOURCE POWER (W)	7.1W	7.1W	7.1W
SOURCE OUTPUT (LM)	660LM	660LM	660LM
FLICKER FACTOR	789.47HZ / 3.71%	789.47HZ / 3.71%	789.47HZ / 3.71%
WEIGHT (KG)	0.74KG	1.11KG	1.28KG
MOUNTING CUP	D:φ84 x H:35mm	D:φ84 x H:35mm	D:φ84 x H:35mm
DIMENSIONS	D:φ25 x H:350mm	D:φ25 x H:550mm	D:φ25 x H:750mm

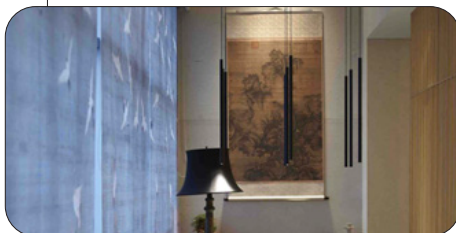

CD / KLM

● C0 - C180

● C90 - C270

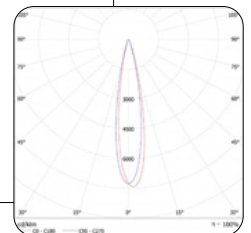

E&OE MAY OCCUR

FORMULIA L GROUP v2.0

PENDANTS

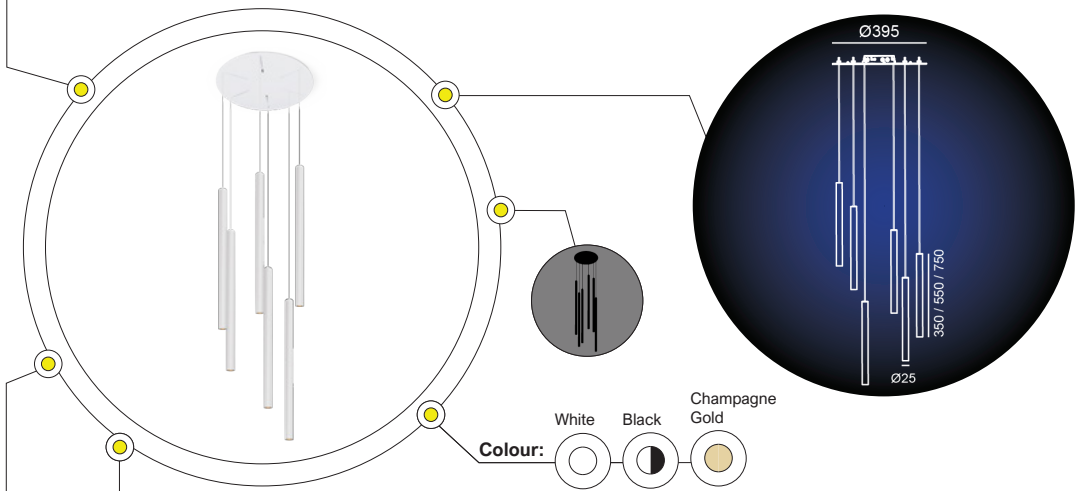

+ IP 20



LOA

3 YRS

ldt

PHYSICAL DATA

FEATURES

- Material: Aluminium
- The FORMULIA L chandelier embodies minimalism, elegance and functionality with its elegantly suspended slim tubes hung at different heights
- TRIAC Dimmable

750mm

- Singular tube pendants in the three sizes available

MOUNTING

Suspended

APPLICATION AREAS

Indoor, Commercial, Residential, Retail, Hospitality

OPTIONS & ACCESSORIES

- Three tube lengths available: 350mm, 550mm and

TECHNICAL DATA

LF321077DT

LF321177DT

LF321467DT

NAME	FORMULIA L 350 GROUP	FORMULIA L 550 GROUP	FORMULIA L 750 GROUP
LAMP	LED	LED	LED
TOTAL POWER (W)	13.2W	13.2W	13.2W
SYSTEM OUTPUT (LM)	948LM	948LM	948LM
CCT (K)	3000K	3000K	3000K
CRI (Ra)	90	90	90
BEAM ANGLE	11°	11°	11°
OPERATING VOLTAGE-VAC	220-240V	220-240V	220-240V
SOURCE POWER (W)	15W	15W	15W
SOURCE OUTPUT (LM)	199LM	199LM	199LM
DIMMING RANGE	30-100%	30-100%	30-100%
FLICKER FACTOR	107.33Hz / 1.14%	107.33Hz / 1.14%	107.33Hz / 1.14%
MOUNTING PLATE	D:φ395mm	D:φ395mm	D:φ395mm
TUBE DIMENSIONS	D:φ25 x H:350	D:φ25 x H:550	D:φ25 x H:750



MELA P IN / ON

PENDANTS

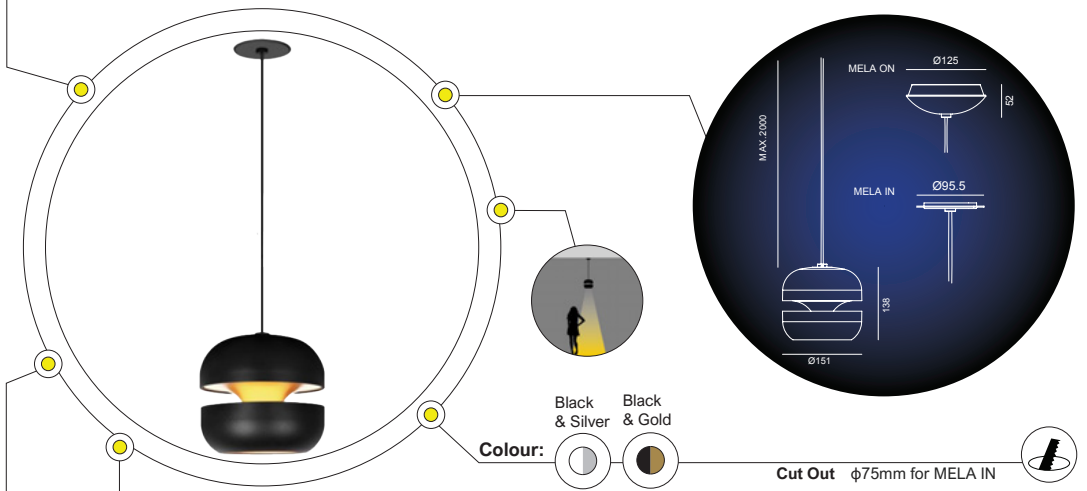

+ IP 20



LOA



3 YRS

ldt

PHYSICAL DATA

FEATURES

- Material: Aluminium
- The MELA P lights up your home in a dynamic and artsy way, the mid-hollow ring creates soft ambient light through diffused reflection while the lower emitting light beam fulfills your lighting demands to complete tasks below
- TRIAC Dimming
- Remote driver - driver in ceiling cup

OPTIONS & ACCESSORIES

- DALI and 0/1-10V Dimming options on request
- The MELA range offers track options for the LUCA and ULTRA Track Systems and the MELA P ON which is a surface suspended pendant option

MOUNTING: Mela IN - Recessed, Mela ON - Surface

APPLICATION AREAS: Indoor, Commercial, Residential, Retail, Hospitality

TECHNICAL DATA

LF333819DT

LF333719DT

	MELA IN	MELA ON
NAME	MELA IN	MELA ON
LAMP	LED	LED
TOTAL POWER (W)	14.9W	14.9W
SYSTEM OUTPUT (LM)	506LM	506LM
CCT (K)	3000K	3000K
CRI (RA)	90	90
BEAM ANGLE	360°	360°
OPERATING VOLTAGE-VAC	220-240V	220-240V
SOURCE POWER (W)	20W	20W
SOURCE OUTPUT (LM)	1872LM	1872LM
DIMMING RANGE	30-100%	30-100%
CURRENT (MA)	500MA	500MA
FLICKER FACTOR	124HZ / 0.22%	124HZ / 0.22%
MOUNTING TYPE	RECESSED	SURFACE
LAMP DIMENSIONS	D:φ151 x L:138mm	D:φ151 x L:138mm
CUT OUT	D:φ75mm	n/a

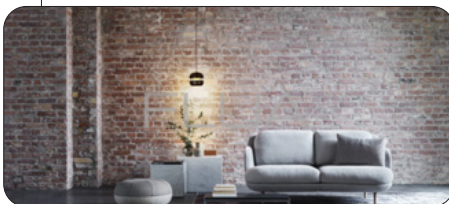

CD / KLM

● C0 - C180

● C90 - C270

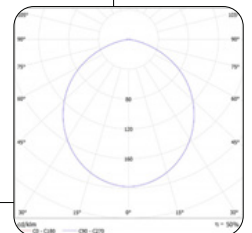

E&OE MAY OCCUR

PROMEO

PENDANTS

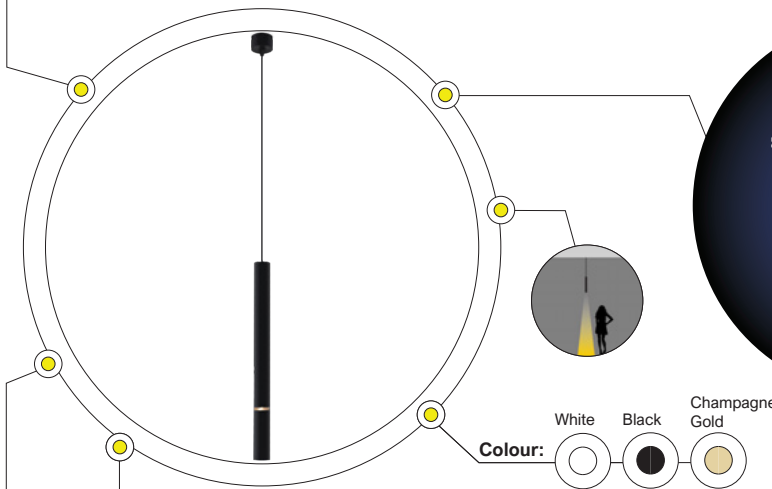

+ IP 20



LOA

3 YRS

ldt



PHYSICAL DATA

FEATURES

- Material: Stainless Steel
- Simple, elegant timeless classic with splendid slim fitting with small lighting ring gives the cylinder an additional decorative element to the whole design concept
- 12° Beam angle provides special emphasis lighting effect

OPTIONS & ACCESSORIES

- Available in three lengths; 203, 303mm and 403mm
- PROMEO available for the ULTRA and LUCA track systems

MOUNTING: Suspended

APPLICATION AREAS

Indoor, Commercial, Residential, Retail, Hospitality

TECHNICAL DATA

LF334617A

LF334517A

LF334417A

LAMP	LED	LED	LED
TOTAL POWER (W)	2.2W	2.2W	2.2W
SYSTEM OUTPUT (LM)	28LM	28LM	28LM
CCT (K)	3000K	3000K	3000K
CRI (Ra)	80	80	80
BEAM ANGLE	12°	12°	12°
OPERATING VOLTAGE-VAC	100-240V	100-240V	100-240V
SOURCE POWER (W)	4.2W	4.2W	4.2W
SOURCE OUTPUT (LM)	177LM	177LM	177LM
CUP DIMENSIONS	D:φ84.5 x H:35mm	D:φ84.5 x H:35mm	D:φ84.5 x H:35mm
LUMINAIRE DIMENSIONS	D:φ32 x H:203mm	D:φ32 x H:303mm	D:φ32 x H:403mm

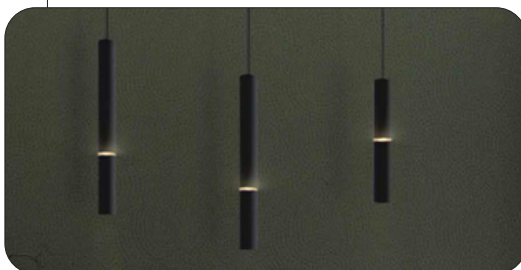

CD / KLM

● C0 - C180

● C90 - C270

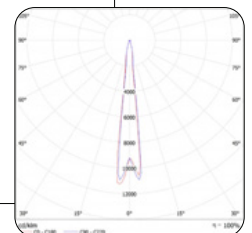

E&OE MAY OCCUR

WAVE H S 20 DN

PENDANTS

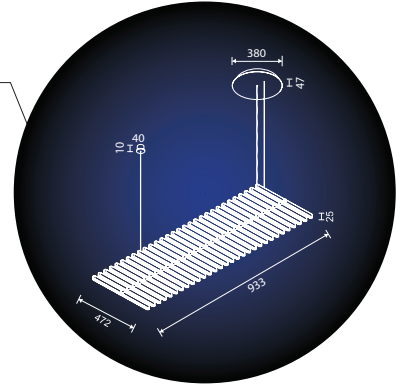
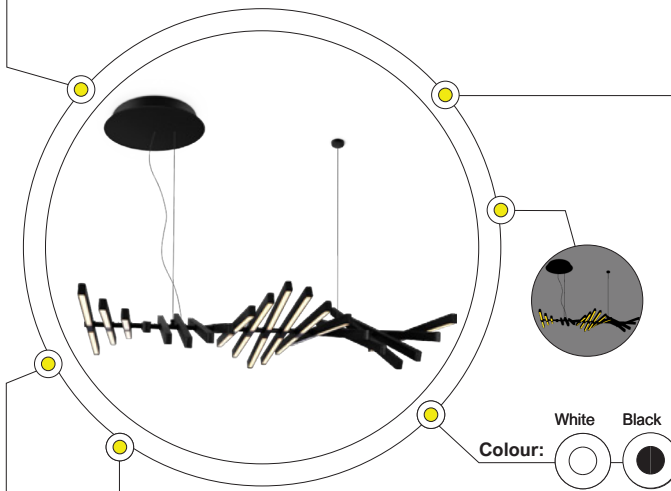

PHYSICAL DATA

+ IP 20



LOA

3 YRS

FEATURES

- Material: Plastic and Steel
- Unique minimalist design provides ambient and indirect illumination
- 0/1-10V Dimmable

- Available in a vertical design and various sizes depending on the length and amount of light sticks
- Other CCT (K) available
- DALI Dimming available for selection

OPTIONS & ACCESSORIES

- WAVE H S length options also available for selection: 468mm and 1453mm lengths

MOUNTING: Suspended

APPLICATION AREAS: Indoor, Commercial, Residential, Retail, Hospitality

TECHNICAL DATA

LF309519DX

LAMP	LED
TOTAL POWER (W)	55W
SYSTEM OUTPUT (LM)	2770LM
CCT (K)	3000K
CRI (Ra)	80
BEAM ANGLE	180°
OPERATING VOLTAGE-VAC	100-240V
SOURCE POWER (W)	64.7W
DIMMING RANGE	10-100%
WEIGHT (KG)	5.2KG
DIMENSIONS	L:933 x W:472 x H:25mm

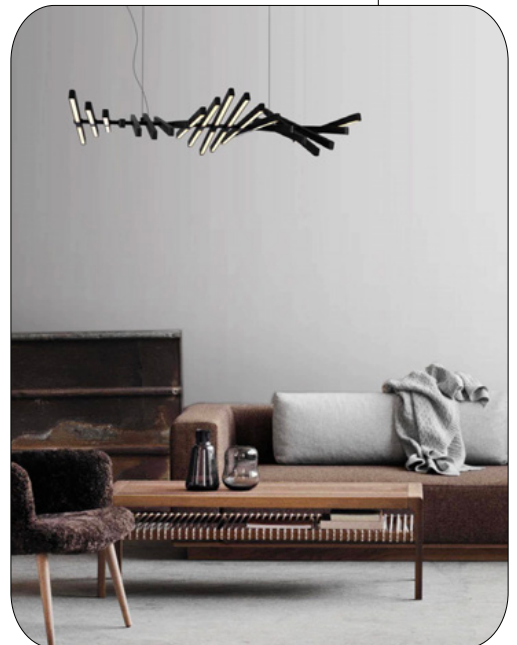

E&OE MAY OCCUR

WAVE H S 30 DN

PENDANTS

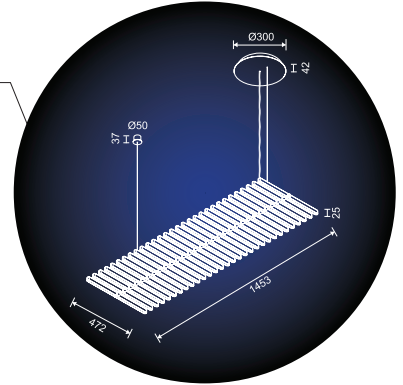
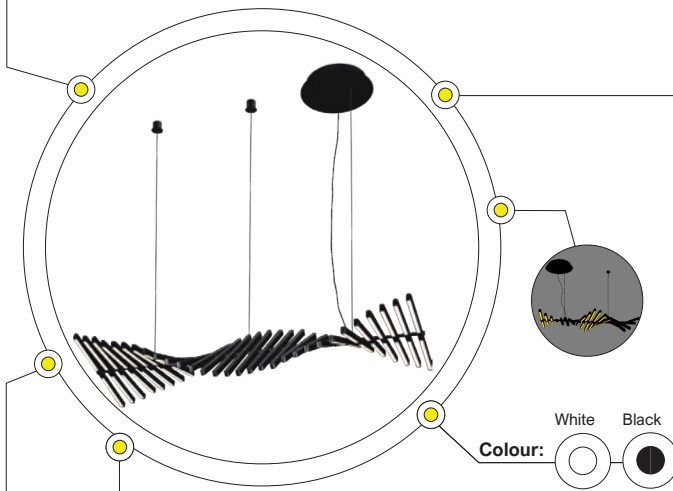

+ IP 20



LOA

3 YRS

PHYSICAL DATA

FEATURES

- Material: Plastic and Steel
- Unique minimalist design provides ambient and in-direct illumination
- 0/1-10V Dimmable

OPTIONS & ACCESSORIES

- WAVE H S length options also available for selection: 468mm and 933mm lengths

- Available in a vertical design and various sizes depending on the length and amount of light sticks
- Other CCT (K) available
- DALI Dimming available for selection

MOUNTING: Suspended

APPLICATION AREAS: Indoor, Commercial, Residential, Retail, Hospitality

TECHNICAL DATA

LF305819DX

LAMP	LED
TOTAL POWER (W)	75W
SYSTEM OUTPUT (LM)	4150LM
CCT (K)	3000K
CRI (Ra)	80
BEAM ANGLE	180°
OPERATING VOLTAGE-VAC	100-240V
SOURCE POWER (W)	83W
DIMMING RANGE	10-100%
WEIGHT (KG)	10.5KG
DIMENSIONS	L:1453 x W:472 x H:25mm

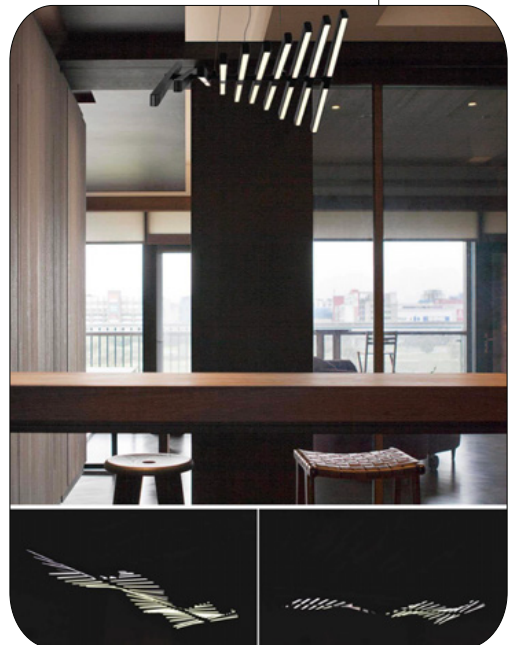
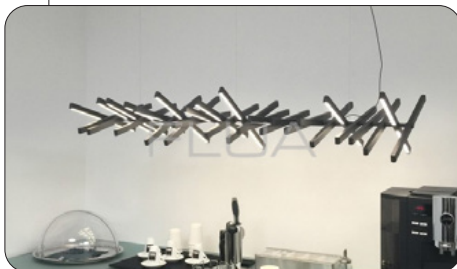

E&OE MAY OCCUR

WAVE V L 30 UP

PENDANTS

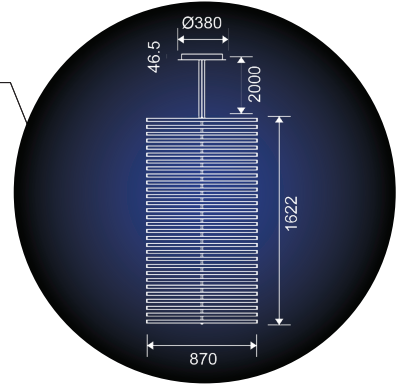
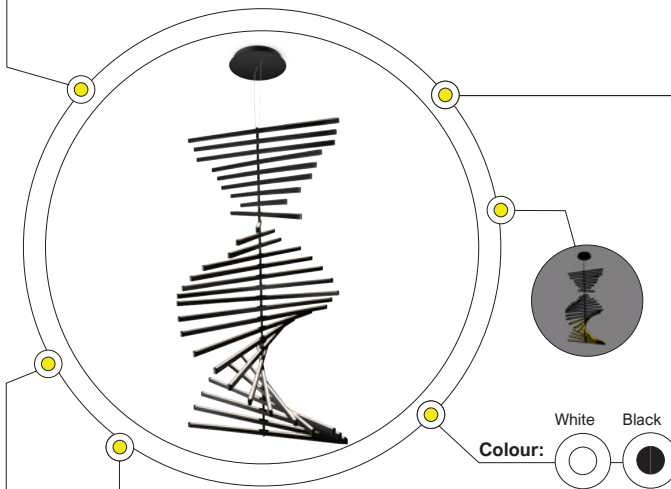

+ IP 20



LOA

3 YRS

PHYSICAL DATA

FEATURES

- Material: Plastic and Steel
- Unique minimalist design provides ambient and indirect illumination
- 0/1-10V Dimmable

OPTIONS & ACCESSORIES

- WAVE V L 20 UP available for selection: L:1080mm
- Available in a horizontal design and various sizes

- depending on the length and amount of light sticks
- Other CCT (K) available

MOUNTING

Suspended

APPLICATION AREAS

Indoor, Commercial, Residential, Retail, Hospitality

TECHNICAL DATA

LF310119DX

LAMP	LED
TOTAL POWER (W)	150W
SYSTEM OUTPUT (LM)	8250LM
CCT (K)	3000K
CRI (Ra)	80
BEAM ANGLE	180°
OPERATING VOLTAGE-VAC	100-240V
SOURCE POWER (W)	163W
DIMMING RANGE	10-100%
DIMENSIONS	L:870 x W:20 x H:1622mm

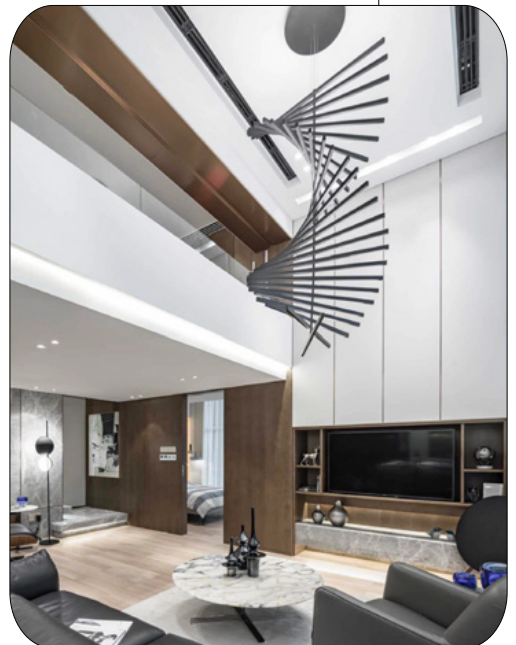

E&OE MAY OCCUR

LP18E27

PENDANTS

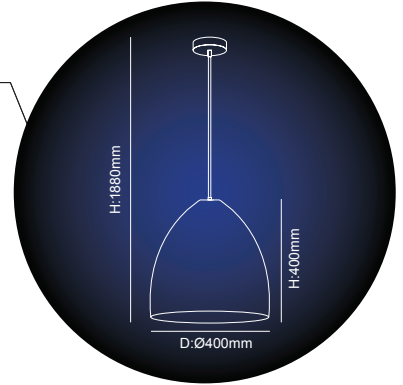
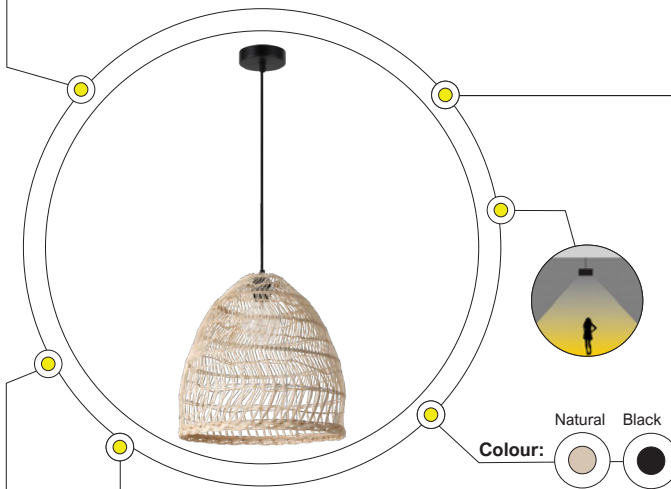

PHYSICAL DATA

FEATURES

- Material: Natural woven bamboo

MOUNTING

Suspended

APPLICATION AREAS

Indoor, Outdoor, Commercial, Residential, Retail, Hospitality

TECHNICAL DATA

LP18E27

LAMP HOLDER	E27 40W
VOLTAGE	230V 40W
FITTING HEIGHT	H:1880mm
SHADE DIMENSIONS	D:φ400 x H:400mm

LAMP DATA

HX-LSG80-4W

LAMP	LED SPIRAL FILAMENT
	CLEAR GLASS
SHAPE	BALL SPIRAL BULB
BASE	E27
DIMMABLE	YES - DIMMABLE
TOTAL POWER (W)	4W
CCT (K)	2200K
CRI (RA)	80
RATED LIFE (HRS)	15 000HRS
OPERATING VOLTAGE	240V



PLEASE NOTE

Lamp specifications and lamp warranties may differ

LP19E27

PENDANTS

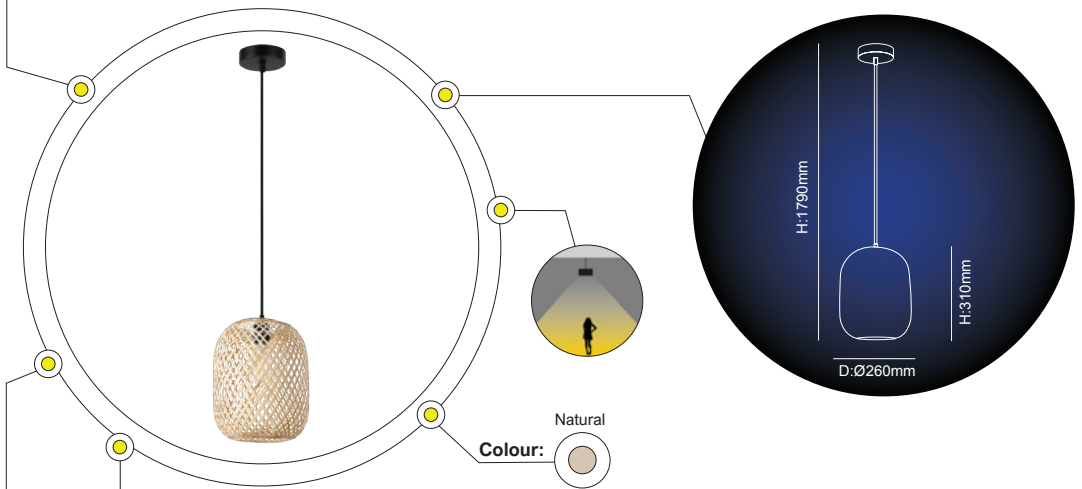

Colour: 

PHYSICAL DATA

FEATURES

- Material: Natural woven bamboo

MOUNTING

Suspended

APPLICATION AREAS

Indoor, Outdoor, Commercial, Residential, Retail, Hospitality

+ IP 20



TECHNICAL DATA

LP19E27

LAMP HOLDER	E27 40W
VOLTAGE	230V 40W
FITTING HEIGHT	H:1790mm
SHADE DIMENSIONS	D:φ260 x H:310mm

LAMP DATA

HX-LSG80-4W

LAMP	LED SPIRAL FILAMENT
	CLEAR GLASS
SHAPE	BALL SPIRAL BULB
BASE	E27
DIMMABLE	YES - DIMMABLE
TOTAL POWER (W)	4W
CCT (K)	2200K
CRI (RA)	80
RATED LIFE (HRS)	15 000HRS
OPERATING VOLTAGE	240V



PLEASE NOTE

Lamp specifications and lamp warranties may differ

LP20E27

PENDANTS

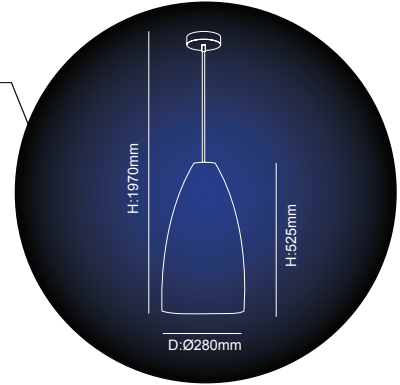
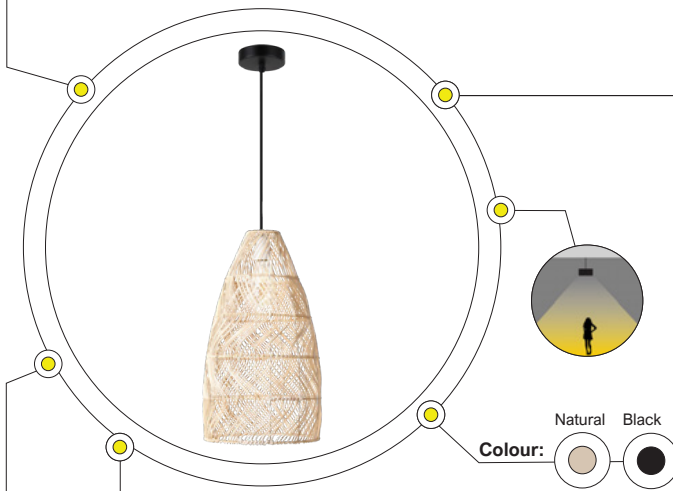

+ IP 20



✓ 1 YR

PHYSICAL DATA

FEATURES

- Material: Natural woven bamboo

MOUNTING

Suspended

APPLICATION AREAS

Indoor, Outdoor, Commercial, Residential, Retail, Hospitality

TECHNICAL DATA

LP20E27

LAMP HOLDER	E27 40W
VOLTAGE	230V 40W
FITTING HEIGHT	H:1970mm
SHADE DIMENSIONS	D:φ280 x H:525mm

LAMP DATA

HX-LSG80-4W

LAMP	LED SPIRAL FILAMENT
	CLEAR GLASS
SHAPE	BALL SPIRAL BULB
BASE	E27
DIMMABLE	YES - DIMMABLE
TOTAL POWER (W)	4W
CCT (K)	2200K
CRI (RA)	80
RATED LIFE (HRS)	15 000HRS
OPERATING VOLTAGE	240V



PLEASE NOTE

Lamp specifications and lamp warranties may differ

E&OE MAY OCCUR

> CEILING

CEILING LIGHTS

CEILING - CEILING LIGHTS



Project Woodstock Quarter

DOMO 2.1 ON

CEILING LIGHT

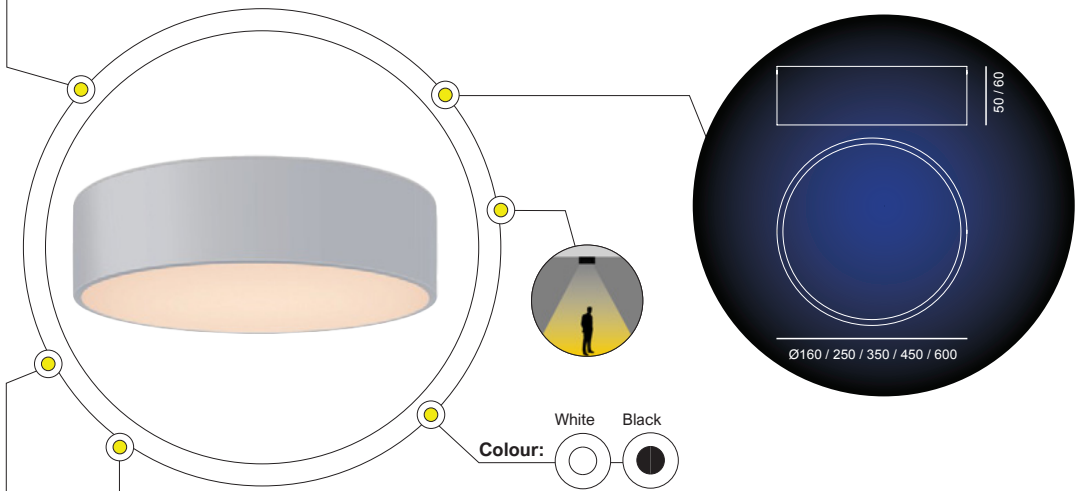

+ IP 20



LOA

3 YRS

PHYSICAL DATA

FEATURES

- Material: Aluminium
- Soft, comfortable lighting
- Simplistic, modern design
- TRIAC dimmable

OPTIONS & ACCESSORIES

- The DOMO range offers a wide variety of lighting options; from track lights, recessed trimless adjustable

and non-adjustable, adjustable surface ceiling lights as well as the up/down illuminated ceiling light

MOUNTING

Surface

APPLICATION AREAS

Indoor, Commercial, Residential, Retail, Hospitality

TECHNICAL DATA

LF223914DTW

LF224014DTW

LF224114DTW

LF223214DTW

LF223314DTW

LAMP	LED	LED	LED	LED	LED
TOTAL POWER (W)	14W	26W	43W	45.7W	66.6W
SYSTEM OUTPUT (LM)	712LM	1205LM	2360LM	3592LM	5366LM
CCT (K)	3000K	3000K	3000K	3000K	3000K
CRI (Ra)	80	80	80	80	80
OPERATING VOLTAGE-VAC	220-240V	220-240V	220-240V	220-240V	220-240V
SOURCE POWER (W)	14W	26W	43W	45.7W	66.6W
FLICKER FACTOR	100HZ / 32.92%	99.83HZ / 21.26%	100HZ / 35.58%	100HZ / 34.21%	100HZ / 32.82%
DIMENSIONS	D:φ160 x H:50mm	D:φ250 x H:60mm	D:φ350 x H:60mm	D:φ450 x H:60mm	D:φ600 x H:60mm



E&OE MAY OCCUR

DOMO 2.1 ON 2

CEILING LIGHT

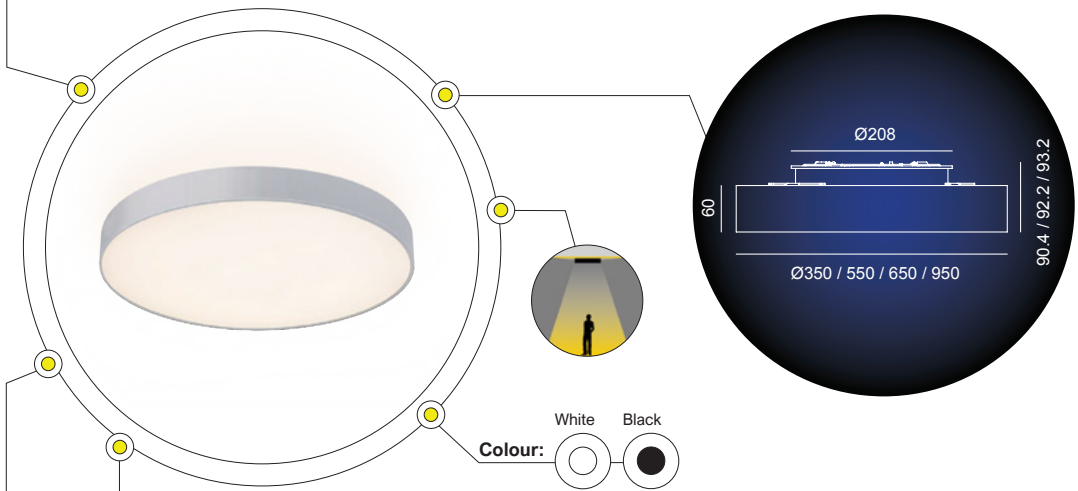

PHYSICAL DATA

FEATURES

- Material: Aluminium
- The DOMO 2.1 ON 2 offers soft, comfortable lighting with a simplistic modern design that is easy to install
- Illuminates from the top and bottom of luminaire
- 3-step control; select either up or down illumination or both
- 1-10V Dimmable

- Turnable White-App dimming option available
- The DOMO range offers a wide variety of lighting options; from track lights, recessed trimless adjustable and non-adjustable, adjustable surface ceiling lights as well as the up/down illuminated ceiling light

MOUNTING: Surface

APPLICATION AREAS: Indoor, Commercial, Residential, Retail, Hospitality

OPTIONS & ACCESSORIES



TECHNICAL DATA

LF223714DX

LF221914DX

LF222214DX

LF222514DX

	LF223714DX	LF221914DX	LF222214DX	LF222514DX
LAMP	LED	LED	LED	LED
TOTAL POWER (W)	28.35 + 5.45W	39.06 + 7.36W	59.7 + 9.87W	95.5 + 12.45W
SYSTEM OUTPUT (LM)	1854LM	2858LM	4905LM	8246LM
CCT (K)	3000K	3000K	3000K	3000K
CRI (Ra)	90	90	90	90
OPERATING VOLTAGE-VAC	220-240V	220-240V	220-240V	220-240V
SOURCE POWER (W)	40.3W	52.7W	80.9W	118W
DIMMING RANGE	10-100%	10-100%	10-100%	10-100%
FLICKER FACTOR	296HZ / 0.22%	100HZ / 0.26%	101.69HZ / 0.65%	101.69HZ / 0.65%
DIMENSIONS	D:φ350 x H:90.4mm	D:φ450 x H:92.2mm	D:φ650 x H:93.2mm	D:φ950 x H:93.2mm

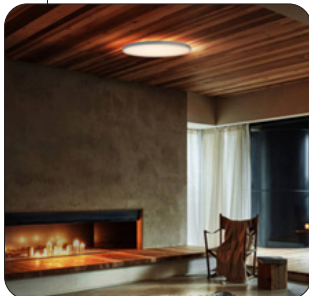

E&OE MAY OCCUR

MOONY M

CEILING LIGHT

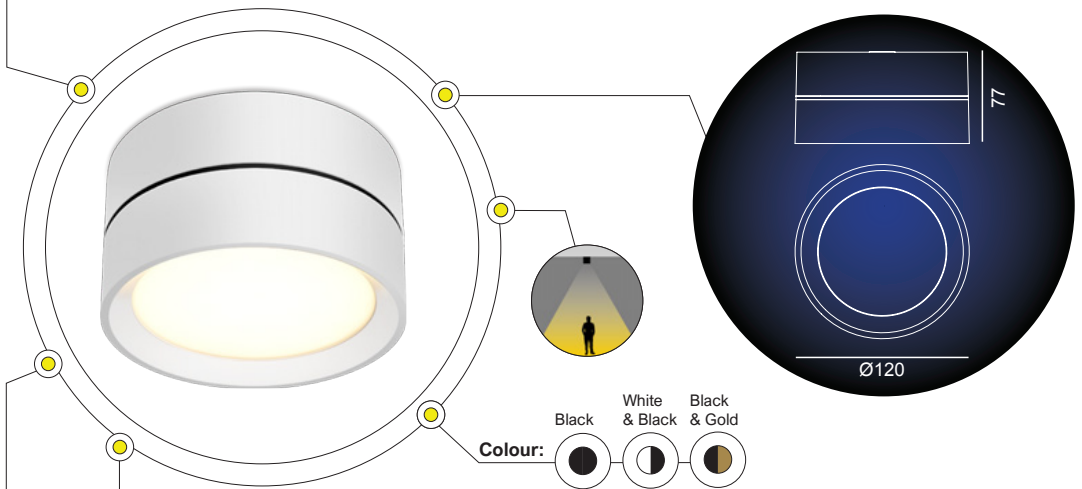

+ IP 54



LOA

3 YRS

ldt

PHYSICAL DATA

FEATURES

- Material: Aluminium
- The MOONY is a classical surface mounted series that is extremely versatile and can be used in both interior or exterior applications
- Simple minimalistic design
- Diffused lighting effect
- Low flicker

OPTIONS & ACCESSORIES

- TRIAC Dimmable option available
- Moony M Spot with narrower beam option available

MOUNTING

Surface

APPLICATION AREAS

Indoor, Commercial, Residential, Retail, Hospitality

TECHNICAL DATA

LF202017A

LAMP	LED
TOTAL POWER (W)	13.61W
SYSTEM OUTPUT (LM)	690LM
CCT (K)	2700 / 3000 / 4000K
CRI (Ra)	80
BEAM ANGLE	180°
OPERATING VOLTAGE-VAC	220-240V
SOURCE POWER (W)	11.6W
FLICKER FACTOR	99.83HZ/1.63%
WEIGHT (KG)	0.79KG
DIMENSIONS	D:φ120 x H:77mm



- CD / KLM
- C0 - C180
 - C90 - C270

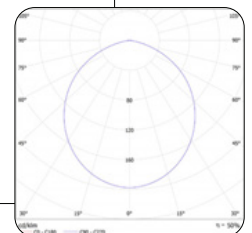

E&OE MAY OCCUR

MOONY M SPOT

CEILING LIGHT

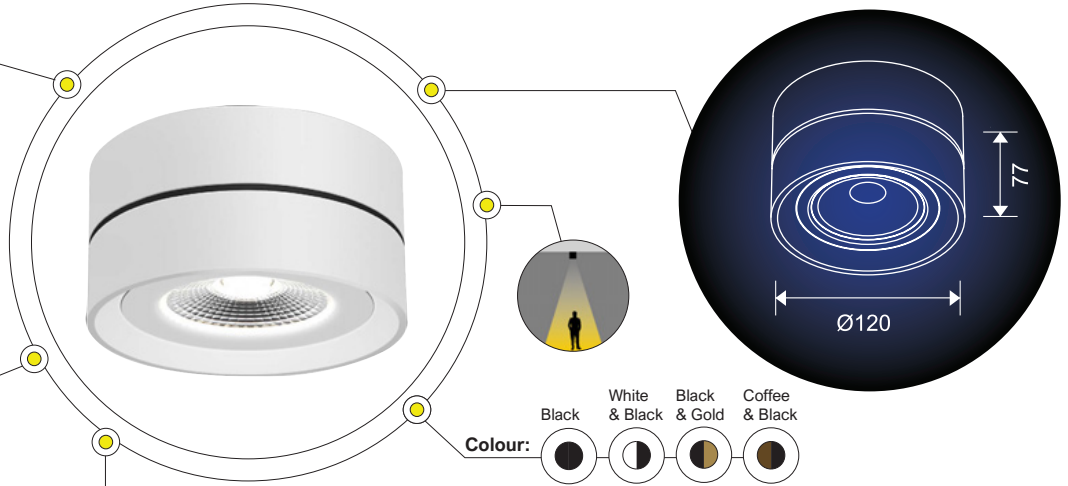

PHYSICAL DATA

FEATURES

- Material: Aluminium
- The MOONY is a classical surface mounted series that is extremely versatile and can be used in both interior or exterior applications
- Simple minimalistic design
- Low flicker
- TRIAC Dimmable

OPTIONS & ACCESSORIES

- Moony M with diffused light option available

MOUNTING

Surface

APPLICATION AREAS

Indoor, Commercial, Residential, Retail, Hospitality

+ IP 54



LOA

5 YRS

ldt

TECHNICAL DATA

LF208415DT

LAMP	LED
TOTAL POWER (W)	20.44W
SYSTEM OUTPUT (LM)	1624LM
CCT (K)	2700 / 3000 / 4000K
CRI (Ra)	80
BEAM ANGLE	38°
OPERATING VOLTAGE-VAC	220-240V
DIMMING RANGE	30-100%
SOURCE POWER (W)	17.4W
WEIGHT (KG)	0.71KG
DIMENSIONS	D:φ120 x H:77mm

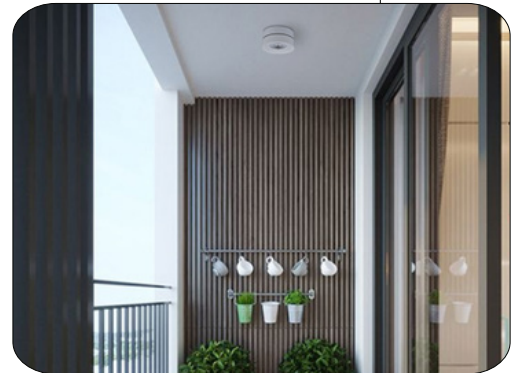

- CD / KLM
- C0 - C180
 - C90 - C270

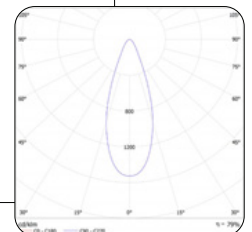

E&OE MAY OCCUR

MOONY L

CEILING LIGHT

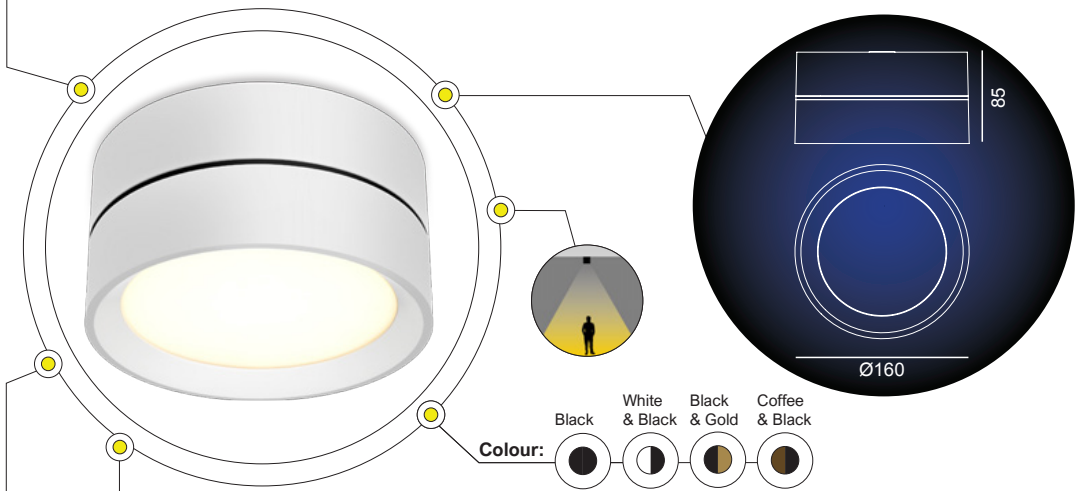

+IP 54



LOA

5 YRS

ldt

PHYSICAL DATA

FEATURES

- Material: Aluminium
- The MOONY is a classical surface mounted series that is extremely versatile and can be used in both interior or exterior applications
- Simple minimalistic design
- Low flicker
- TRIAC Dimmable
- Anti-glare

OPTIONS & ACCESSORIES

- Moony L Spot with 38° beam available
- Moony L Sensor option available (Infrared Induction Sensor)

MOUNTING

Surface

APPLICATION AREAS

Indoor, Commercial, Residential, Retail, Hospitality

TECHNICAL DATA

LF202016DT

LAMP	LED
TOTAL POWER (W)	17.2W
SYSTEM OUTPUT (LM)	1096LM
CCT (K)	2700 / 3000 / 4000K
CRI (Ra)	80
BEAM ANGLE	180°
OPERATING VOLTAGE-VAC	220-240V
DIMMING RANGE	30-100%
FLICKER FACTOR	107.33HZ / 1.4%
SOURCE POWER (W)	20W
WEIGHT (KG)	1.28KG
DIMENSIONS	D:φ160 x H:85mm



- CD / KLM
- C0 - C180
 - C90 - C270

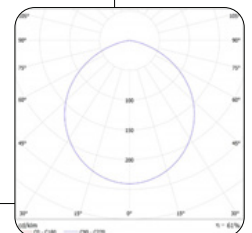

E&OE MAY OCCUR

MOONY L SPOT

CEILING LIGHT

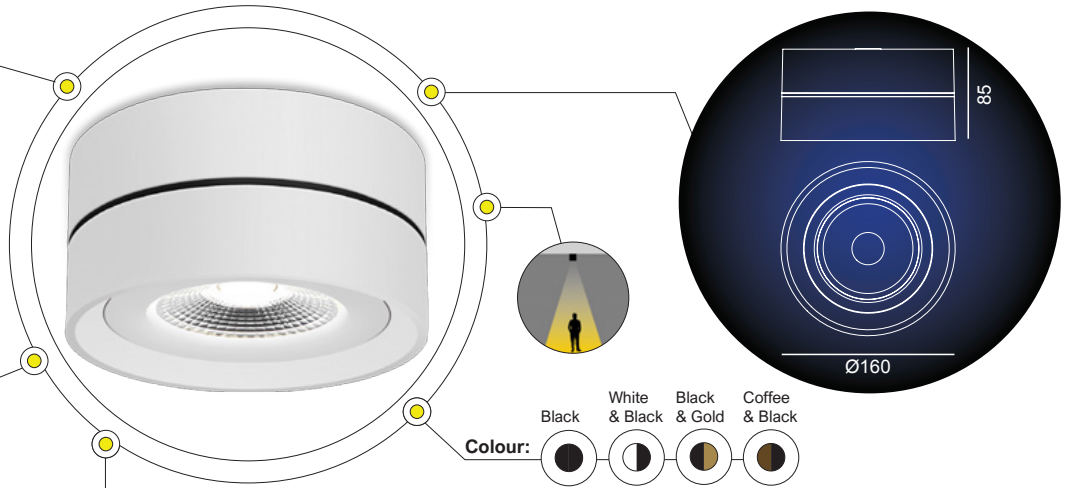

PHYSICAL DATA

FEATURES

- Material: Aluminium
- The MOONY is a classical surface mounted series that is extremely versatile and can be used in both interior or exterior applications
- Simple minimalistic design
- Low Flicker

OPTIONS & ACCESSORIES

- Moony L with diffused light option available

MOUNTING

Surface

APPLICATION AREAS

Indoor, Commercial, Residential, Retail, Hospitality

+IP
54



LOA

2 YRS

ldt

TECHNICAL DATA

LF208515A

LAMP	LED
TOTAL POWER (W)	24.7W
SYSTEM OUTPUT (LM)	2121LM
CCT (K)	2700 / 3000 / 4000K
CRI (Ra)	80
BEAM ANGLE	38°
OPERATING VOLTAGE-VAC	100-240V
SOURCE POWER (W)	29W
FLICKER FACTOR	109.69HZ / 0.37%
WEIGHT (KG)	1.18 KG
DIMENSIONS	D:φ160 x H:85mm



- CD / KLM
- C0 - C180
 - C90 - C270

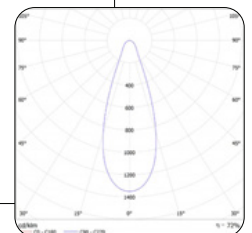

E&OE MAY OCCUR

STUDIO

CEILING LIGHT

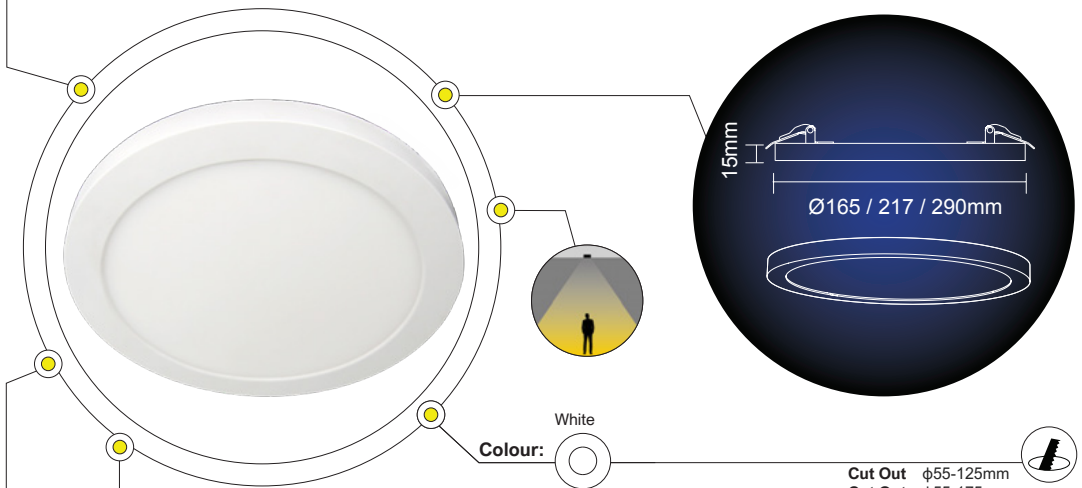

Cut Out ϕ 55-125mm
Cut Out ϕ 55-175mm
Cut Out ϕ 60-250mm

+ IP 54



LOA

2 YRS

ldt

PHYSICAL DATA

FEATURES

- Material: Polycarbonate housing with polystyrene diffuser
- Adjustable stainless steel mounting bracket allowing mounting in cut-outs of 55-125mm for the 12W
- Adjustable stainless steel mounting bracket allowing mounting in cut-outs of 55-175mm for the 18W
- Adjustable stainless steel mounting bracket allowing mounting in cut-outs of 60-250mm for the 24W
- TRIAC dimmable luminaire
- CCT selectable between 3000K, 4000K and 6500K

using switch on the back of the fitting

- Comes with magnet to allow easy clip-on mounting of accessory trims
- Pre-wired with 170mm flex
- Suitable for switching by PIR, Microwave or Photocell

MOUNTING: Recessed or Surface

APPLICATION AREAS: Indoor, Commercial, Hospitality Retail, Educational Sector, Hospitals

TECHNICAL DATA

	RSD12CCT3M-01	RSD18CCT3M-01	RSD24CCT3M-01
LAMP	LED	LED	LED
TOTAL POWER (W)	12.5 / 12.8 / 12.6W	18.1 / 18.6 / 18.2W	22.8 / 23.5 / 22.7W
SYSTEM OUTPUT (LM)	970 / 1080 / 990LM	1620 / 1770 / 1590LM	1820 / 2100 / 1870LM
EFFICACY (LM/W)	77 / 84 / 79	89 / 95 / 87	80 / 90 / 83
CCT (K)	3000 / 4000 / 6500K	3000 / 4000 / 6500K	3000 / 4000 / 6500K
CRI (RA)	80	80	80
BEAM ANGLE	110°	110°	110°
OPERATING VOLTAGE	220-240V	220-240V	220-240V
OPERATING TEMP (°C)	-20°C to +40°C	-20°C to +40°C	-20°C to +40°C
RATED LIFE (HRS)	20 000HRS	20 000HRS	20 000HRS
POWER FACTOR	0.9	0.9	0.9
WEIGHT (KG)	0.2KG	0.35KG	0.6KG
ILLUM @ 1M (LUX)	330 / 370 / 340	630 / 730 / 650	630 / 730 / 650
DIMENSIONS	D: ϕ 165 x H:15mm	D: ϕ 217 x H:15mm	D: ϕ 290 x H:15mm
CUT OUT	D: ϕ 55-125mm	D: ϕ 55-175mm	D: ϕ 60-250mm

Reverse view of the STUDIO downlight



RSD 12 / 24 TRIM-04 & RSD 12 / 24 TRIM-13

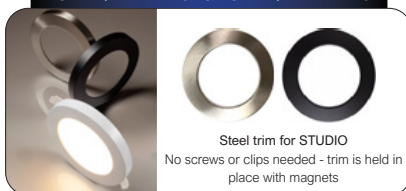

CD / KLM

- C0 - C180
- C90 - C270

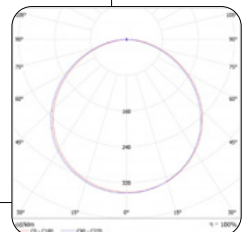

E&OE MAY OCCUR

LSD09

CEILING LIGHT

CEILING - CEILING LIGHTS - LSD09

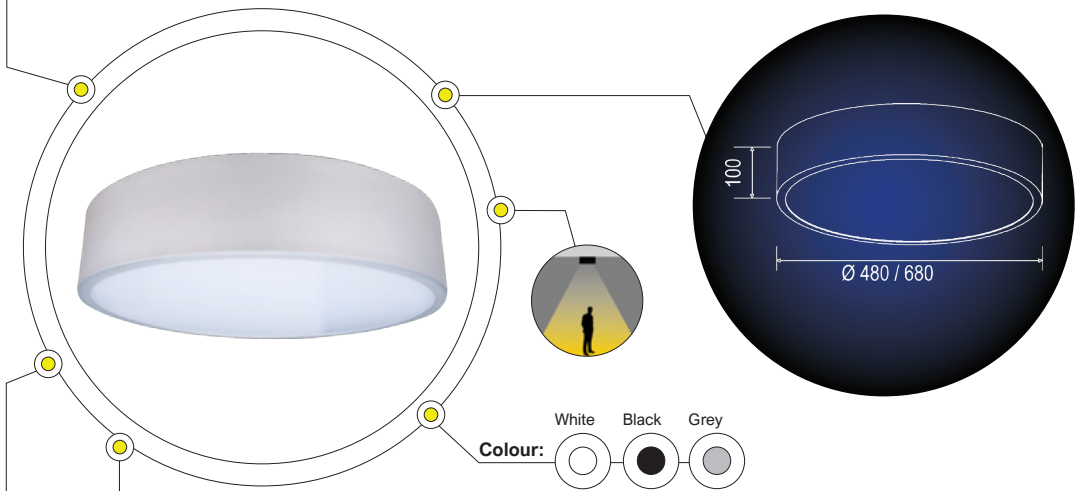

+ IP 20



LOA

5 YRS

ldt



PHYSICAL DATA

FEATURES

- Material: Aluminium and polycarbonate
- Flood LED panel light

MOUNTING

Surface

OPTIONS & ACCESSORIES

- Pendant, Recessed versions available
- TRIAC, 0-10V, Dali dimming options available

APPLICATION AREAS

Indoor, Commercial, Residential, Retail, Hospitality

TECHNICAL DATA

LSD0932

LSD0966

	LSD0932	LSD0966
LAMP	LED	LED
TOTAL POWER (W)	32W	66W
SYSTEM OUTPUT (LM)	3468 / 3529LM	7250 / 7577LM
EFFICACY (LM/W)	108 / 105	107 / 115
CCT (K)	3500 / 4000K	3500 / 4000K
CRI (Ra)	80	80
BEAM ANGLE	108°	111°
RATED LIFE (HRS)	50 000 HRS	50 000 HRS
OPERATING VOLTAGE-VAC	220-240V	220-240V
CURRENT (MA)	700MA	1400MA
SOURCE POWER (W)	30W	60W
SOURCE OUTPUT (LM)	4359 / 4435LM	8150 / 8100LM
ILLUM @ 1M (LUX)	455 / 451LX	759 / 793LX
FLICKER FACTOR	<4%	<4%
OPERATING TEMP °C	-20°C TO 50°C	-20°C TO 50°C
POWER FACTOR	≥0.9	≥0.9
R9 VALUE	11	17
UGR	<25	<25
MAC ADAM STEP	3SDCM	3SDCM
DIMENSIONS	D:φ480 x H:100mm	D:φ680 x H:100mm

LSD1627

CEILING LIGHTS

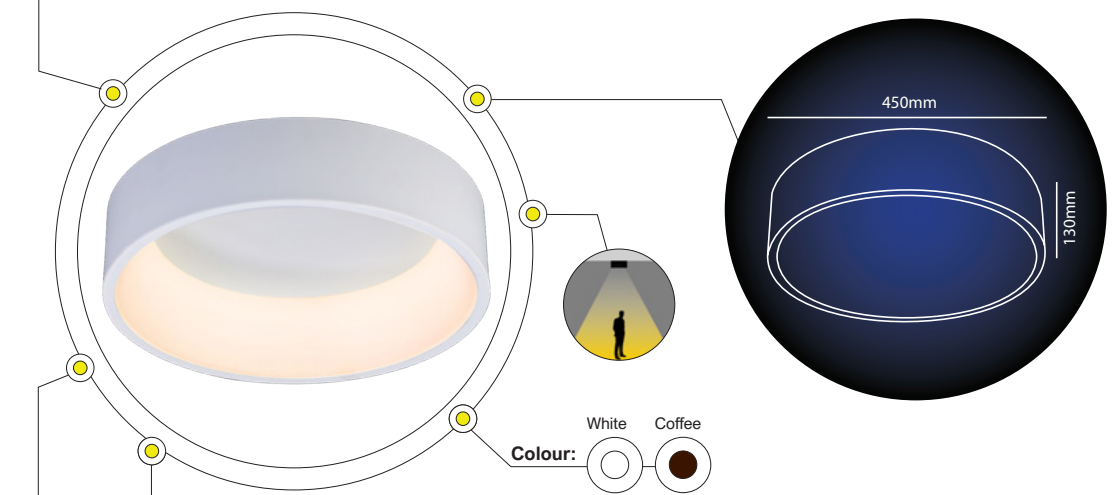

+ IP 20



✓ 1 YR

PHYSICAL DATA

FEATURES

- Material: metal with opal diffuser

OPTIONS & ACCESSORIES

- Dimmable on request

MOUNTING

Surface

APPLICATION AREAS

Indoor, Commercial, Residential, Retail, Hospitality

TECHNICAL DATA

LSD1627

LAMP	LED
TOTAL POWER (W)	27W
SYSTEM OUTPUT (LM)	1620LM
CCT (K)	3000 / 4000K
CRI (RA)	90
BEAM ANGLE	180°
OPERATING VOLTAGE-VAC	230V
DIMENSIONS	D:φ450 x H:130mm

> RECESSED SPOTS

COMMERCIAL & ARCHITECTURAL

CEILING – RECESSED SPOTS



Project: House Fischer / Lighting Design: Dominique Paronitti / Photography: Archigraphy

FAVOR INS

RECESSED SPOTLIGHTS

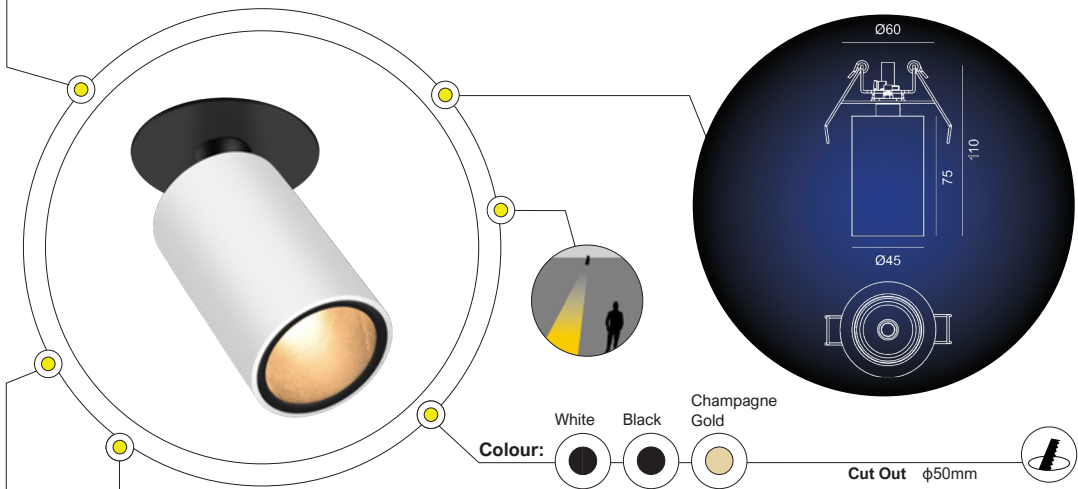

+IP 20



LOA

3 YRS

ldt



PHYSICAL DATA

FEATURES

- Material: Aluminium
- It is a great choice for accent lighting in both residential and commercial spaces
- Rotatable and adjustable affords this luminaire great versatility

OPTIONS & ACCESSORIES

- DALI and ON/OFF options available
- 8W option available

- FAVOR INM available: D:60 x H:135mm
- The FAVOR offers a wide range of choices from narrow to wide beam angles, from recessed to surface mounted and track applications; offering different color finishes and accessory combinations

MOUNTING: Recessed

APPLICATION AREAS: Indoor, Commercial, Residential, Retail, Hospitality

TECHNICAL DATA

LF178712EDT

LAMP	LED
TOTAL POWER (W)	9.5W
SYSTEM OUTPUT (LM)	388LM
CCT (K)	2700 / 3000 / 4000K
CRI (Ra)	90
BEAM ANGLE	28° / 19°

OPERATING VOLTAGE-VAC	220-240V
SOURCE POWER (W)	11.4W
SOURCE OUTPUT (LM)	957LM
CURRENT (MA)	500MA
FLICKER FACTOR	102.74HZ / 0.55%
WEIGHT	0,3KG
DIMENSIONS	D:Ø45 x 75mm
CUT OUT	D:Ø50mm

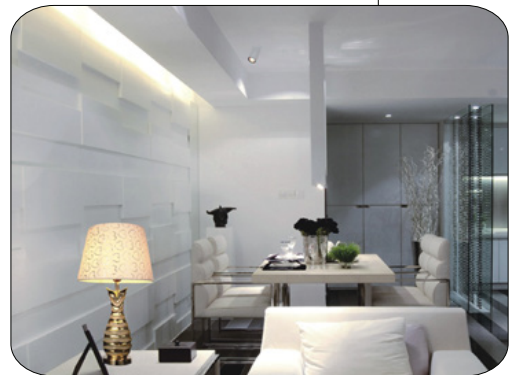

- CD / KLM
- C0 - C180
 - C90 - C270

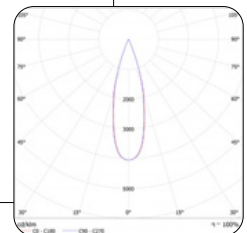

E&OE MAY OCCUR

LRS01

RECESSED SPOTLIGHTS

CEILING - RECESSED SPOTS - LRS01

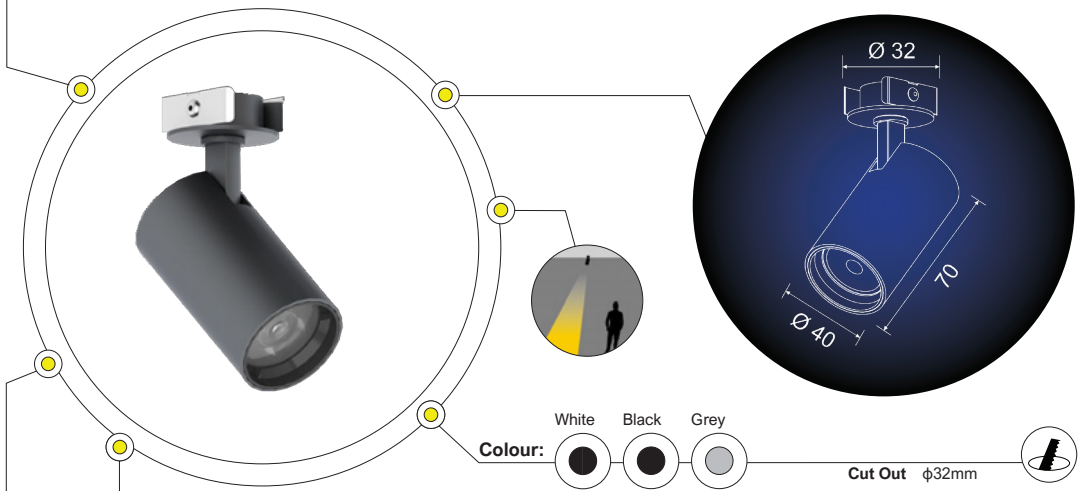

+IP 20



LOA

5 YRS

ldt

PHYSICAL DATA

FEATURES

- Better heat dissipation with higher density aluminium alloy body
- Superior lighting spot with high-quality optical lens
- Compact design, Directional
- Spring-clip fixing recessed version

OPTIONS & ACCESSORIES

- Available in 3000K and 3500K as well as special CCT

options available for the lighting of meat, bread, fish, vegetables and clothing

MOUNTING

Recessed

APPLICATION AREAS

Indoor, Commercial, Residential, Retail, Hospitality

TECHNICAL DATA

LRS01

LAMP	LED
TOTAL POWER (W)	3 / 11W
SYSTEM OUTPUT (LM)	182 / 891LM
EFFICACY (LM/W)	53 / 80W
CCT (K)	4000K
CRI (Ra)	80
BEAM ANGLE	14 / 29°
OPERATING VOLTAGE-VAC	220-240V
OPERATING TEMP °C	-20°C TO 50°C
SOURCE POWER (W)	2 / 6W
SOURCE OUTPUT (LM)	210 / 1653LM
CURRENT (MA)	700 / 250MA
FLICKER FACTOR	<4%
POWER FACTOR	≥0.9
ILLUM @ 1M (LUX)	1230 / 1556LX
R9 VALUE	9 / 11
UGR	<7
MACADAM STEP	3SDCM
RATED LIFE	50 000HRS
WEIGHT (KG)	0.2 / 0.23KG
DIMENSIONS	D:φ40 x 70mm
CUT OUT	D:φ32mm

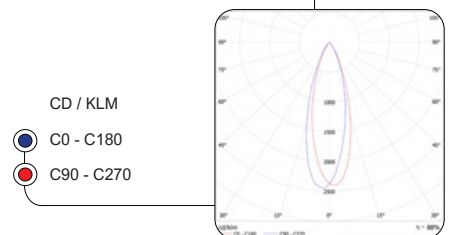

E&OE MAY OCCUR

> SURFACE SPOTS

COMMERCIAL & ARCHITECTURAL



FAVOR ONL 18 REFLECTOR

SURFACE DOWNLIGHTS

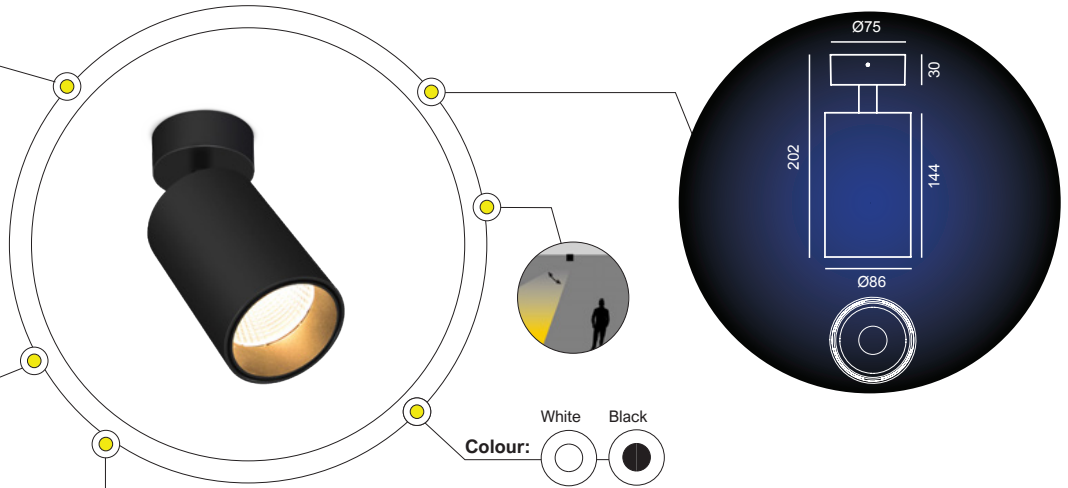

PHYSICAL DATA

FEATURES

- Material : Aluminium
- The FAVOR ONL 18 Reflector has a hidden deep light source that serves as an anti-glare and provides sufficient brightness
- Adjustable: body rotation of 355°, lamp head tilts 180°
- TRIAC Dimming

OPTIONS & ACCESSORIES

- The FAVOR ONL 18 Reflector offers On/Off function or selection
- The FAVOR ONL 25 offers both TRIAC DIM and On/Off function for selection

- The Favor ONM ER offers a standard On/Off functionality
- The FAVOR range offers a wide range of choices from narrow to wide beam angles, pendants, recessed to surface mounted luminaires as well as track applications; offering different color finishes and accessory combinations

MOUNTING: Surface

APPLICATION AREAS

Indoor, Commercial, Residential, Retail, Hospitality

TECHNICAL DATA

LF217915EDT

LAMP	LED
TOTAL POWER (W)	18W
SYSTEM OUTPUT (LM)	1045LM
CCT (K)	2700 / 3000 / 4000K
CRI (Ra)	90
BEAM ANGLE	25° / 15° / 36°

OPERATING VOLTAGE-VAC	220-240V
SOURCE POWER (W)	20W
SOURCE OUTPUT (LM)	2147LM
CURRENT (MA)	500MA
DIMMING RANGE	30-100%
FLICKER FACTOR	124HZ / 0.22%
WEIGHT (KG)	0.7KG
DIMENSIONS	D:φ86 x H:202mm

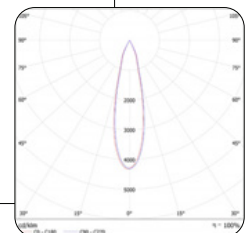
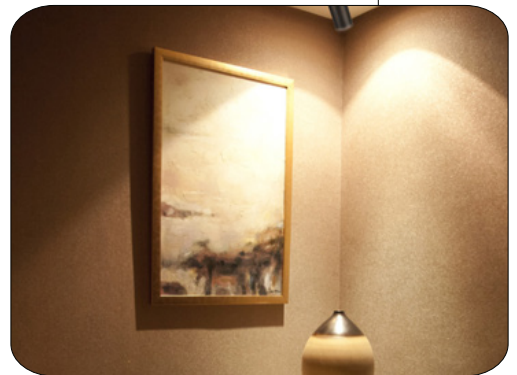

E&OE MAY OCCUR

FAVOR ONM ER

SURFACE DOWNLIGHTS

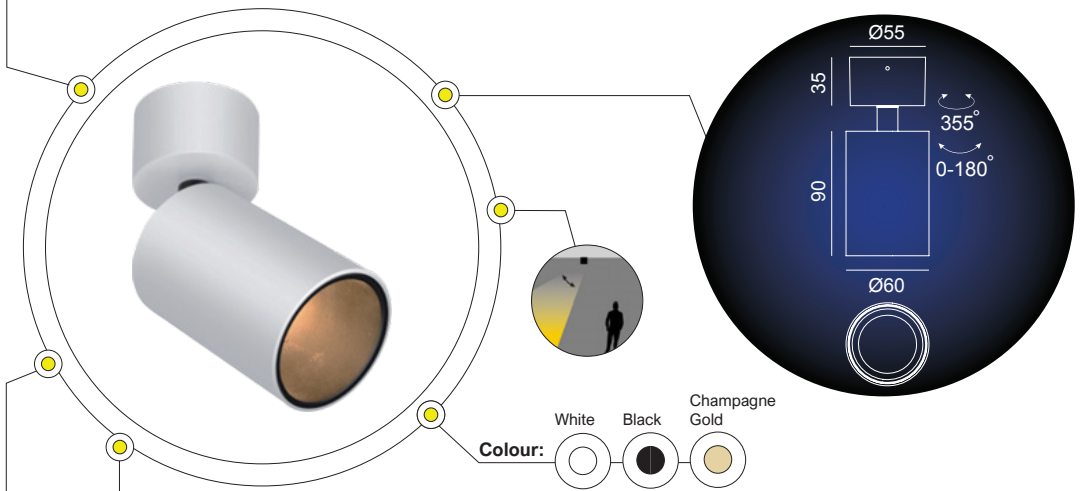

+ IP 20



LOA

5 YRS

ldt



PHYSICAL DATA

FEATURES

- Material : Aluminium
- The Favor ONM ER has a hidden deep light source that serves as an anti-glare and provides sufficient brightness
- Adjustable: body rotation of 355°; lamp head tilts 180°
- Driver: On/Off

OPTIONS & ACCESSORIES

- The FAVOR ONL 18 and FAVOR ONL 25; also surface mounted luminaires, offer TRIAC DIM and On/Off

functionality for selection

- The FAVOR range offers a wide range of choices from narrow to wide beam angles, pendants, recessed to surface mounted luminaires as well as track applications; offering different color finishes and accessory combinations

MOUNTING: Surface

APPLICATION AREAS

Indoor, Commercial, Residential, Retail, Hospitality

TECHNICAL DATA

LF210412EA

LAMP	LED
TOTAL POWER (W)	5.3W
SYSTEM OUTPUT (LM)	261LM
CCT (K)	2700 / 3000 / 4000K
CRI (Ra)	90
BEAM ANGLE	32° / 18°

OPERATING VOLTAGE-VAC	100-240V
SOURCE POWER (W)	6.4W
CURRENT (MA)	200MA
FLICKER FACTOR	789.47HZ / 3.71%
WEIGHT (KG)	0.4KG
DIMENSIONS	D:φ60 x H:144mm

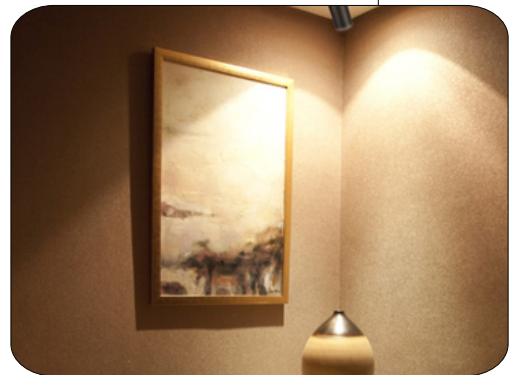

- CD / KLM
- C0 - C180
 - C90 - C270

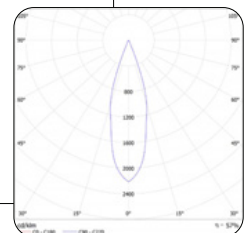

E&OE MAY OCCUR

> SURFACE SPOTS

GU10

CEILING - SURFACE SPOTS - GU10



DANNY MINI AIR GU10

GU10 SURFACE SPOT

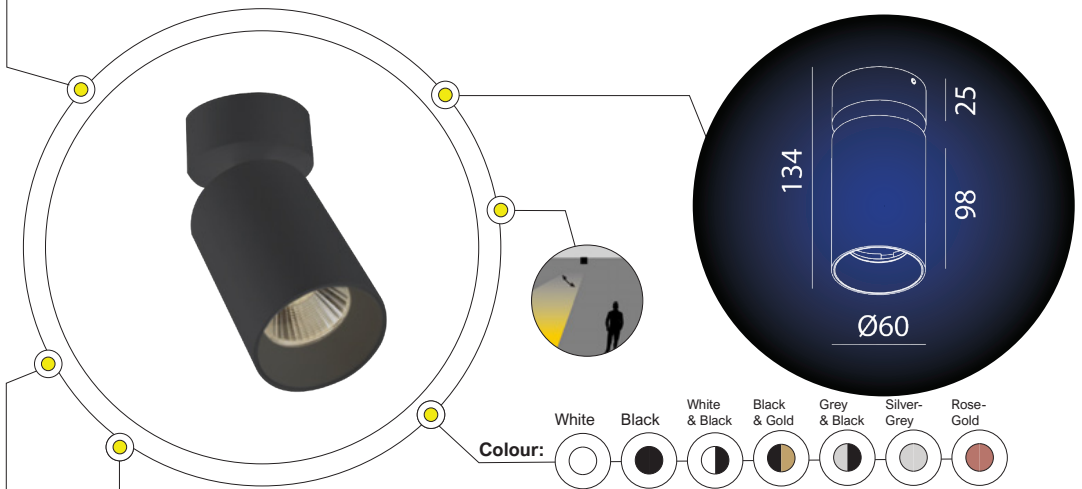

+ IP 20



LOA

3 YRS



PHYSICAL DATA

FEATURES

- Material: Die-cast aluminium
- Adjustable with spot-head adjust of 90° tilt and 350° rotation

MOUNTING

Surface

APPLICATION AREAS

Indoor, Commercial, Residential, Retail, Hospitality, Galleries

TECHNICAL DATA

LSS04GU1031

LAMP HOLDER	GU10 x1
TOTAL POWER (W)	7.5W max
OPERATING VOLTAGE-VAC	220-240V
DIMENSIONS	D:φ60 x H:98mm

LAMP DATA

LPPAR165036

LAMP	LED
DIMMABLE	YES
BASE	GU10
TOTAL POWER (W)	5.5W
SYSTEM OUTPUT (LM)	380 / 400LM
CCT (K)	3000 / 4000 / 6500K
CRI (Ra)	90
BEAM ANGLE	36°
OPERATING VOLTAGE	220-240V
RATED LIFE (HRS)	25 000HRS
DIMENSIONS	D:φ51 x H:52mm



PLEASE NOTE

Lamp specifications and lamp warranties may differ

E&OE MAY OCCUR

DANNY MINI SGR E1-GU10

GU10 SURFACE SPOT

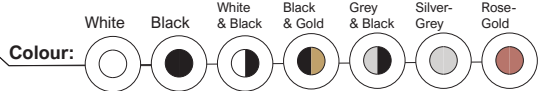
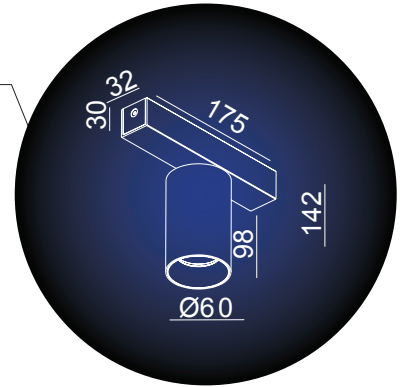
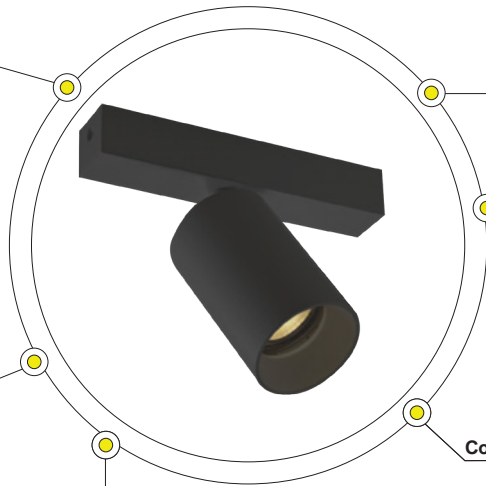

PHYSICAL DATA

FEATURES

- Material: Die-cast aluminium
- Adjustable with spot-head adjust of 90° tilt and 350° rotation

MOUNTING

Surface

APPLICATION AREAS

Indoor, Commercial, Residential, Retail, Hospitality, Galleries



TECHNICAL DATA

LSS03GU1031

LAMP HOLDER	GU10 x1
TOTAL POWER (W)	7.5W max
OPERATING VOLTAGE-VAC	220-240V
DIMENSIONS	D:φ60 x H:98mm

LAMP DATA

LPPAR165036

LAMP	LED
DIMMABLE	YES
BASE	GU10
TOTAL POWER (W)	5.5W
SYSTEM OUTPUT (LM)	380 / 400LM
CCT (K)	3000 / 4000 / 6500K
CRI (Ra)	90
BEAM ANGLE	36°
OPERATING VOLTAGE	220-240V
RATED LIFE (HRS)	25 000HRS
DIMENSIONS	D:φ51 x H:52mm



PLEASE NOTE

Lamp specifications and lamp warranties may differ

E&OE MAY OCCUR

DANNY MINI SGR E2-GU10

GU10 SURFACE SPOT

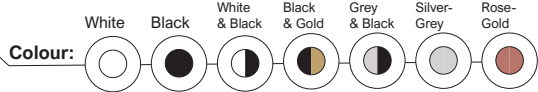
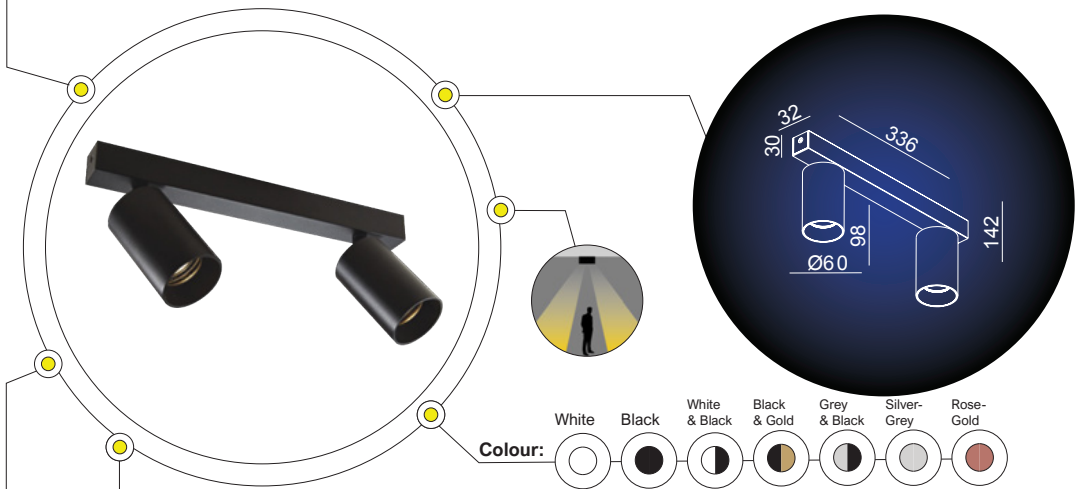

+ IP 20



LOA

3 YRS



PHYSICAL DATA

FEATURES

- Material: Die-cast aluminium
- Twin adjustable with spot-head adjust of 90° tilt and 350° rotation

MOUNTING

Surface

APPLICATION AREAS

Indoor, Commercial, Residential, Retail, Hospitality, Galleries

TECHNICAL DATA

LSS032GU1031

LAMP HOLDER	GU10 x2
TOTAL POWER (W)	7.5W max
OPERATING VOLTAGE-VAC	220-240V
DIMENSIONS	D:φ60 x H:98mm x2

LAMP DATA

LPPAR165036

LAMP	LED
DIMMABLE	YES
BASE	GU10
TOTAL POWER (W)	5.5W
SYSTEM OUTPUT (LM)	380 / 400LM
CCT (K)	3000 / 4000 / 6500K
CRI (Ra)	90
BEAM ANGLE	36°
OPERATING VOLTAGE	220-240V
RATED LIFE (HRS)	25 000HRS
DIMENSIONS	D:φ51 x H:52mm



PLEASE NOTE

Lamp specifications and lamp warranties may differ

E&OE MAY OCCUR

DANNY MINI SGR E3-GU10

GU10 SURFACE SPOT

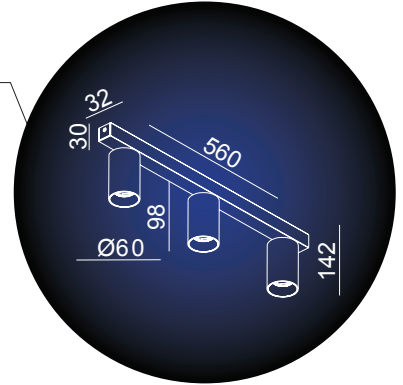
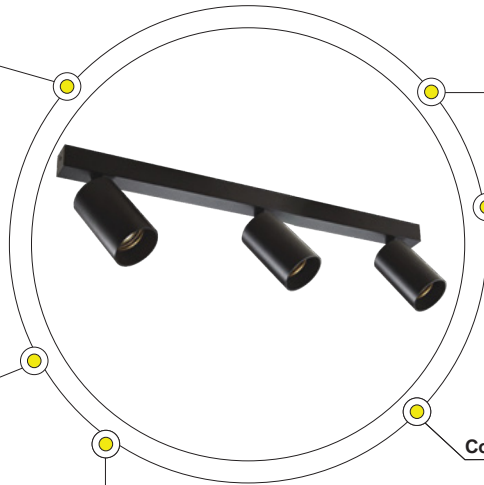

PHYSICAL DATA

FEATURES

- Material: Die-cast aluminium
- Twin adjustable with spot-head adjust of 90° tilt and 350° rotation

MOUNTING

Surface

APPLICATION AREAS

Indoor, Commercial, Residential, Retail, Hospitality, Galleries



TECHNICAL DATA

LSS033GU1031

LAMP HOLDER	GU10 x3
TOTAL POWER (W)	7.5W max
OPERATING VOLTAGE-VAC	220-240V
DIMENSIONS	D:φ60 x H:98mm x3

LAMP DATA

LPPAR165036

LAMP	LED
DIMMABLE	YES
BASE	GU10
TOTAL POWER (W)	5.5W
SYSTEM OUTPUT (LM)	380 / 400LM
CCT (K)	3000 / 4000 / 6500K
CRI (Ra)	90
BEAM ANGLE	36°
OPERATING VOLTAGE	220-240V
RATED LIFE (HRS)	25 000HRS
DIMENSIONS	D:φ51 x H:52mm



PLEASE NOTE

Lamp specifications and lamp warranties may differ

E&OE MAY OCCUR

DANNY SPOT

GU10 SURFACE SPOT

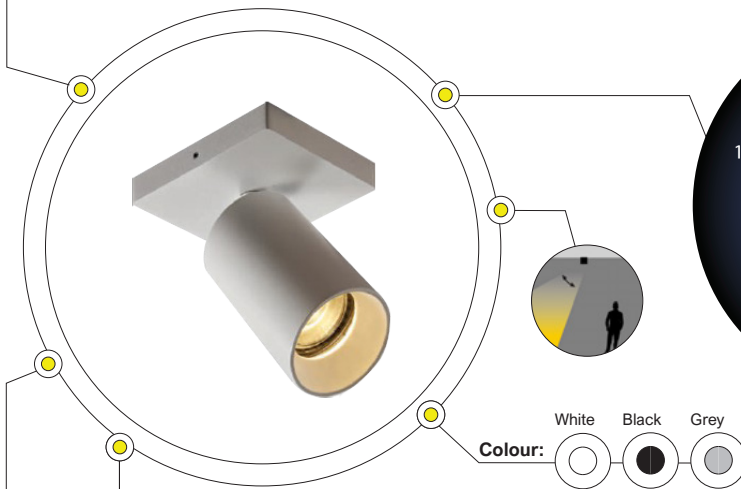

+IP 20



LOA

2 YRS



PHYSICAL DATA

FEATURES

- Material: Die-cast aluminium
- Powder Coated
- Simple lamp installation
- Adjustable with 90° tilt and 355° rotation capability

MOUNTING

Surface

APPLICATION AREAS

Indoor, Commercial, Residential, Retail, Hospitality, Galleries

TECHNICAL DATA

LSS02GU1031

LAMP HOLDER	GU10
TOTAL POWER (W)	7.5W max
OPERATING VOLTAGE-VAC	220-240V
DIMENSIONS	D:φ60 x H:98mm

LAMP DATA

LPPAR165036

LAMP	LED
DIMMABLE	YES
BASE	GU10
TOTAL POWER (W)	5.5W
SYSTEM OUTPUT (LM)	380 / 400LM
CCT (K)	3000 / 4000 / 6500K
CRI (Ra)	90
BEAM ANGLE	36°
OPERATING VOLTAGE	220-240V
RATED LIFE (HRS)	25 000HRS
DIMENSIONS	D:φ51 x H:52mm



PLEASE NOTE

Lamp specifications and lamp warranties may differ

E&OE MAY OCCUR

DANNY SPOT DOUBLE

GU10 SURFACE SPOT

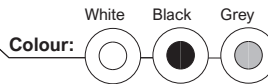
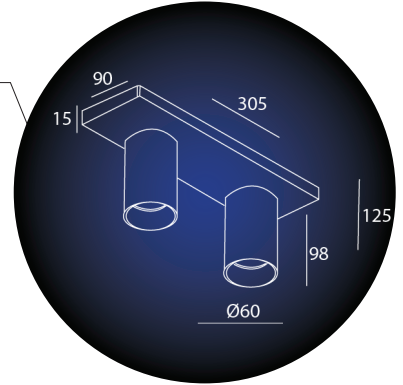
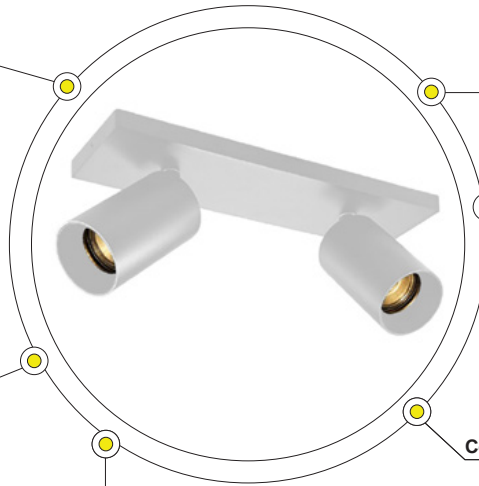

PHYSICAL DATA

FEATURES

- Material: Die-cast aluminium
- Powder Coated
- Simple lamp installation
- Adjustable with 90° tilt and 355° rotation capability

MOUNTING

Surface

APPLICATION AREAS

Indoor, Commercial, Residential, Retail, Hospitality, Galleries



TECHNICAL DATA

LSS022GU1031

LAMP HOLDER	GU10 x2
TOTAL POWER (W)	7.5W max
OPERATING VOLTAGE-VAC	220-240V
DIMENSIONS	D:φ60 x H:98mm x 2

LAMP DATA

LPPAR165036

LAMP	LED
DIMMABLE	YES
BASE	GU10
TOTAL POWER (W)	5.5W
SYSTEM OUTPUT (LM)	380 / 400LM
CCT (K)	3000 / 4000 / 6500K
CRI (Ra)	90
BEAM ANGLE	36°
OPERATING VOLTAGE	220-240V
RATED LIFE (HRS)	25 000HRS
DIMENSIONS	D:φ51 x H:52mm



PLEASE NOTE

Lamp specifications and lamp warranties may differ

E&OE MAY OCCUR

DANNY SPOT TRIPLE

GU10 SURFACE SPOT

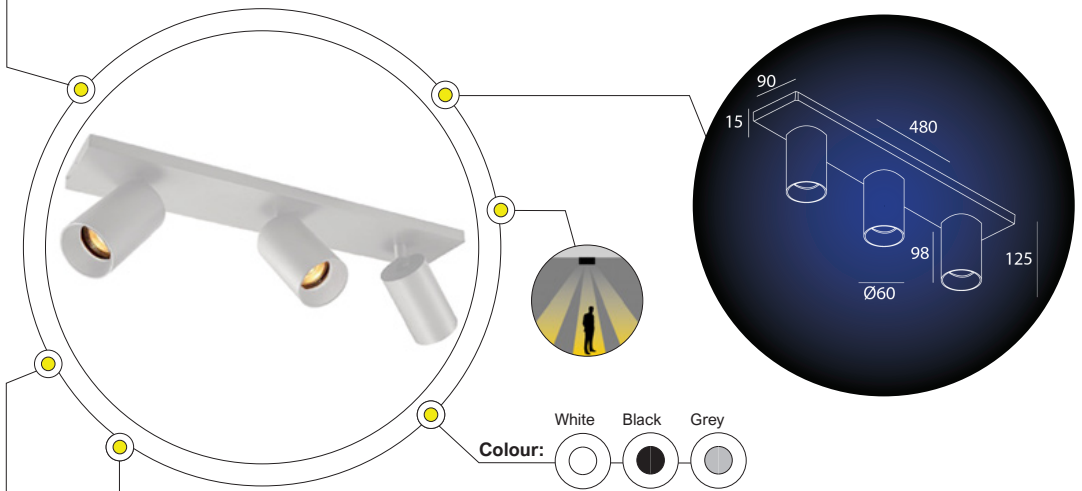

+IP 20



LOA

2 YRS



PHYSICAL DATA

FEATURES

- Material: Die-cast aluminium
- Powder Coated
- Simple lamp installation
- Adjustable with 90° tilt and 355° rotation capability

MOUNTING

Surface

APPLICATION AREAS

Indoor, Commercial, Residential, Retail, Hospitality, Galleries

TECHNICAL DATA

LSS023GU1031

LAMP HOLDER	GU10 x3
TOTAL POWER (W)	7.5W max
OPERATING VOLTAGE-VAC	220-240V
DIMENSIONS	D:φ60 x H:98mm x3

LAMP DATA

LPPAR165036

LAMP	LED
DIMMABLE	YES
BASE	GU10
TOTAL POWER (W)	5.5W
SYSTEM OUTPUT (LM)	380 / 400LM
CCT (K)	3000 / 4000 / 6500K
CRI (Ra)	90
BEAM ANGLE	36°
OPERATING VOLTAGE	220-240V
RATED LIFE (HRS)	25 000HRS
DIMENSIONS	D:φ51 x H:52mm



PLEASE NOTE

Lamp specifications and lamp warranties may differ

E&OE MAY OCCUR

> DOWNLIGHTS - SURFACE

COMMERCIAL & ARCHITECTURAL



MOONY S

SURFACE DOWNLIGHT

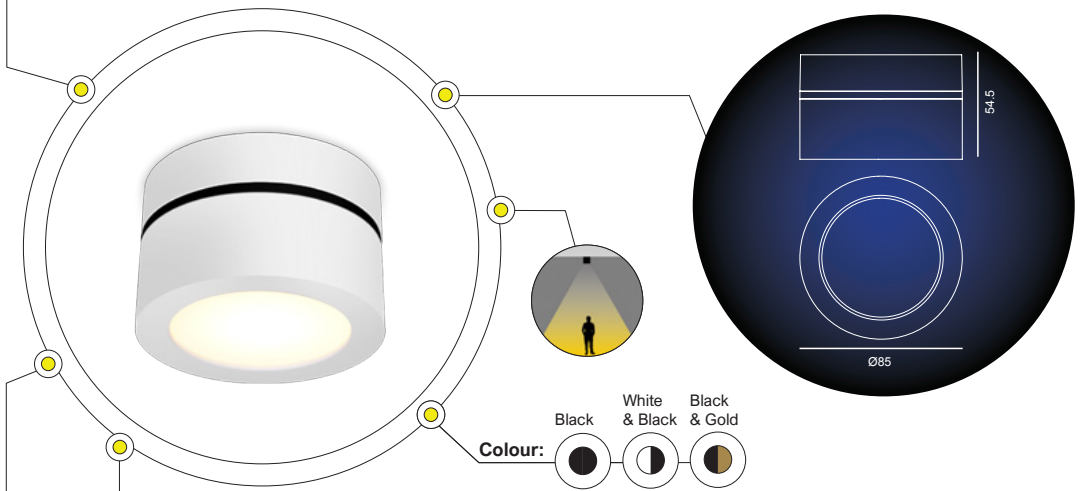

+ IP 54



LOA

3 YRS

ldt

PHYSICAL DATA

FEATURES

- Material: Aluminium
- The MOONY is a classical surface mounted series that is extremely versatile and can be used in both interior or exterior applications
- Simple minimalistic design
- Ideal for emphasis lighting
- TRIAC Dimmable

OPTIONS & ACCESSORIES

- Moony S Spot with 37° beam option available

MOUNTING

Surface

APPLICATION AREAS

Indoor, Commercial, Residential, Retail, Hospitality

TECHNICAL DATA

LF213514EDT

LAMP	LED
TOTAL POWER (W)	6.4W
SYSTEM OUTPUT (LM)	225LM
CCT (K)	2700 / 3000 / 4000K
CRI (Ra)	90
BEAM ANGLE	180°
OPERATING VOLTAGE-VAC	220-240V
SOURCE POWER (W)	30-100%
FLICKER FACTOR	100HZ/0.26%
WEIGHT (KG)	0.3KG
DIMENSIONS	D:φ85 x H:54.5mm

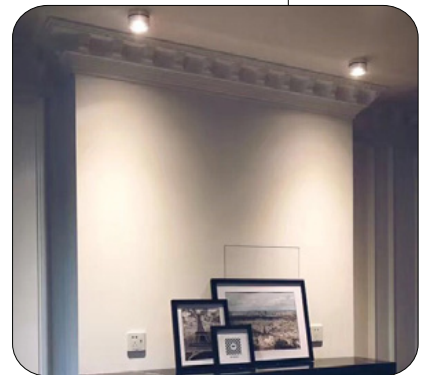

- CD / KLM
- C0 - C180
 - C90 - C270

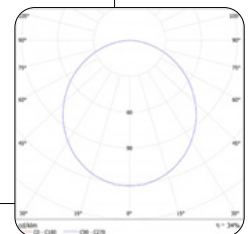

E&OE MAY OCCUR

MOONY S SPOT

SURFACE DOWNLIGHT

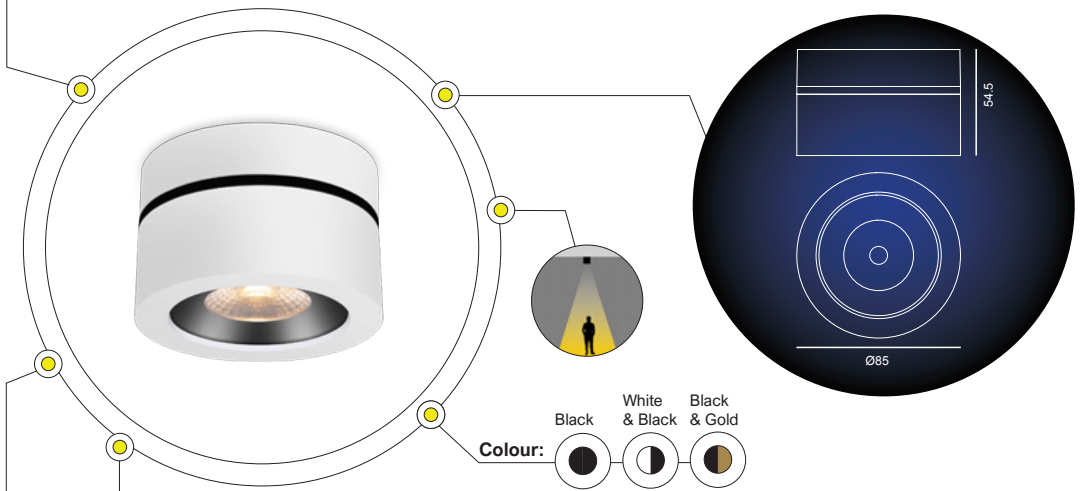

PHYSICAL DATA

FEATURES

- Material: Aluminium
- The MOONY is a classical surface mounted series that is extremely versatile and can be used in both interior or exterior applications
- Simple minimalistic design
- TRIAC Dimmable

OPTIONS & ACCESSORIES

- Moony S with diffused light option available

MOUNTING

Surface

APPLICATION AREAS

Indoor, Commercial, Residential, Retail, Hospitality

+ IP 54



LOA

3 YRS

ldt

TECHNICAL DATA

LF213414EDT

LAMP	LED
TOTAL POWER (W)	6.4W
SYSTEM OUTPUT (LM)	499LM
CCT (K)	2700 / 3000 / 4000K
CRI (Ra)	90
BEAM ANGLE	37°
OPERATING VOLTAGE-VAC	220-240V
DIMMING RANGE	30-100%
SOURCE POWER (W)	6.4W
FLICKER FACTOR	99.83HZ/1.63%
WEIGHT (KG)	0.35KG
DIMENSIONS	D:φ85 x H:54.5mm

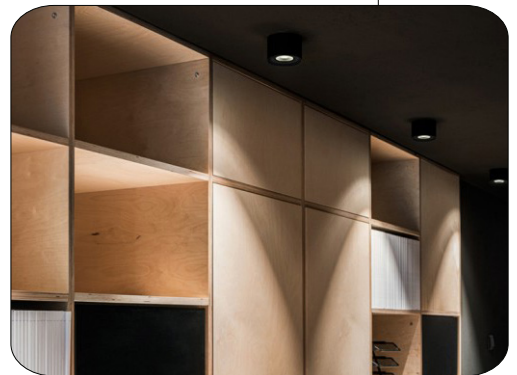

- CD / KLM
- C0 - C180
 - C90 - C270

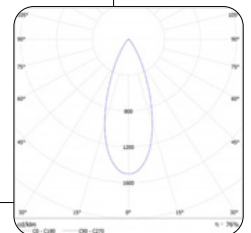

E&OE MAY OCCUR

MOONY M

SURFACE DOWNLIGHT

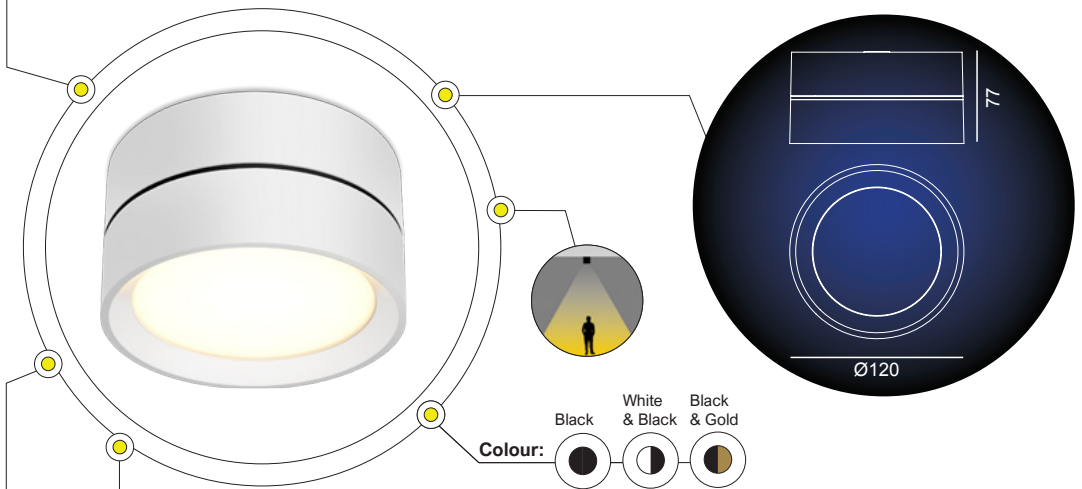

+ IP 54



LOA

3 YRS

ldt

PHYSICAL DATA

FEATURES

- Material: Aluminium
- The MOONY is a classical surface mounted series that is extremely versatile and can be used in both interior or exterior applications
- Simple minimalistic design
- Diffused lighting effect
- Low flicker

OPTIONS & ACCESSORIES

- TRIAC Dimmable option available
- Moony M Spot with narrower beam option available

MOUNTING

Surface

APPLICATION AREAS

Indoor, Commercial, Residential, Retail, Hospitality

TECHNICAL DATA

LF202017A

LAMP	LED
TOTAL POWER (W)	13.61W
SYSTEM OUTPUT (LM)	690LM
CCT (K)	2700 / 3000 / 4000K
CRI (Ra)	80
BEAM ANGLE	180°
OPERATING VOLTAGE-VAC	220-240V
SOURCE POWER (W)	11.6W
FLICKER FACTOR	99.83HZ/1.63%
WEIGHT (KG)	0.79KG
DIMENSIONS	D:φ120 x H:77mm



- CD / KLM
- C0 - C180
 - C90 - C270

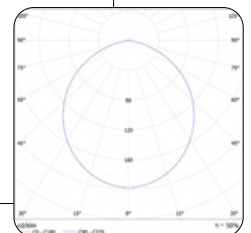

E&OE MAY OCCUR

MOONY M SPOT

SURFACE DOWNLIGHT

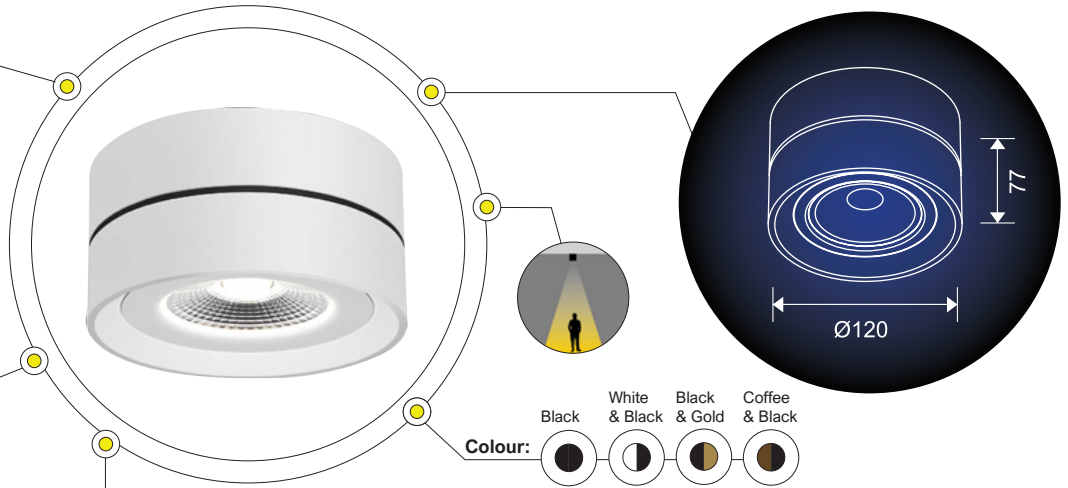

PHYSICAL DATA

FEATURES

- Material: Aluminium
- The MOONY is a classical surface mounted series that is extremely versatile and can be used in both interior or exterior applications
- Simple minimalistic design
- Low flicker
- TRIAC Dimmable

OPTIONS & ACCESSORIES

- Moony M with diffused light option available

MOUNTING

Surface

APPLICATION AREAS

Indoor, Commercial, Residential, Retail, Hospitality

+ IP 54



LOA

5 YRS

ldt

TECHNICAL DATA

LF208415DT

LAMP	LED
TOTAL POWER (W)	20.44W
SYSTEM OUTPUT (LM)	1624LM
CCT (K)	2700 / 3000 / 4000K
CRI (Ra)	80
BEAM ANGLE	38°
OPERATING VOLTAGE-VAC	220-240V
DIMMING RANGE	30-100%
SOURCE POWER (W)	17.4W
WEIGHT (KG)	0.71KG
DIMENSIONS	D:φ120 x H:77mm



- CD / KLM
- C0 - C180
 - C90 - C270

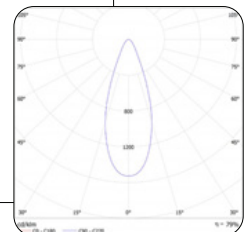

E&OE MAY OCCUR

PEBUK M

SURFACE DOWNLIGHTS

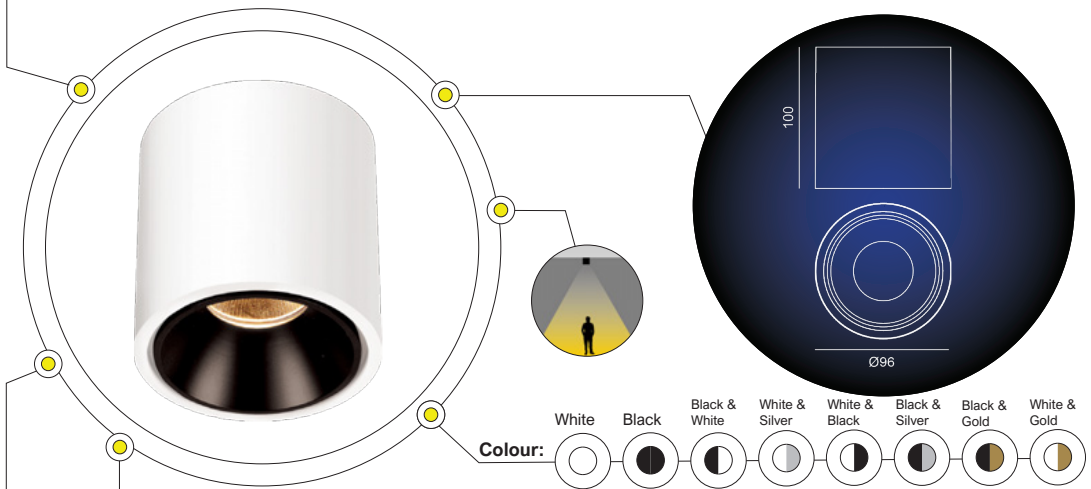

+ IP 54



LOA

5 YRS

ldt

PHYSICAL DATA

FEATURES

- Material: Aluminium
- The PEBUK offers a simple streamlined design with an array of colours to choose from; ideal for any interior
- The PEBUK gives a soft and harmonious lighting effect and is anti-glare
- TRIAC Dimmable

- Turnable White App Dim function option available

MOUNTING

Surface

APPLICATION AREAS

Indoor, Commercial, Residential, Retail, Hospitality

OPTIONS & ACCESSORIES

TECHNICAL DATA

LF210212EDT

LAMP	LED
TOTAL POWER (W)	15.6W
SYSTEM OUTPUT (LM)	1087LM
CCT (K)	2700 / 3000 / 4000K
CRI (Ra)	90
BEAM ANGLE	36° / 46°
OPERATING VOLTAGE-VAC	220-240V
SOURCE POWER (W)	18.3W
SOURCE OUTPUT (LM)	1758LM
CURRENT (MA)	700MA
DIMMING RANGE	30-100%
FLICKER FACTOR	107.33HZ / 1.4%
WEIGHT (KG)	0.61KG
DIMENSIONS	D:φ96 x H:100mm



- CD / KLM
- C0 - C180
 - C90 - C270

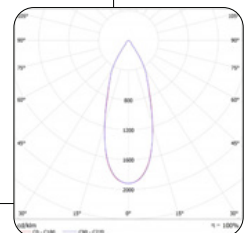

E&OE MAY OCCUR

LSD01

SURFACE DOWNLIGHT

DOWNLIGHTS – SURFACE – LSD01

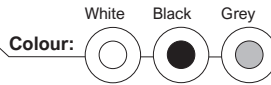
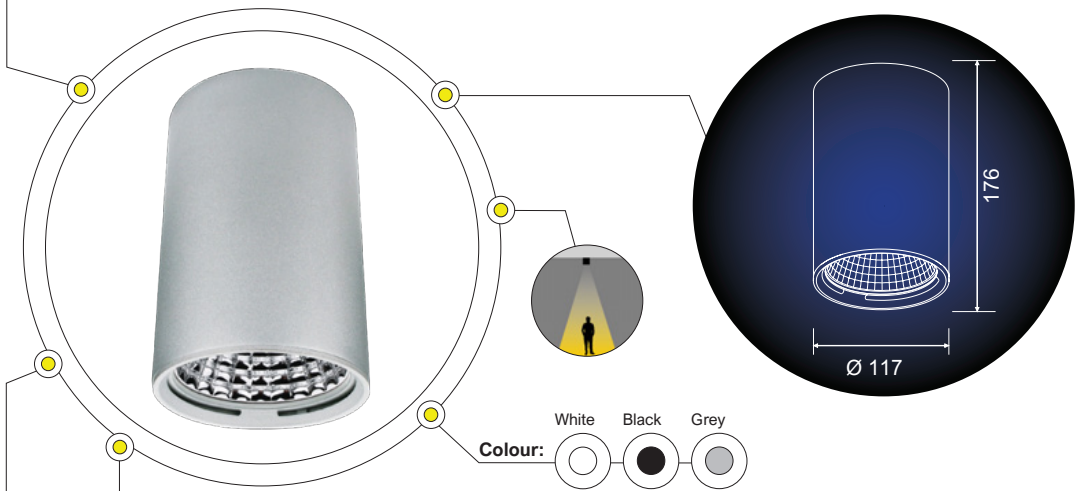

+ IP 20



LOA



PHYSICAL DATA

FEATURES

- Material: ALuminium
- Heatsink and driver integrated in the housing of luminaire

- Lens options available
- Pendant option available

MOUNTING

Surface

OPTIONS & ACCESSORIES

- TRIAC, 0-10V, Dali dimming options available
- Special CCT available for meat, bread, fish, vegetables and clothing available

APPLICATION AREAS

Indoor, Commercial, Residential, Retail, Hospitality

TECHNICAL DATA

LSD0117

LSD0125

LAMP	LED	LED
TOTAL POWER (W)	17W	25W
SYSTEM OUTPUT (LM)	1974 / 2245LM	2867 / 2970LM
EFFICACY (LM/W)	95 / 108	97 / 99
CCT (K)	3500 / 4000K	3500 / 4000K
CRI (Ra)	80	80
BEAM ANGLE	15° / 24° / 44° / 59°	15° / 24° / 44° / 59°
RATED LIFE (HRS)	50 000 HRS	50 000 HRS
OPERATING VOLTAGE-VAC	220-240V	220-240V
CURRENT (MA)	500MA	700MA
SOURCE POWER (W)	20W	30W
SOURCE OUTPUT (LM)	2448 / 2479LM	3417 / 3426LM
ILLUM @ 1M (LUX)	10401 / 11743LX	15413 / 15892LX
FLICKER FACTOR	<4%	<4%
OPERATING TEMP °C	-20°C TO 50°C	-20°C TO 50°C
POWER FACTOR	≥0.9	≥0.9
R9 VALUE	11	12
UGR	<15	<15
MAC ADAM STEP	3SDCM	3SDCM
DIMENSIONS	D:117 x H:176mm	D:117 x H:176mm

CD / KLM

- C0 - C180
- C90 - C270

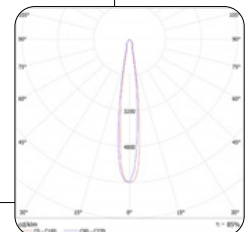

E&OE MAY OCCUR

> DOWNLIGHTS - SURFACE

GU10



LSD05

GU10 LED SURFACE
DOWNLIGHT

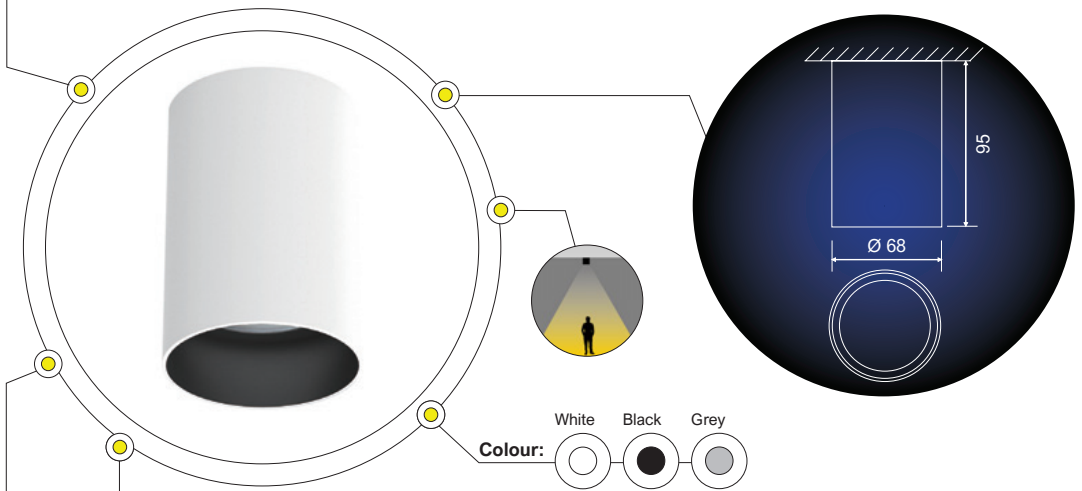

PHYSICAL DATA

FEATURES

- Material: Aluminium
- Extruded aluminium housing with no external screws
- Electrostatic powder coating
- Simple lamp installation

MOUNTING

Surface

APPLICATION AREAS

Indoor, Commercial, Residential, Retail, Hospitality



TECHNICAL DATA

LSD05

LAMP HOLDER	GU10
VOLTAGE	230V 50Hz
DIMENSIONS	D:φ68 x H:95mm

LAMP DATA

LPPAR165036

LAMP	LED
DIMMABLE	YES
BASE	GU10
TOTAL POWER (W)	5.5W
SYSTEM OUTPUT (LM)	380 / 400LM
CCT (K)	3000 / 4000 / 6500K
CRI (Ra)	90
BEAM ANGLE	36°
OPERATING VOLTAGE	220-240V
RATED LIFE (HRS)	25 000HRS
DIMENSIONS	D:φ51 x H:52mm



PLEASE NOTE

Lamp specifications and lamp warranties may differ

E&OE MAY OCCUR

LSD06

GU10 LED SURFACE DOWNLIGHT

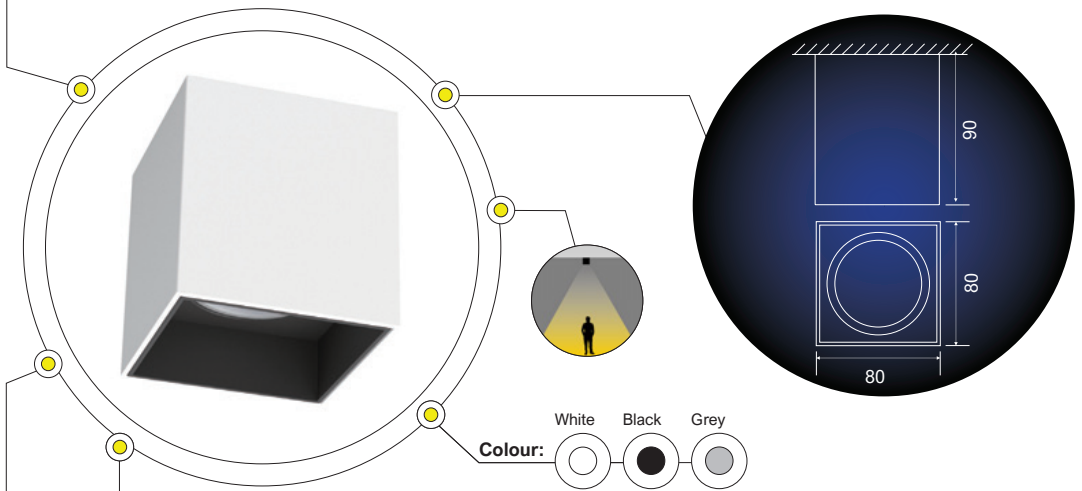

+IP 20



LOA

3 YRS



PHYSICAL DATA

FEATURES

- Material: Aluminium
- Extruded aluminium housing with no external screws
- Electrostatic powder coating
- Simple lamp installation

MOUNTING

Surface

APPLICATION AREAS

Indoor, Commercial, Residential, Retail, Hospitality

TECHNICAL DATA

LSD06

LAMP HOLDER	GU10
VOLTAGE	230V 50Hz
DIMENSIONS	L:80 x W:80 x H:90mm

LAMP DATA

LPPAR165036

LAMP	LED
DIMMABLE	YES
BASE	GU10
TOTAL POWER (W)	5.5W
SYSTEM OUTPUT (LM)	380 / 400LM
CCT (K)	3000 / 4000 / 6500K
CRI (Ra)	90
BEAM ANGLE	36°
OPERATING VOLTAGE	220-240V
RATED LIFE (HRS)	25 000HRS
DIMENSIONS	D:φ51 x H:52mm



PLEASE NOTE

Lamp specifications and lamp warranties may differ

LSD062

GU10 LED SURFACE
DOWNLIGHT

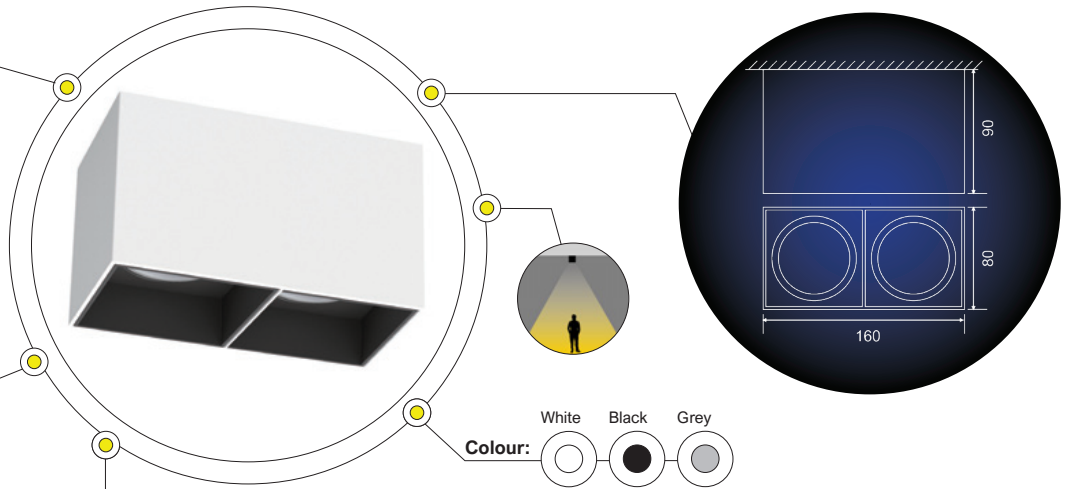

PHYSICAL DATA

FEATURES

- Material: Aluminium
- Extruded aluminium housing with no external screws
- Electrostatic powder coating
- Simple lamp installation

MOUNTING

Surface

APPLICATION AREAS

Indoor, Commercial, Residential, Retail, Hospitality



TECHNICAL DATA

LSD062

LAMP HOLDER	GU10 x 2
VOLTAGE	230V 50Hz
DIMENSIONS	L:160 x W:80 x H:90mm

LAMP DATA

LPPAR165036

LAMP	LED
DIMMABLE	YES
BASE	GU10
TOTAL POWER (W)	5.5W
SYSTEM OUTPUT (LM)	380 / 400LM
CCT (K)	3000 / 4000 / 6500K
CRI (Ra)	90
BEAM ANGLE	36°
OPERATING VOLTAGE	220-240V
RATED LIFE (HRS)	25 000HRS
DIMENSIONS	D:φ51 x H:52mm



PLEASE NOTE

Lamp specifications and lamp warranties may differ

E&OE MAY OCCUR

> DOWNLIGHTS – RECESSED

COMMERCIAL



DOWNLIGHTS – RECESSED – COMMERCIAL

Project H&M Waterfront / Photography: Archigraphy

LRD01

LED RECESSED
DOWNLIGHT

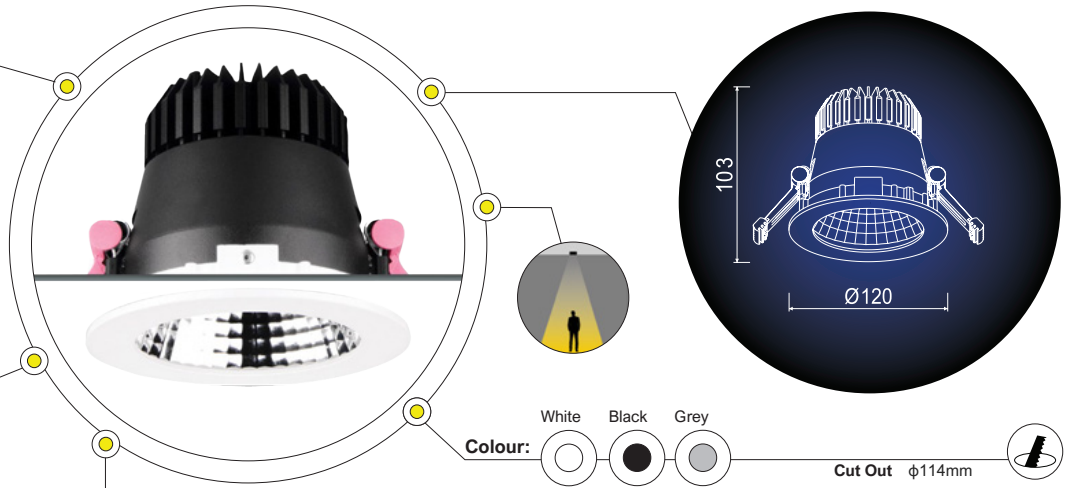

+ IP 20



LOA

5 YRS

ldt



PHYSICAL DATA

FEATURES

- Material: Die-cast aluminium housing / trim ring
- Powder coated trim ring

MOUNTING

Recessed

OPTIONS & ACCESSORIES

- TRIAC, 0-10V and DALI Dimming available
- Glass accessory available
- EMG pack available

APPLICATION AREAS

Indoor, Commercial, Retail, Hospitality, Public Buildings

TECHNICAL DATA

	LRD0117	LRD0125	LRD0133
LAMP	LED	LED	LED
TOTAL POWER (W)	17W	25W	33W
SYSTEM OUTPUT (LM)	1634 / 1592LM	2321 / 2407LM	2713 / 2834LM
EFFICACY (LM/W)	85 / 76	80	75 / 76
CCT (K)	3500 / 4000K	3500 / 4000K	3500 / 4000K
CRI (Ra)	80	80	80
BEAM ANGLE	24° / 39°	24° / 39°	24° / 39°
OPERATING VOLTAGE-VAC	220-240V	220-240V	220-240V
SOURCE POWER (W)	20W	30W	40W
LIGHT OUTPUT (LM)	2236 / 1939LM	3417 / 3426LM	4132 / 4048LM
CURRENT (MA)	500MA	700MA	900MA
RATED LIFE (HRS)	50 000 HRS	50 000 HRS	50 000 HRS
ILLUM @ 1M (LUX)	5844 / 3831LX	8329 / 5767LX	9717 / 6782LX
FLICKER FACTOR	<4%	<4%	<4%
POWER FACTOR	≥0.9	≥0.9	≥0.9
R9 VALUE	11	12	12
UGR	<22	<22	<22
MAC ADAM STEP	3SDCM	3SDCM	3SDCM
OPERATING TEMP °C	-20°C TO 50°C	-20°C TO 50°C	-20°C TO 50°C
DIMENSIONS	D:φ120 x H:103mm	D:φ120 x H:103mm	D:φ120 x H:103mm
CUT OUT	D:φ114mm	D:φ114mm	D:φ114mm

CD / KLM

● C0 - C180

● C90 - C270

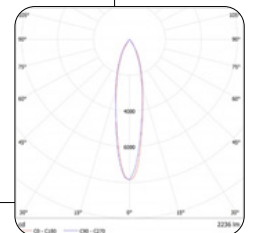

E&OE MAY OCCUR

LRD02

LED RECESSED DOWNLIGHT

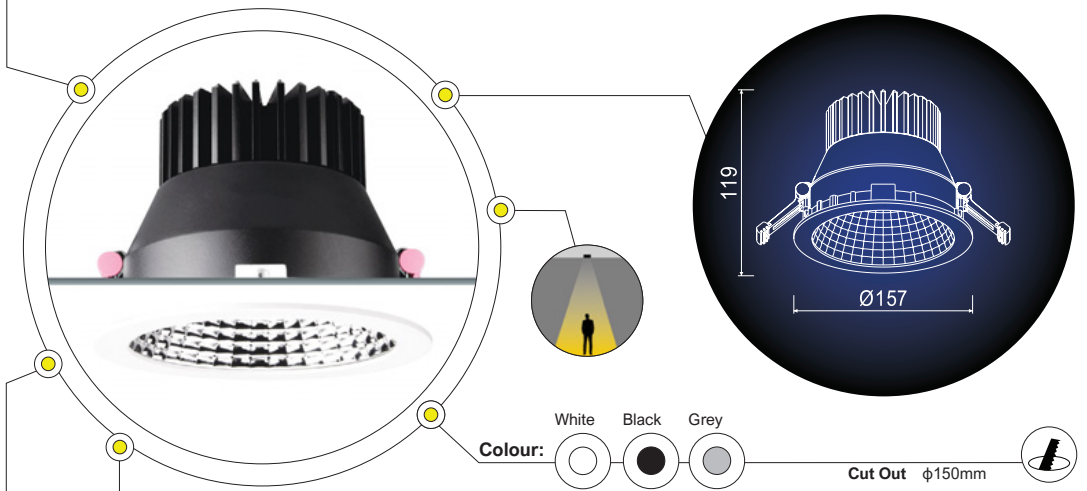

+ IP 20



LOA

5 YRS

ldt



PHYSICAL DATA

FEATURES

- Material: Die-cast aluminium housing / trim ring
- Powder coated trim ring
- Higher reflective efficiency with the Alanrod Miro material

- EMG pack available
- Special CCT available for meat, bread, fish, vegetables and clothing

OPTIONS & ACCESSORIES

- TRIAC, 0-10V and DALI Dimming available
- Glass accessory available

MOUNTING

Recessed

APPLICATION AREAS

Indoor, Commercial, Retail, Hospitality, Public Buildings

TECHNICAL DATA

	LRD0217	LRD0225	LRD0233
LAMP	LED	LED	LED
TOTAL POWER (W)	17W	25W	33W
SYSTEM OUTPUT (LM)	1749 / 1932LM	2593 / 2652LM	3063 / 3173LM
EFFICACY (LM/W)	90 / 93	89	85 / 84
CCT (K)	3500 / 4000K	3500 / 4000K	3500 / 4000K
CRI (Ra)	80	80	80
BEAM ANGLE	24° / 42° / 64°	24° / 42° / 64°	24° / 42° / 64°
OPERATING VOLTAGE-VAC	220-240V	220-240V	220-240V
SOURCE POWER (W)	20W	29W	36W
LIGHT OUTPUT (LM)	2236 / 2430LM	3417 / 3426LM	4132 / 4048LM
CURRENT (MA)	500MA	700MA	900MA
RATED LIFE (HRS)	50 000 HRS	50 000 HRS	50 000 HRS
ILLUM @ 1M (LUX)	3238 / 2399LX	4799 / 3293LX	5652 / 3937LX
FLICKER FACTOR	<4%	<4%	<4%
POWER FACTOR	≥0.9	≥0.9	≥0.9
R9 VALUE	11	12	12
UGR	<18	<18	<18
MAC ADAM STEP	3SDCM	3SDCM	3SDCM
OPERATING TEMP °C	-20°C TO 50°C	-20°C TO 50°C	-20°C TO 50°C
DIMENSIONS	D:φ157 x H:119mm	D:φ157 x H:119mm	D:φ157 x H:119mm
CUT OUT	D:φ150mm	D:φ150mm	D:φ150mm

CD / KLM

- C0 - C180
- C90 - C270

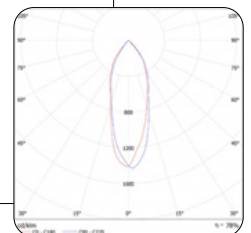

E&OE MAY OCCUR

LRD03

LED RECESSED DOWNLIGHT

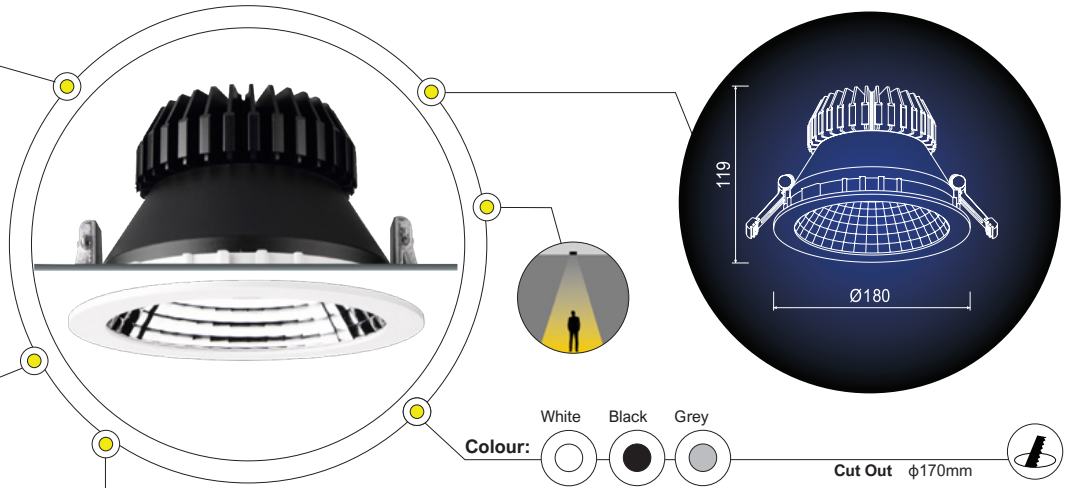

PHYSICAL DATA

FEATURES

- Material: Aluminium / Polycarbonate
- Powder coated trim ring
- Higher reflective efficiency with the Alanrod Miro material

- Other CCT (K) available

MOUNTING

Recessed

APPLICATION AREAS

Indoor, Commercial, Retail, Hospitality, Public Buildings

OPTIONS & ACCESSORIES

- TRIAC, 0-10V and DALI Dimming available
- Glass accessory available

TECHNICAL DATA

	LRD0317	LRD0325	LRD0333
LAMP	LED	LED	LED
TOTAL POWER (W)	17W	25W	33W
SYSTEM OUTPUT (LM)	1984 / 2064LM	2697 / 2855LM	3306 / 3421LM
EFFICACY (LM/W)	95 / 99	91 / 95	89 / 90
CCT (K)	3500 / 4000K	3500 / 4000K	3500 / 4000K
CRI (Ra)	80	80	80
BEAM ANGLE	60°	60°	60°
OPERATING VOLTAGE-VAC	220-240V	220-240V	220-240V
SOURCE POWER (W)	20W	30W	36W
LIGHT OUTPUT (LM)	2433 / 2430LM	3390 / 3426LM	4098 / 4048LM
CURRENT (MA)	500MA	700MA	900MA
RATED LIFE (HRS)	50 000 HRS	50 000 HRS	50 000 HRS
ILLUM @ 1M (LUX)	3238 / 1148LX	2513 / 1587LX	3346 / 1901LX
FLICKER FACTOR	<4%	<4%	<4%
POWER FACTOR	≥0.9	≥0.9	≥0.9
R9 VALUE	11	12	12
UGR	<17	<17	<17
MAC ADAM STEP	3SDCM	3SDCM	3SDCM
OPERATING TEMP °C	-20°C TO 50°C	-20°C TO 50°C	-20°C TO 50°C
DIMENSIONS	D:φ180 x H:119mm	D:φ180 x H:119mm	D:φ180 x H:119mm
CUT OUT	D:φ170mm	D:φ170mm	D:φ170mm

CD / KLM

- C0 - C180
- C90 - C270

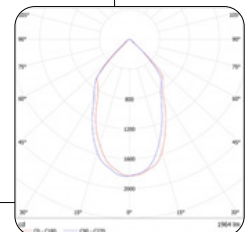

E&OE MAY OCCUR

LRD04

LED RECESSED
DOWNLIGHT

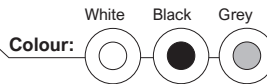
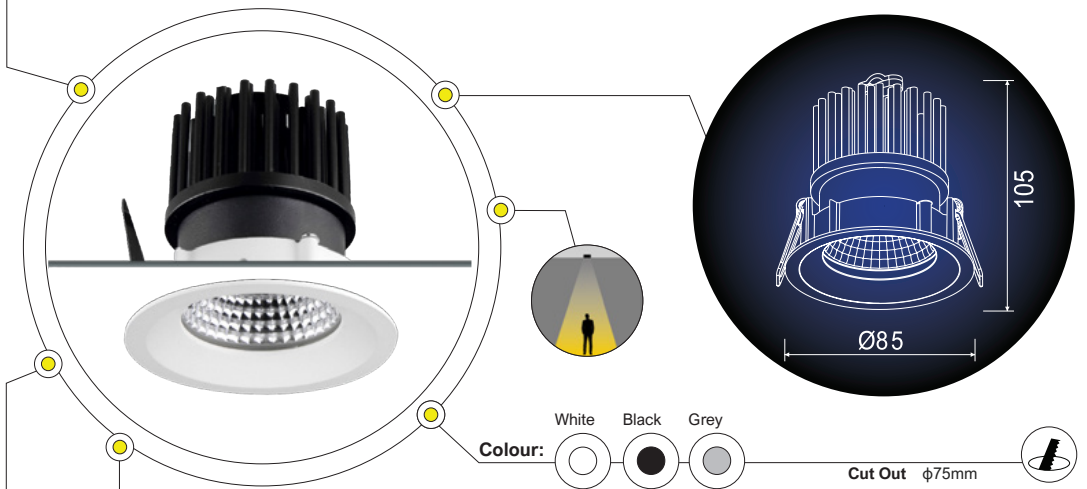

Cut Out ϕ 75mm



+ IP 20



LOA

5 YRS

ldt



PHYSICAL DATA

FEATURES

- Material: Aluminium and Polycarbonate
- Powder coated trim ring
- Higher reflective efficiency with the Alanrod Miro material

- EMG pack available
- Special CCT available for meat, bread, fish, vegetables and clothing

OPTIONS & ACCESSORIES

- TRIAC, 0-10V and DALI Dimming available
- Glass accessory available

MOUNTING

Recessed

APPLICATION AREAS

Indoor, Commercial, Retail, Hospitality, Public Buildings

TECHNICAL DATA

	LRD0406	LRD0412
LAMP	LED	LED
TOTAL POWER (W)	6W	12W
SYSTEM OUTPUT (LM)	629 / 594LM	1083 / 1694LM
EFFICACY (LM/W)	70	71 / 72
CCT (K)	3500 / 4000K	3500 / 4000K
CRI (Ra)	80	80
BEAM ANGLE	28° / 53°	28° / 53°
OPERATING VOLTAGE-VAC	220-240V	220-240V
SOURCE POWER (W)	7W	15W
LIGHT OUTPUT (LM)	915 / 961LM	1635 / 1652LM
CURRENT (MA)	200MA	350MA
RATED LIFE (HRS)	50 000 HRS	50 000 HRS
ILLUM @ 1M (LUX)	802 / 713LX	1367 / 1317LX
FLICKER FACTOR	<4%	<4%
POWER FACTOR	≥0.9	≥0.9
R9 VALUE	11	12
UGR	<22	<22
MAC ADAM STEP	3SDCM	3SDCM
OPERATING TEMP °C	-20°C TO 50°C	-20°C TO 50°C
DIMENSIONS	D:φ85 x H:105mm	D:φ85 x H:105mm
CUT OUT	D:φ75mm	D:φ75mm

CD / KLM

- C0 - C180
- C90 - C270

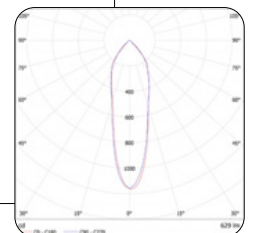

E&OE MAY OCCUR

LRD05

LED RECESSED
DOWNLIGHT

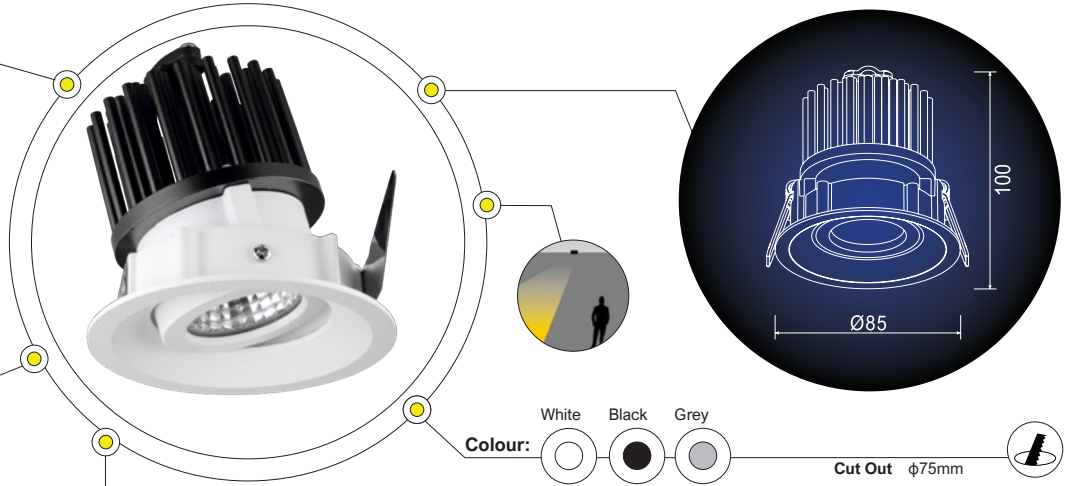

PHYSICAL DATA

FEATURES

- Material: Aluminium and Polycarbonate
- Powder coated trim ring
- Higher reflective efficiency with the Alanrod Miro material
- Adjustable

- Glass accessory available

MOUNTING

Recessed

APPLICATION AREAS

Indoor, Commercial, Retail, Hospitality, Public Buildings

OPTIONS & ACCESSORIES

- TRIAC, 0-10V and DALI Dimming available

TECHNICAL DATA

	LRD0506	LRD0512
LAMP	LED	LED
TOTAL POWER (W)	6W	12W
SYSTEM OUTPUT (LM)	651LM	1195LM
EFFICACY (LM/W)	78 / 77	72 / 79
CCT (K)	3000 / 3500 / 4000K	3000 / 3500 / 4000K
CRI (Ra)	80	80
BEAM ANGLE	20° / 35°	20° / 35°
OPERATING VOLTAGE-VAC	220-240V	220-240V
SOURCE POWER (W)	7W	15W
LIGHT OUTPUT (LM)	915 / 961LM	1635 / 1652LM
CURRENT (MA)	200MA	350MA
RATED LIFE (HRS)	50 000 HRS	50 000 HRS
ILLUM @ 1M (LUX)	1700 / 1584LX	2532 / 2815LX
FLICKER FACTOR	<4%	<4%
POWER FACTOR	≥0.9	≥0.9
R9 VALUE	11	12
UGR	<22	<22
MAC ADAM STEP	3SDCM	3SDCM
OPERATING TEMP °C	-20°C TO 50°C	-20°C TO 50°C
DIMENSIONS	D:φ85 x H:100mm	D:φ85 x H:100mm
CUT OUT	D:φ75mm	D:φ75mm

CD / KLM

- C0 - C180
- C90 - C270

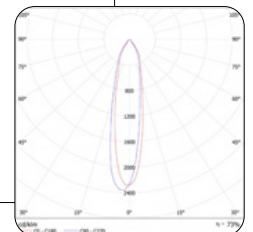

E&OE MAY OCCUR

LRD09

LED RECESSED DOWNLIGHT

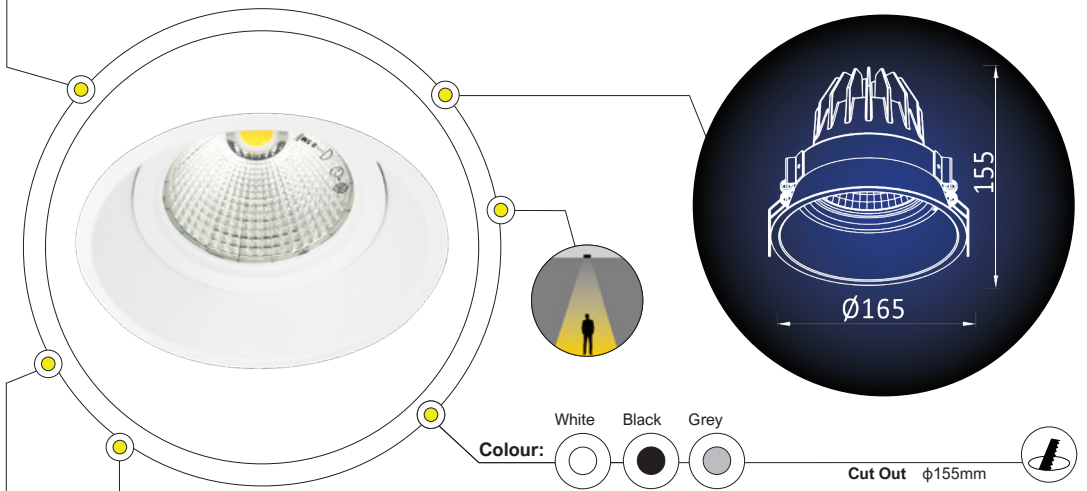

+ IP 20



LOA

5 YRS

ldt



PHYSICAL DATA

FEATURES

- Material: Aluminium
- Designed with the narrowest trim making it as close to trimless as possible but without the install difficulty of trimless
- Higher reflective efficiency with the Alanrod Miro material

- Special CCT available for meat, bread, fish, vegetables and clothing
- Flex and plug or direct connection options available
- TRIAC, 0-10V, Dali dimming options available

MOUNTING: Recessed

APPLICATION AREAS:

Indoor, Commercial, Retail, Hospitality, Public Buildings

OPTIONS & ACCESSORIES

- CRI82, CRI93 and CRI97 available

TECHNICAL DATA

	LRD0917	LRD925	LRD0933
LAMP	LED	LED	LED
TOTAL POWER (W)	17W	25W	33W
SYSTEM OUTPUT (LM)	1681 / 1788LM	2519 / 2724LM	3020 / 3266LM
EFFICACY (LM/W)	83 / 86	85 / 90	80 / 86
CCT (K)	3000 / 3500 / 4000K	3000 / 3500 / 4000K	3000 / 3500 / 4000K
CRI (Ra)	80	80	80
BEAM ANGLE	10° / 23° / 40° / 60°	10° / 24° / 31° / 60°	10° / 24° / 31° / 60°
OPERATING VOLTAGE-VAC	220-240V	220-240V	220-240V
SOURCE POWER (W)	20W	30W	36W
LIGHT OUTPUT (LM)	2443 / 2430LM	3390 / 3426LM	4098 / 4048LM
CURRENT (MA)	500MA	700MA	900MA
RATED LIFE (HRS)	50 000 HRS	50 000 HRS	50 000 HRS
ILLUM @ 1M (LUX)	2413 / 2790LX	3726 / 4229LX	4471 / 5030LX
FLICKER FACTOR	<4%	<4%	<4%
POWER FACTOR	≥0.9	≥0.9	≥0.9
R9 VALUE	11	12	12
UGR	<15	<15	<15
MAC ADAM STEP	3SDCM	3SDCM	3SDCM
OPERATING TEMP °C	-20°C TO 50°C	-20°C TO 50°C	-20°C TO 50°C
DIMENSIONS	D:φ165 x H:155mm	D:φ165 x H:155mm	D:φ165 x H:155mm
CUT OUT	D:φ155mm	D:φ155mm	D:φ155mm

CD / KLM

- C0 - C180
- C90 - C270

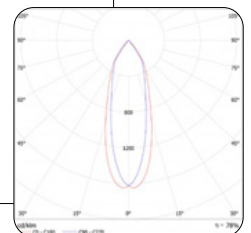

E&OE MAY OCCUR

LRD10

LED RECESSED
DOWNLIGHT

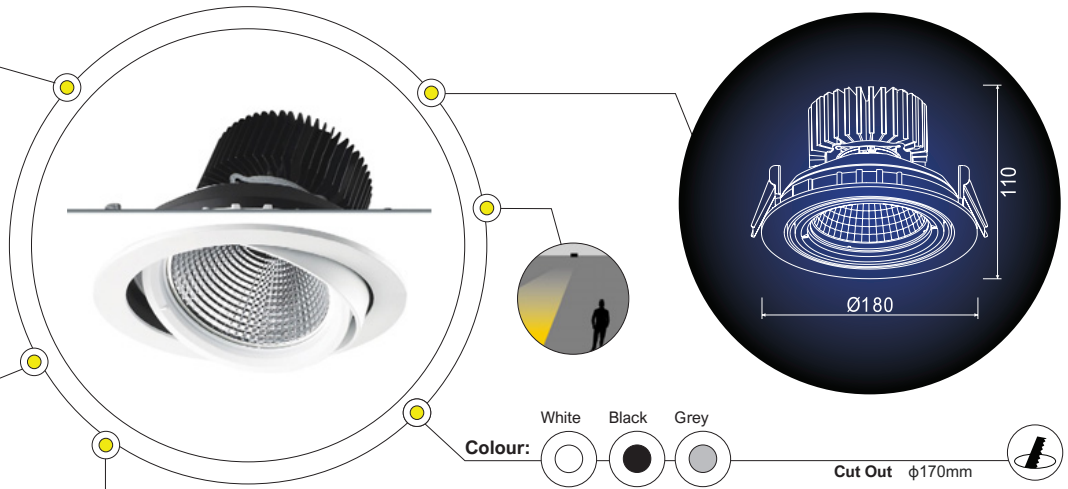

+ IP
20



LOA

5 YRS

ldt



30°

PHYSICAL DATA

FEATURES

- Material: Aluminium
- Powder coated trim ring
- Higher reflective efficiency with the Alanrod Miro material
- Adjustable

- Glass accessory available
- TRIAC, 0-10V, Dali dimming options available

MOUNTING

Recessed

APPLICATION AREAS

Indoor, Commercial, Retail, Hospitality, Public Buildings

OPTIONS & ACCESSORIES

- Other CCT (K) available

TECHNICAL DATA

LRD1025

LRD1033

LAMP	LED	LED
TOTAL POWER (W)	25W	33W
SYSTEM OUTPUT (LM)	2940 / 2970LM	3527 / 3486LM
EFFICACY (LM/W)	99	95 / 94
CCT (K)	3500 / 4000K	3500 / 4000K
CRI (Ra)	80	80
BEAM ANGLE	10° / 24° / 42° / 64°	10° / 24° / 42° / 64°
OPERATING VOLTAGE-VAC	220-240V	220-240V
SOURCE POWER (W)	30W	36W
LIGHT OUTPUT (LM)	3417 / 3426LM	4135 / 4048LM
CURRENT (MA)	700MA	900MA
RATED LIFE (HRS)	50 000 HRS	50 000 HRS
ILLUM @ 1M (LUX)	21863 / 15892LX	26248 / 18458LX
FLICKER FACTOR	<4%	<4%
POWER FACTOR	≥0.9	≥0.9
R9 VALUE	12	12
UGR	<22	<22
MAC ADAM STEP	3SDCM	3SDCM
OPERATING TEMP °C	-20°C TO 50°C	-20°C TO 50°C
DIMENSIONS	D:φ180 x H:110mm	D:φ180 x H:110mm
CUT OUT	D:φ170mm	D:φ170mm

CD / KLM

● C0 - C180

● C90 - C270

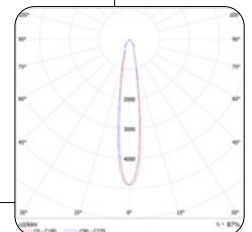

E&OE MAY OCCUR

LRD12

LED RECESSED
DOWNLIGHT

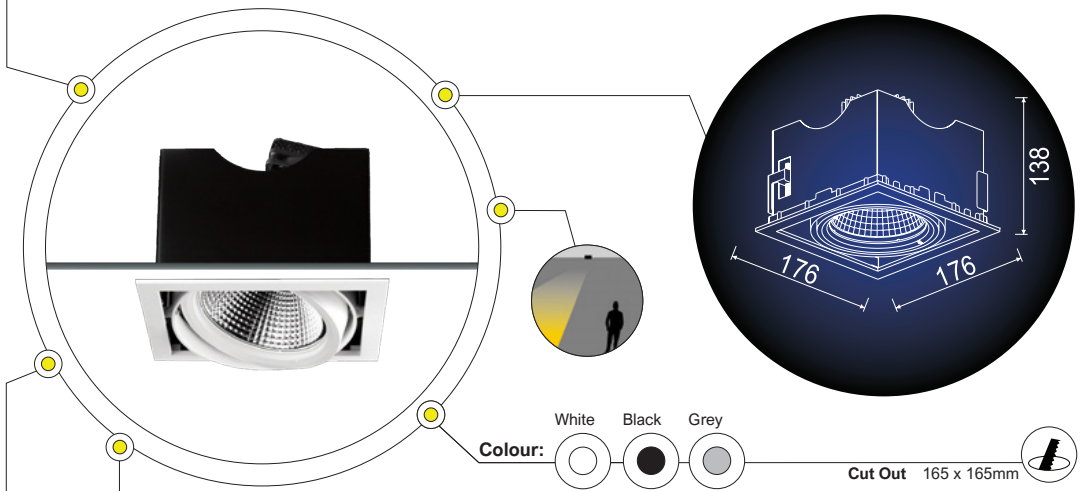

Cut Out 165 x 165mm

+ IP 20



LOA

5 YRS

ldt



PHYSICAL DATA

FEATURES

- Material: Aluminium
- The traditional commercial lighting fitting
- Higher reflective efficiency with the Alanrod Miro material
- Adjustable

- Special CCT available for meat, bread, fish, vegetables and clothing
- Lens options available

MOUNTING

Recessed

OPTIONS & ACCESSORIES

- TRIAC, 0-10V, Dali dimming options available

APPLICATION AREAS

Indoor, Commercial, Retail, Hospitality, Public Buildings

TECHNICAL DATA

	LRD1225	LRD1233
LAMP	LED	LED
TOTAL POWER (W)	25W	33W
SYSTEM OUTPUT (LM)	2940 / 2970LM	3527 / 3486LM
EFFICACY (LM/W)	99 / 99	95 / 94
CCT (K)	3500 / 4000K	3500 / 4000K
CRI (Ra)	80	80
BEAM ANGLE	10° / 24° / 42° / 64°	10° / 24° / 42° / 64°
OPERATING VOLTAGE-VAC	220-240V	220-240V
SOURCE POWER (W)	30W	36W
LIGHT OUTPUT (LM)	3417 / 3426LM	4135 / 4048LM
CURRENT (MA)	700MA	900MA
RATED LIFE (HRS)	50 000 HRS	50 000 HRS
ILLUM @ 1M (LUX)	21863 / 15892LX	26248 / 18458LX
FLICKER FACTOR	<4%	<4%
POWER FACTOR	≥0.9	≥0.9
R9 VALUE	12	12
UGR	<22	<22
MAC ADAM STEP	3SDCM	3SDCM
OPERATING TEMP °C	-20°C TO 50°C	-20°C TO 50°C
DIMENSIONS	L:176 x W:176 x H:138mm	L:176 x W:176 x H:138mm
CUT OUT	165 x 165mm	165 x 165mm

CD / KLM

- C0 - C180
- C90 - C270

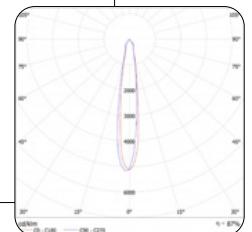

E&OE MAY OCCUR

LRD122

LED RECESSED
DOWNLIGHT

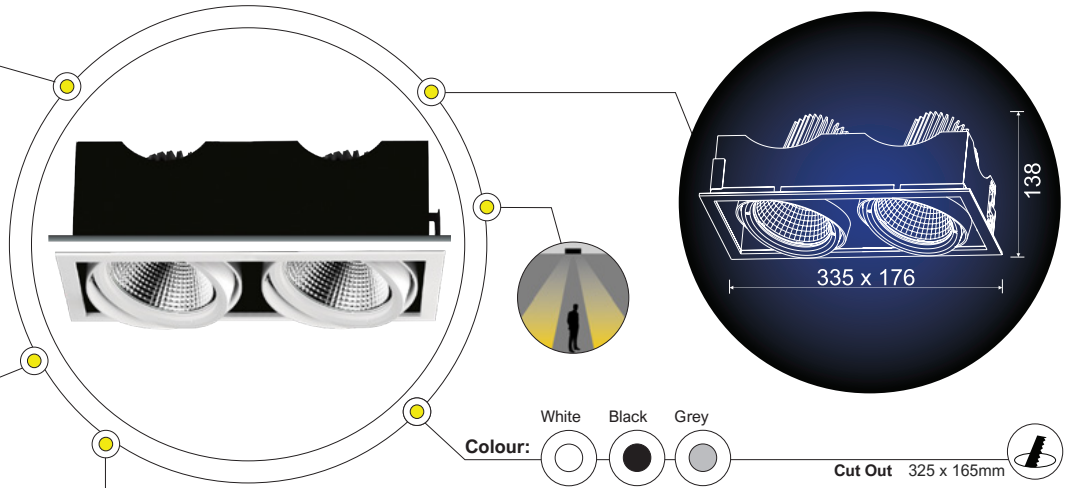

+ IP 20



LOA

5 YRS

ldt



PHYSICAL DATA

FEATURES

- Material: Aluminium
- The traditional commercial lighting fitting
- Higher reflective efficiency with the Alanrod Miro material
- Adjustable

OPTIONS & ACCESSORIES

- TRIAC, 0-10V, Dali dimming options available

- Special CCT available for meat, bread, fish, vegetables and clothing
- Lens options available

MOUNTING

Recessed

APPLICATION AREAS

Indoor, Commercial, Retail, Hospitality, Public Buildings

TECHNICAL DATA

LRD122

LAMP	LED
TOTAL POWER (W)	2 x 25W
SYSTEM OUTPUT (LM)	2841 / 2940 / 2970LM (x 2)
EFFICACY (LM/W)	95 / 99 / 99
CCT (K)	3000 / 3500 / 4000K
CRI (Ra)	80
BEAM ANGLE	10° / 24° / 42° / 64°
OPERATING VOLTAGE-VAC	220-240V
SOURCE POWER (W)	2 x 30W
LIGHT OUTPUT (LM)	3201 / 3417 / 3426LM (x 2)
CURRENT (MA)	900MA (x2)
RATED LIFE (HRS)	50 000 HRS
ILLUM @ 1M (LUX)	15224 / 21863 / 15892LX (x 2)
FLICKER FACTOR	<4%
POWER FACTOR	≥0.9
R9 VALUE	12
UGR	<22
MAC ADAM STEP	3SDCM
OPERATING TEMP °C	-20°C TO 50°C
DIMENSIONS	L:176 x W:176 x H:138mm
CUT OUT	325 x 165mm

Single 14° Beam Angle

- CD / KLM
- C0 - C180
 - C90 - C270

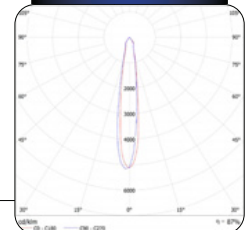

E&OE MAY OCCUR

LRD13

LED RECESSED
DOWNLIGHT

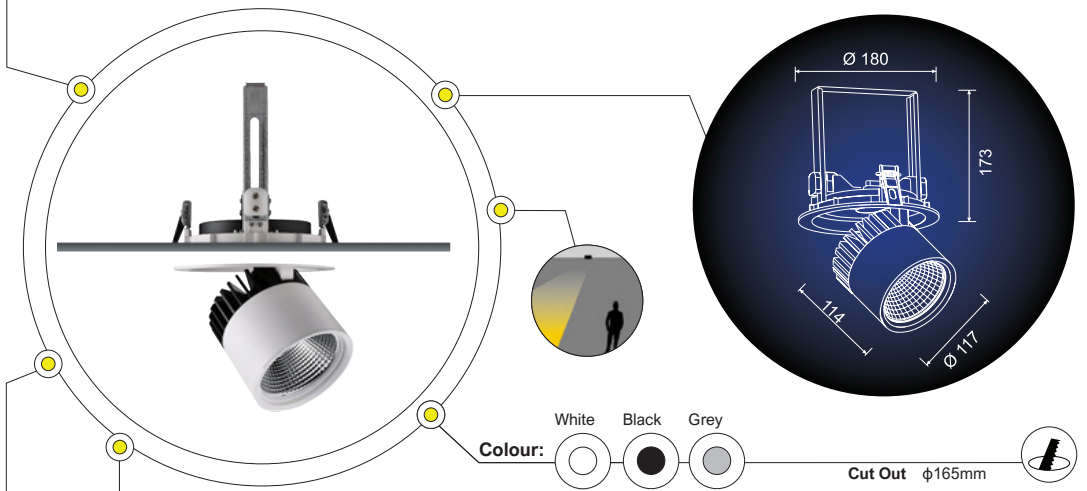

+ IP
20



LOA

5 YRS

ldt



PHYSICAL DATA

FEATURES

- Material: Aluminium
- The body can be recessed into the ceiling
- Adjustable
- Higher reflective efficiency with the Alanrod Miro material

- Special CCT available for meat, bread, fish, vegetables and clothing
- Lens options available

MOUNTING

Recessed

OPTIONS & ACCESSORIES

- TRIAC, 0-10V, Dali dimming options available

APPLICATION AREAS

Indoor, Commercial, Retail, Hospitality, Public Buildings

TECHNICAL DATA

	LRD1325	LRD1333
LAMP	LED	LED
TOTAL POWER (W)	25W	33W
SYSTEM OUTPUT (LM)	2940 / 2970LM	3527 / 3486LM
EFFICACY (LM/W)	99 / 99	95 / 94
CCT (K)	3500 / 4000K	3500 / 4000K
CRI (Ra)	80	80
BEAM ANGLE	10° / 24° / 42° / 64°	10° / 24° / 42° / 64°
OPERATING VOLTAGE-VAC	220-240V	220-240V
SOURCE POWER (W)	30W	36W
LIGHT OUTPUT (LM)	3417 / 3426LM	4135 / 4048LM
CURRENT (MA)	700MA	900MA
RATED LIFE (HRS)	50 000 HRS	50 000 HRS
ILLUM @ 1M (LUX)	21863 / 15892LX	26248 / 18458LX
FLICKER FACTOR	<4%	<4%
POWER FACTOR	≥0.9	≥0.9
R9 VALUE	12	12
UGR	<22	<22
MAC ADAM STEP	3SDCM	3SDCM
OPERATING TEMP °C	-20°C TO50°C	-20°C TO 50°C
DIMENSIONS	D:φ180 x H:173mm	D:φ180 x H:173mm
CUT OUT	D:φ165mm	D:φ165mm

CD / KLM

- C0 - C180
- C90 - C270

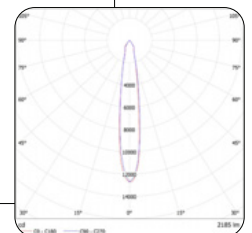

E&OE MAY OCCUR

LRD14

LED RECESSED
DOWNLIGHT

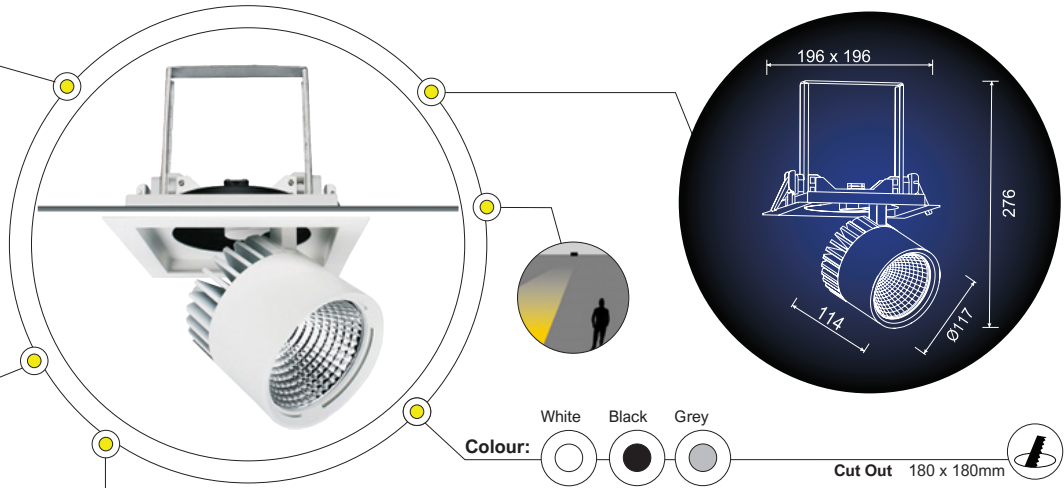

+ IP 20



LOA

5 YRS

ldt



PHYSICAL DATA

FEATURES

- Material: Aluminium
- The body can be recessed into the ceiling
- Adjustable and extractable
- Higher reflective efficiency with the Alanrod Miro material

- Special CCT available for meat, bread, fish, vegetables and clothing
- Lens options available

OPTIONS & ACCESSORIES

- TRIAC, 0-10V, Dali dimming options available

MOUNTING

Recessed

APPLICATION AREAS

Indoor, Commercial, Retail, Hospitality, Public Buildings

TECHNICAL DATA

LRD1425

LRD1433

	LRD1425	LRD1433
LAMP	LED	LED
TOTAL POWER (W)	25W	33W
SYSTEM OUTPUT (LM)	2940 / 2970LM	3527 / 3486LM
EFFICACY (LM/W)	99 / 99	95 / 94
CCT (K)	3500 / 4000K	3500 / 4000K
CRI (Ra)	80	80
BEAM ANGLE	10° / 24° / 42° / 64°	10° / 24° / 42° / 64°
OPERATING VOLTAGE-VAC	220-240V	220-240V
SOURCE POWER (W)	30W	36W
LIGHT OUTPUT (LM)	3417 / 3426LM	4135 / 4048LM
CURRENT (MA)	700MA	900MA
RATED LIFE (HRS)	50 000 HRS	50 000 HRS
ILLUM @ 1M (LUX)	21863 / 15892LX	26248 / 18458LX
FLICKER FACTOR	<4%	<4%
POWER FACTOR	≥0.9	≥0.9
R9 VALUE	12	12
UGR	<22	<22
MAC ADAM STEP	3SDCM	3SDCM
OPERATING TEMP °C	-20°C TO 50°C	-20°C TO 50°C
DIMENSIONS	L:196 x W:196 x H:173mm	L:196 x W:196 x H:173mm
CUT OUT	180 x 180mm	180 x 180mm

CD / KLM

● C0 - C180

● C90 - C270

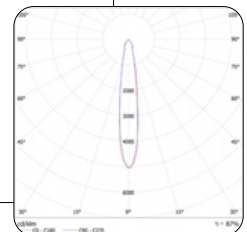

E&OE MAY OCCUR

LRD142

LED RECESSED
DOWNLIGHT

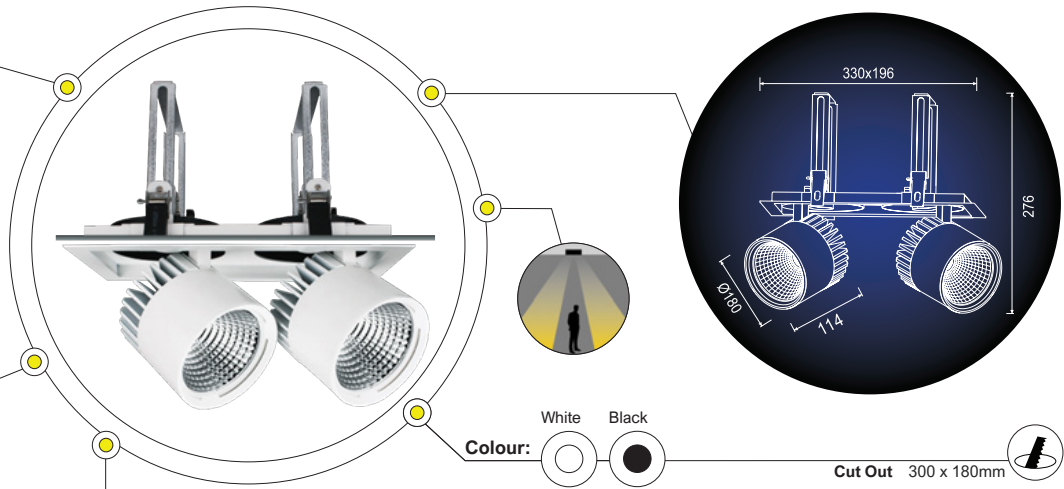

+IP
20



LOA

✓
5 YRS

ldt



PHYSICAL DATA

FEATURES

- Material: Aluminium
- The body can be recessed into the ceiling
- Adjustable and extractable
- Higher reflective efficiency with the Alanrod Miro material

- Special CCT available for meat, bread, fish, vegetables and clothing
- Lens options available

OPTIONS & ACCESSORIES

- TRIAC, 0-10V, Dali dimming options available

MOUNTING

Recessed

APPLICATION AREAS

Indoor, Commercial, Retail, Hospitality, Public Buildings

TECHNICAL DATA

	LRD14225	LRD14233
LAMP	LED	LED
TOTAL POWER (W)	2 x 25W	2 x 33W
SYSTEM OUTPUT (LM)	2841 / 2940 / 2970LM (x2)	3204 / 3527 / 3486LM (x2)
EFFICACY (LM/W)	95 / 99 / 99	86 / 95 / 94
CCT (K)	3000 / 3500 / 4000K	3000 / 3500 / 4000K
CRI (Ra)	80	80
BEAM ANGLE	10° / 24° / 42° / 64°	10° / 24° / 42° / 64°
OPERATING VOLTAGE-VAC	220-240V	220-240V
SOURCE POWER (W)	2 x 30W	2 x 36W
LIGHT OUTPUT (LM)	3201 / 3417 / 3426LM (x2)	3851 / 4135 / 4048LM (x2)
CURRENT (MA)	500MA (x2)	900MA (x2)
RATED LIFE (HRS)	50 000 HRS	50 000 HRS
ILLUM @ 1M (LUX)	15224/21863/15892LX (x2)	17410/26248/18458LX (x2)
FLICKER FACTOR	<4%	<4%
POWER FACTOR	≥0.9	≥0.9
R9 VALUE	11	12
UGR	<22	<22
MAC ADAM STEP	3SDCM	3SDCM
OPERATING TEMP °C	-20°C TO 50°C	-20°C TO 50°C
DIMENSIONS	D:180 x W:114 x H:276mm	D:180 x W:114 x H:276mm
CUT OUT	300 x 180mm	300 x 180mm

Single 14° Beam Angle

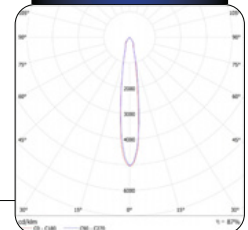

CD / KLM

● C0 - C180

● C90 - C270

E&OE MAY OCCUR

LRD16

LED RECESSED
DOWNLIGHT

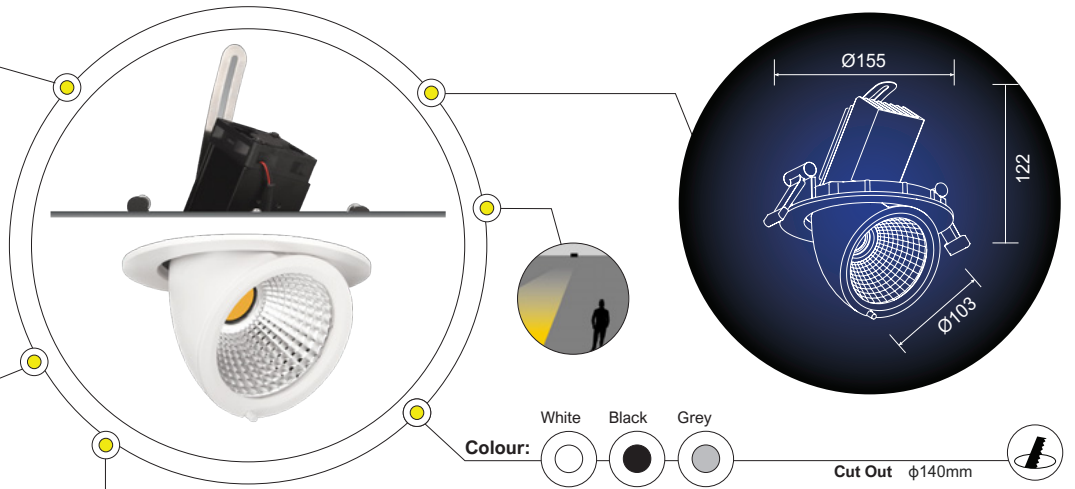

+ IP
20



LOA

5 YRS

ldt



PHYSICAL DATA

FEATURES

- Material: Die-cast aluminium and PC lens
- High performance fitting
- Higher reflective efficiency with the Alanrod Miro material
- Adjustable

- LED MacAdam <2 also available
- Special CCT available for meat, bread, fish, vegetables and clothing
- Lens options available

MOUNTING: Recessed

OPTIONS & ACCESSORIES

- CRI82, CRI93 and CRI97 available

APPLICATION AREAS: Indoor, Commercial, Retail, Hospitality, Public Buildings

TECHNICAL DATA

	LRD1617	LRD1625
LAMP	LED	LED
TOTAL POWER (W)	17W	25W
SYSTEM OUTPUT (LM)	1845 / 1924LM	2501 / 2550LM
EFFICACY (LM/W)	89 / 92	85 / 85
CCT (K)	3500 / 4000K	3500 / 4000K
CRI (Ra)	80	80
BEAM ANGLE	20° / 37°	20° / 37°
OPERATING VOLTAGE-VAC	220-240V	220-240V
SOURCE POWER (W)	20W	29W
LIGHT OUTPUT (LM)	2443 / 2479LM	3417 / 3426LM
CURRENT (MA)	500MA	700MA
RATED LIFE (HRS)	50 000 HRS	50 000 HRS
ILLUM @ 1M (LUX)	6197 / 6443LX	8950 / 8662LX
FLICKER FACTOR	<4%	<4%
POWER FACTOR	≥0.9	≥0.9
R9 VALUE	11	12
UGR	<22	<22
MAC ADAM STEP	3SDCM	3SDCM
OPERATING TEMP °C	-20°C TO 50°C	-20°C TO 50°C
DIMENSIONS	D:φ103 x W:155 x H:122mm	D:φ103 x W:155 x H:122mm
CUT OUT	D:φ140mm	D:φ140mm

CD / KLM

- C0 - C180
- C90 - C270

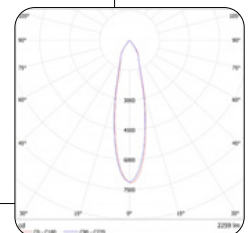

E&OE MAY OCCUR

LRD16L

LED RECESSED
DOWNLIGHT



+ IP 20



LOA

5 YRS

ldt



PHYSICAL DATA

FEATURES

- Material: Die-cast aluminium and PC lens
- High performance fitting
- Higher reflective efficiency with the Alanrod Miro material
- Adjustable

OPTIONS & ACCESSORIES

- CRI82, CRI93 and CRI97 available
- LED MacAdam <2 also available

- Special CCT available for meat, bread, fish, vegetables and clothing
- Lens options available
- TRIAC, 1-10V or DALI Dimming for selection

MOUNTING: Recessed

APPLICATION AREAS: Indoor, Commercial, Retail, Hospitality, Public Buildings

TECHNICAL DATA

LRD16L

LAMP	LED
TOTAL POWER (W)	38W
SYSTEM OUTPUT (LM)	3850LM
EFFICACY (LM/W)	101
CCT (K)	3000 / 3500 / 4000 / 5000K
CRI (Ra)	90
BEAM ANGLE	15° / 24° / 44° / 59°
OPERATING VOLTAGE-VAC	220-240V
SOURCE POWER (W)	32W
LIGHT OUTPUT (LM)	4000LM
CURRENT (MA)	500MA
RATED LIFE (HRS)	50 000 HRS
FLICKER FACTOR	<4%
R9 VALUE	16
UGR	22
MAC ADAM STEP	3SDCM
OPERATING TEMP °C	-20°C TO 50°C
DIMENSIONS	D:φ124 x H:141mm
CUT OUT	D:φ162mm

24° Beam Angle

- CD / KLM
- C0 - C180
 - C90 - C270

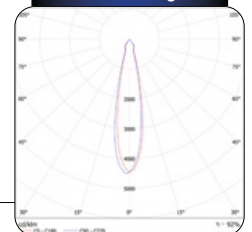

E&OE MAY OCCUR

LRD17

LED RECESSED
DOWNLIGHT

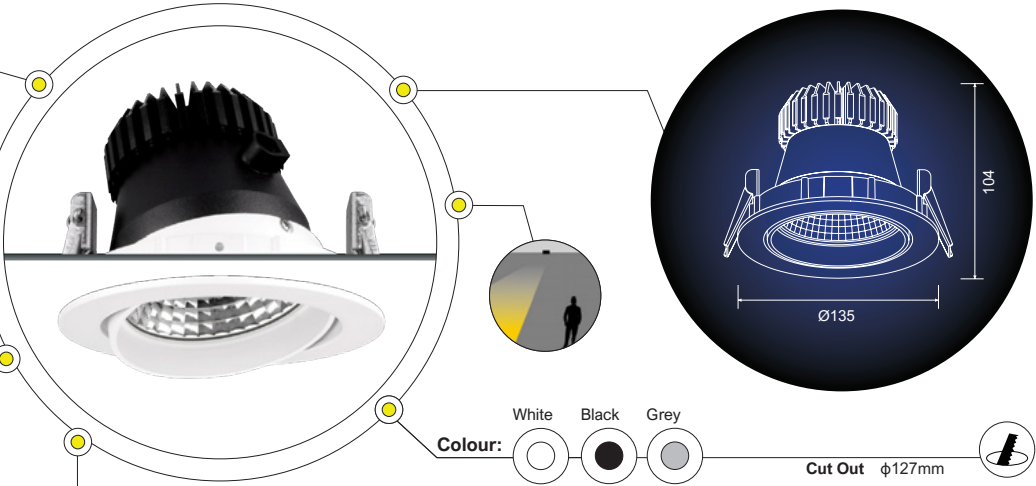

+ IP 20



LOA

5 YRS

ldt



PHYSICAL DATA

FEATURES

- Material: Aluminium
- Higher reflective efficiency with the Alanrod Miro material
- Adjustable

MOUNTING

Recessed

APPLICATION AREAS

Indoor, Commercial, Retail, Hospitality, Public Buildings

OPTIONS & ACCESSORIES

- TRIAC, 0-10V, Dali dimming options available
- Lens options available

TECHNICAL DATA

	LRD1717	LRD1725	LRD1733
LAMP	LED	LED	LED
TOTAL POWER (W)	17W	25W	33W
SYSTEM OUTPUT (LM)	1748 / 1592LM	2569 / 2758LM	2997 / 3219LM
EFFICACY (LM/W)	92 / 76	87 / 91	82 / 86
CCT (K)	3500 / 4000K	3500 / 4000K	3500 / 4000K
CRI (Ra)	80	80	80
BEAM ANGLE	21° / 39°	21° / 39°	21° / 39°
OPERATING VOLTAGE-VAC	220-240V	220-240V	220-240V
SOURCE POWER (W)	20W	30W	36W
LIGHT OUTPUT (LM)	2236 / 1939LM	3417 / 3426LM	4153 / 4048LM
CURRENT (MA)	500MA	700MA	900MA
RATED LIFE (HRS)	50 000 HRS	50 000 HRS	50 000 HRS
ILLUM @ 1M (LUX)	5352 / 3831LX	7941 / 5940LX	9274 / 6453LX
FLICKER FACTOR	<4%	<4%	<4%
POWER FACTOR	≥0.9	≥0.9	≥0.9
R9 VALUE	11	12	12
UGR	<19	<19	<19
MAC ADAM STEP	3SDCM	3SDCM	3SDCM
OPERATING TEMP °C	-20°C TO 50°C	-20°C TO 50°C	-20°C TO 50°C
DIMENSIONS	D:φ135 x H:104mm	D:φ135 x H:104mm	D:φ135 x H:104mm
CUT OUT	D:φ127mm	D:φ127mm	D:φ127mm

CD / KLM

● C0 - C180

● C90 - C270

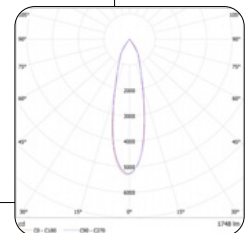

E&OE MAY OCCUR

LRD18

LED RECESSED
DOWNLIGHT

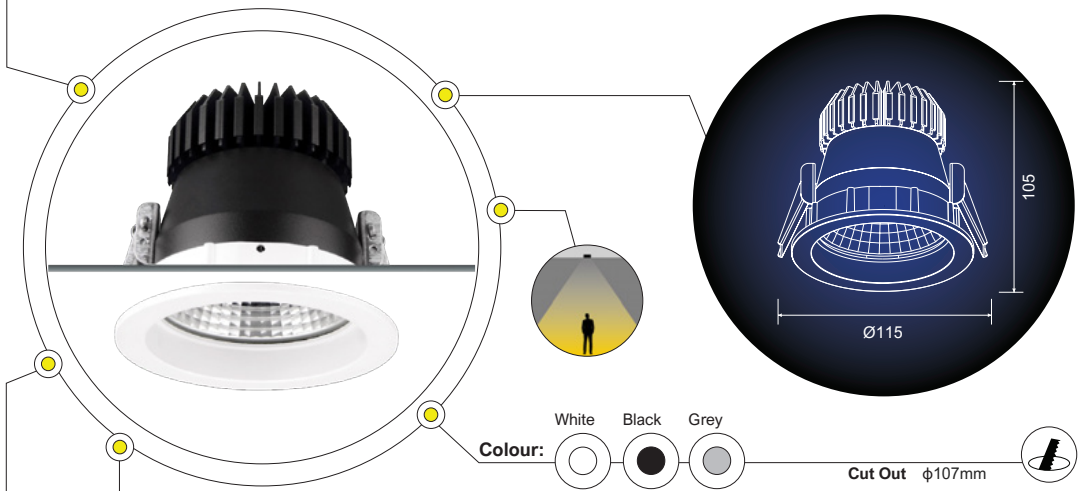

+ IP 20



LOA

5 YRS

ldt



PHYSICAL DATA

FEATURES

- Material: Aluminium and Polycarbonate
- Higher reflective efficiency with the Alanrod Miro material

OPTIONS & ACCESSORIES

- TRIAC, 0-10V, Dali dimming options available
- Lens options available

MOUNTING

Recessed

APPLICATION AREAS

Indoor, Commercial, Retail, Hospitality, Public Buildings

TECHNICAL DATA

	LRD1817	LRD1825	LRD1833
LAMP	LED	LED	LED
TOTAL POWER (W)	17W	25W	33W
SYSTEM OUTPUT (LM)	1748 / 1592LM	2569 / 2758LM	2997 / 3219LM
EFFICACY (LM/W)	92 / 76	87 / 91	82 / 86
CCT (K)	3500 / 4000K	3500 / 4000K	4000K
CRI (Ra)	80	80	80
BEAM ANGLE	21° / 39°	21° / 39°	21° / 39°
OPERATING VOLTAGE-VAC	220-240V	220-240V	220-240V
SOURCE POWER (W)	20W	30W	36W
LIGHT OUTPUT (LM)	2236 / 1939LM	3417 / 3426LM	4135 / 4048LM
CURRENT (MA)	500MA	700MA	900MA
RATED LIFE (HRS)	50 000 HRS	50 000 HRS	50 000 HRS
ILLUM @ 1M (LUX)	5352 / 3831LX	7941 / 5940LX	9274 / 6453LX
FLICKER FACTOR	<4%	<4%	<4%
POWER FACTOR	≥0.9	≥0.9	≥0.9
R9 VALUE	11	12	12
UGR	<19	<19	<19
MAC ADAM STEP	3SDCM	3SDCM	3SDCM
OPERATING TEMP °C	-20°C TO 50°C	-20°C TO 50°C	-20°C TO 50°C
DIMENSIONS	D:φ115 x H:105mm	D:φ115 x H:105mm	D:φ115 x H:105mm
CUT OUT	D:φ107mm	D:φ107mm	D:φ107mm

CD / KLM

- C0 - C180
- C90 - C270

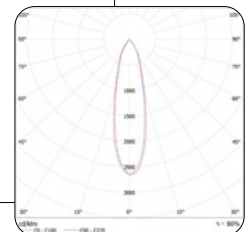

E&OE MAY OCCUR

LRD20S

LED RECESSED
DOWNLIGHT

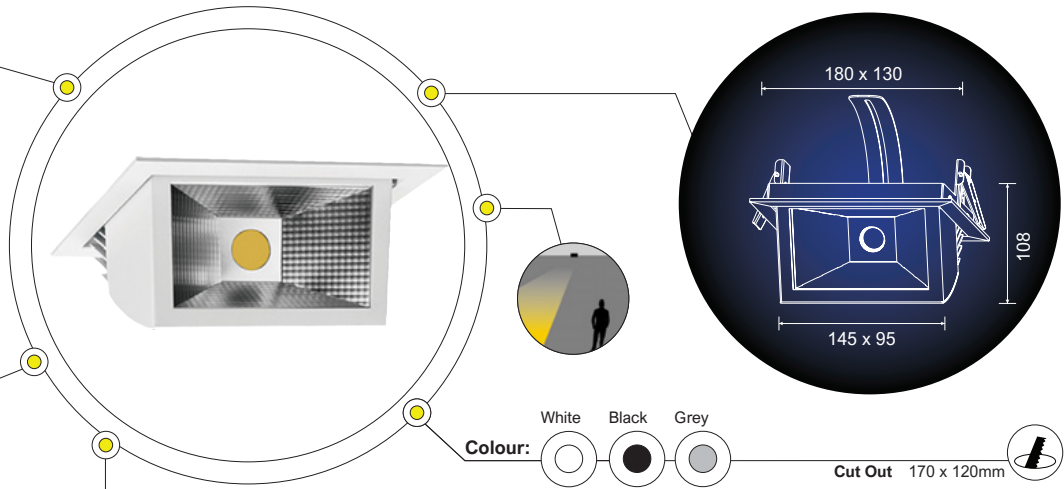

PHYSICAL DATA

FEATURES

- Material: Aluminium / Iron
- Designed with a wider beam reflector - provides a uniform wall-wash lighting effect
- Higher reflective efficiency with the ALANOD MIRO material
- Flex and plug or direct connection

- CRI 82, CRI 93 and CRI 97 available
- Special CCT options available for the lighting of meat, bread, fish, vegetables and clothing
- Glass accessory available

MOUNTING

Recessed

OPTIONS & ACCESSORIES

- TRIAC, 0-10V and DALI Dimming

APPLICATION AREAS: Indoor, Commercial, Retail, Hospitality, Public Buildings

TECHNICAL DATA

LRD20S17

LRD20S25

	LRD20S17	LRD20S25
LAMP	LED	LED
TOTAL POWER (W)	17W	24W
SYSTEM OUTPUT (LM)	1786 / 2041LM	2603 / 2744LM
EFFICACY (LM/W)	86 / 98	88 / 91
CCT (K)	3500 / 4000K	3500 / 4000K
CRI (Ra)	80	80
BEAM ANGLE	78°	78°
OPERATING VOLTAGE-VAC	220-240VAC	220-240VAC
SOURCE POWER (W)	20W	29W
LIGHT OUTPUT (LM)	2443 / 2479LM	3390 / 3426LM
CURRENT (MA)	500MA	700MA
RATED LIFE (HRS)	50 000 HRS	50 000 HRS
ILLUM @ 1M (LUX)	781 / 888LX	1137 / 1196LX
FLICKER FACTOR	<4%	<4%
POWER FACTOR	≥0,9	≥0,9
R9 VALUE	11	12
UGR	<25	<25
MAC ADAM STEP	3SDCM	3SDCM
OPERATING TEMP °C	-20°C TO 50°C	-20°C TO 50°C
DIMENSIONS	L:180 x W:130 x H:108mm	L:180 x W:130 x H:108mm
CUT OUT	170 x 120mm	170 x 120mm

CD / KLM

- C0 - C180
- C90 - C270

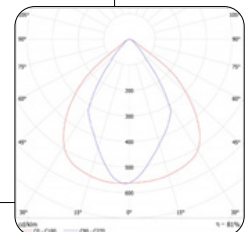

E&OE MAY OCCUR

LRD24

LED RECESSED
DOWNLIGHT

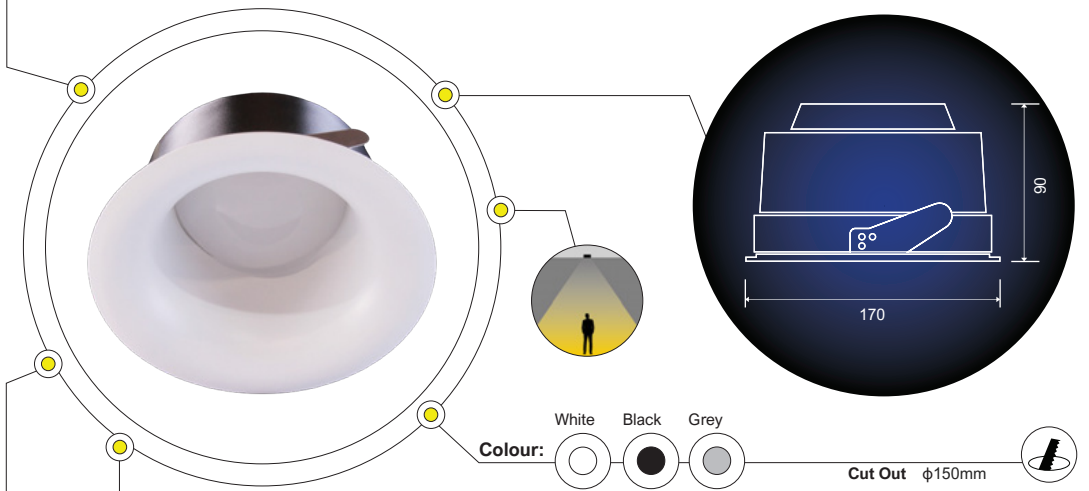

+IP 20



LOA

5 YRS

ldt



PHYSICAL DATA

FEATURES

- Material: Aluminium

OPTIONS & ACCESSORIES

- TRIAC, 0-10V, Dali dimming options available

MOUNTING

Recessed

APPLICATION AREAS

Indoor, Commercial, Retail, Hospitality, Public Buildings

TECHNICAL DATA

LRD2413

LAMP	LED
TOTAL POWER (W)	12W
SYSTEM OUTPUT (LM)	579 / 633LM
EFFICACY (LM/W)	38 / 46
CCT (K)	3500 / 4000K
CRI (Ra)	80
BEAM ANGLE	76°
OPERATING VOLTAGE-VAC	220-240V
SOURCE POWER (W)	13W
LIGHT OUTPUT (LM)	1701 / 1886LM
CURRENT (MA)	350MA
RATED LIFE (HRS)	50 000 HRS
ILLUM @ 1M (LUX)	192LX
FLICKER FACTOR	<4%
POWER FACTOR	≥0.9
UGR	<15
MAC ADAM STEP	3SDCM
OPERATING TEMP °C	-20°C TO 50°C
DIMENSIONS	D:φ170 x H:90mm
CUT OUT	D:φ150mm

CD / KLM

● C0 - C180

● C90 - C270

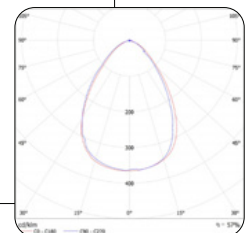

E&OE MAY OCCUR

LRD37

LED RECESSED
DOWNLIGHT

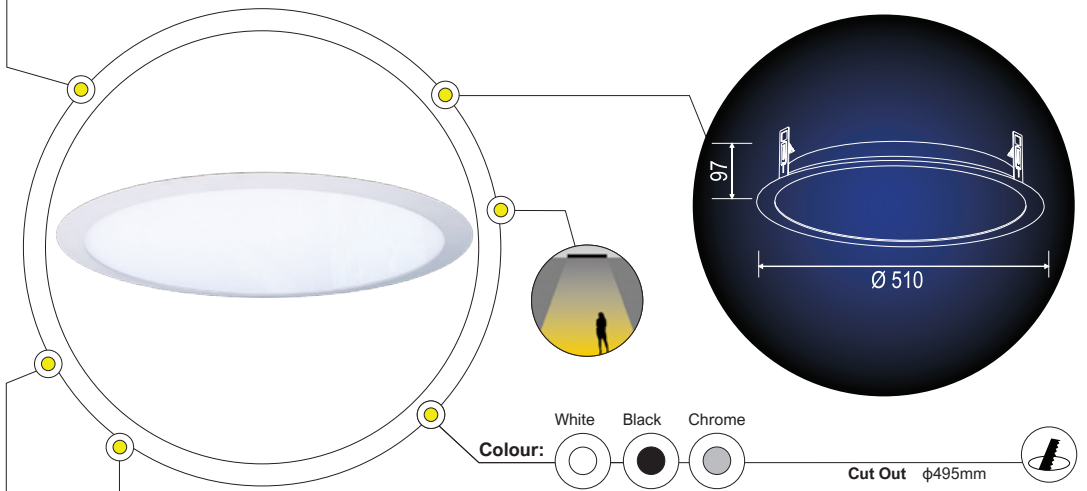

+ IP 20



LOA

5 YRS

ldt



PHYSICAL DATA

FEATURES

- Material: Aluminium and Polycarbonate
- Flood LED panel light

- Pendant, Recessed version and Surface mounted versions available

OPTIONS & ACCESSORIES

- TRIAC, 0-10V, Dali dimming options available
- D:φ350mm and D:φ710mm diameter options available in the recessed panel light series

MOUNTING

Recessed

APPLICATION AREAS

Indoor, Commercial, Retail, Hospitality, Public Buildings

TECHNICAL DATA

LRD37

LAMP	LED
TOTAL POWER (W)	30W
SYSTEM OUTPUT (LM)	3468 / 3529LM
EFFICACY (LM/W)	102 / 105
CCT (K)	3500 / 4000K
CRI (Ra)	80
BEAM ANGLE	108°
OPERATING VOLTAGE-VAC	220-240V
SOURCE POWER (W)	32W
LIGHT OUTPUT (LM)	4359 / 4435LM
CURRENT (MA)	700MA
RATED LIFE (HRS)	50 000HRS
ILLUM @ 1M (LUX)	455 / 451LX
FLICKER FACTOR	<4%
POWER FACTOR	≥0.9
R9 VALUE	11
UGR	<22
MAC ADAM STEP	3SDCM
OPERATING TEMP °C	-20°C to 50°C
DIMENSIONS	D:φ510 x H:97mm
CUT OUT	D:φ495mm

CD / KLM

● C0 - C180

● C90 - C270

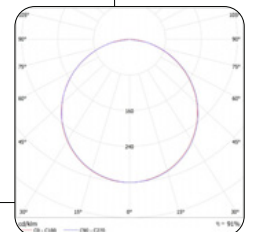

E&OE MAY OCCUR

LRD55

LED RECESSED
DOWNLIGHT

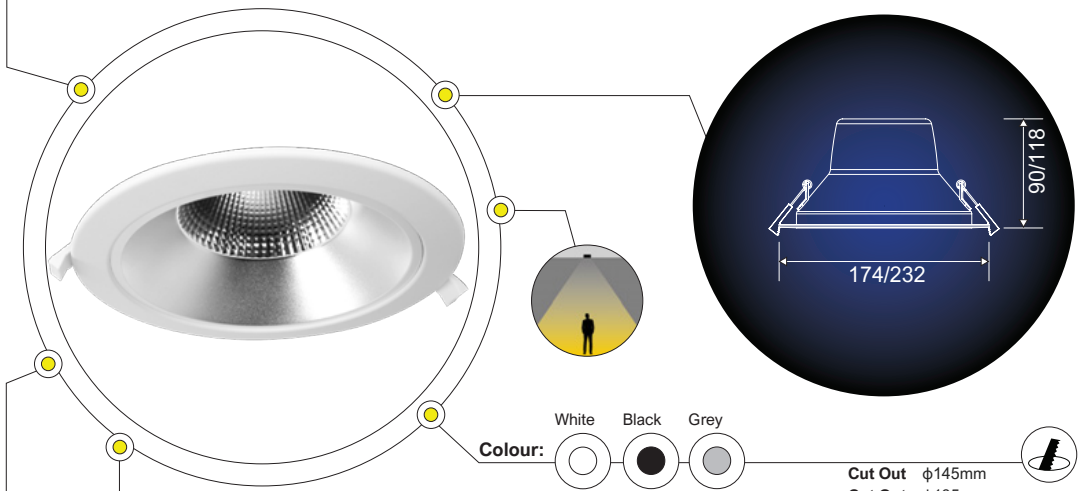

+ IP 20



LOA

5 YRS

ldt

PHYSICAL DATA

FEATURES

- Material: White powder-coated aluminium with polycarbonate diffuser with silver-finish reflector
- LED replacement for 2x18W Fluorescent downlight
- Very low glare with UGR <19
- Stainless steel spring clips
- Complete with total length of 0.83m of flex and SWIFT 4 pin male/female plug & play connector with large terminals and integrated cable restraint. Fast, simple

and efficient instability

- Suitable for switching by PIR, Microwave or Photocell

MOUNTING

Recessed

APPLICATION AREAS

Indoor, Commercial, Retail, Hospitality, Public Buildings

TECHNICAL DATA

LRD55204031

LRD55284031

LAMP	LED	LED
TOTAL POWER (W)	20W	28W
SYSTEM OUTPUT (LM)	1850LM	2740 LM
EFFICACY (LM/W)	93	96
CCT (K)	4000K	4000K
CRI (Ra)	80	80
BEAM ANGLE	50°	50°
OPERATING VOLTAGE-VAC	220-240V	220-240V
RATED LIFE (HRS)	50 000HRS	50 000HRS
ILLUM @ 1M (LUX)	2580LX	3570LX
POWER FACTOR	0.95	0.95
UGR	<19	<22
MAC ADAM STEP	6	6
OPERATING TEMP °C	-20°C to +40°C	-20°C to +40°C
WEIGHT (KG)	0.35KG	0.5KG
DIMENSIONS	D:φ174 x H:90mm	D:φ232 x H:118mm
CUT OUT	D:φ145 mm	D:φ195 mm

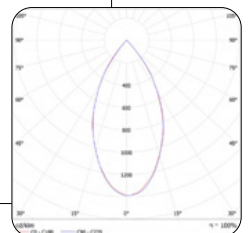

CD / KLM

● C0 - C180

● C90 - C270

E&OE MAY OCCUR

ULTIMUM

LED RECESSED
DOWNLIGHT

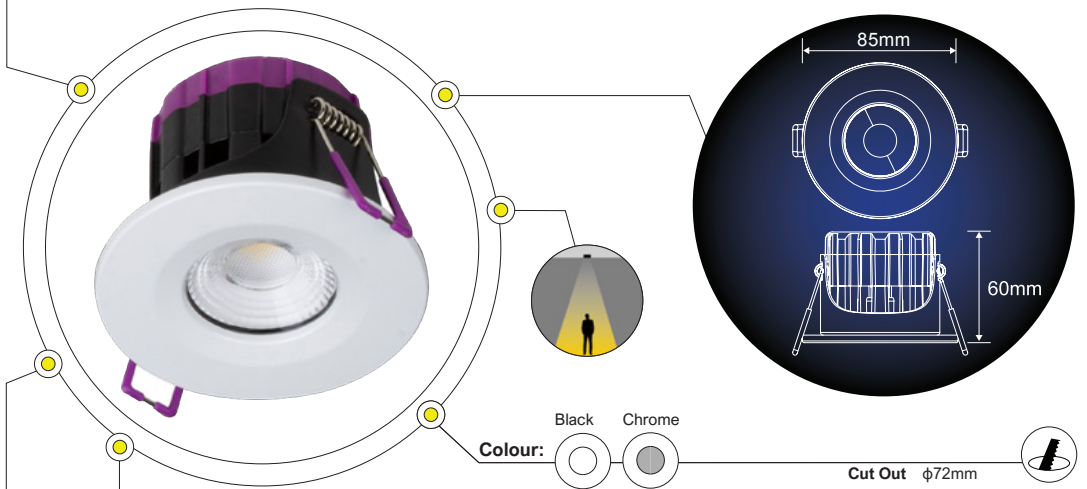

+ IP 65



LOA

3 YRS

ldt

COLOUR SELECTABLE

PHYSICAL DATA

FEATURES

- Colour temperature selectable
- LEDchroic lens replicating halogen dichroic with uniform, shadow-free light
- Designed and tested to retain the integrity of 30, 60 and 90 minute fire rated ceilings
- Shallow profile of only 60mm depth
- Pre-wired with 0.3m of flex
- Complete with 3-way double push-in connector block allowing loop in loop out

OPTIONS & ACCESSORIES

- Chrome and brushed chrome trims available
- Compatible with selected trailing and leading edge dimmers

MOUNTING: Recessed

APPLICATION AREAS: Indoor, Commercial, Residential, Retail, Hospitality

TECHNICAL DATA

RUL05X0

LAMP	LED
TOTAL POWER (W)	5W
SYSTEM OUTPUT (LM)	400 / 450 / 420LM
EFFICACY (LM/W)	86 / 99 / 88
CCT (K)	3000K / 4000K / 6000K
CRI (Ra)	80
BEAM ANGLE	60°

OPERATING VOLTAGE-VAC	220-240V
RATED LIFE (HRS)	30 000HRS
OPERATING TEMP °C	-20°C to +40°C
POWER FACTOR	0,9
ILLUM @ 1M (LUX)	280 / 310 / 290
WEIGHT (KG)	0.24KG
DIMENSIONS	D:φ85 x H60mm
CUT OUT	D:φ72mm

BLACK TRIM RULTRIM10



CHROME TRIM TRIM13



CD / KLM

● C0 - C180

● C90 - C270

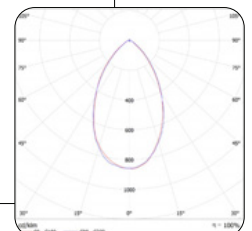

E&OE MAY OCCUR

> DOWNLIGHTS - RECESSED

SPOTS



FAVOR INS R

LED RECESSED DOWNLIGHT

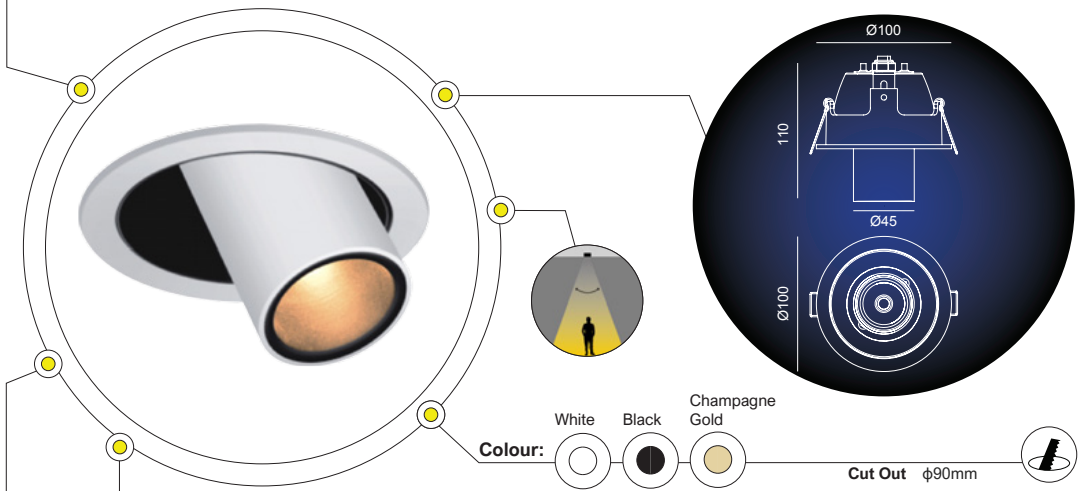

+ IP 20



LOA

5 YRS

ldt



PHYSICAL DATA

FEATURES

- Material: Aluminium
- The FAVOR is an excellent choice for your lighting requirements; the range is great for accent lighting; with both narrow and wide beam angles. The range includes square and round recessed and surface mounted options, adjustable and rotatable options, pendant lights, surface spotlights as well as track applications
- Adjustable, TRIAC Dimmable

OPTIONS & ACCESSORIES

- On/Off, DALI and DIM 0/1-10V dimming options available
- Round, square and trimless options available

MOUNTING: Recessed

APPLICATION AREAS: Indoor, Commercial, Residential, Retail, Hospitality

TECHNICAL DATA

LF177912EDT

LAMP	LED
TOTAL POWER (W)	9.5W
SYSTEM OUTPUT (LM)	388LM
CCT (K)	2700 / 3000 / 4000K
CRI (Ra)	90
BEAM ANGLE	19° / 28°

OPERATING VOLTAGE-VAC	220-240V
SOURCE POWER (W)	11.4W
SOURCE OUTPUT (LM)	957LM
DIMMING RANGE	30-100%
FLICKER FACTOR	100.67HZ / 2.13%
WEIGHT (KG)	0.49KG
DIMENSIONS	D:Ø100 x 110mm
CUT OUT	D:Ø90mm

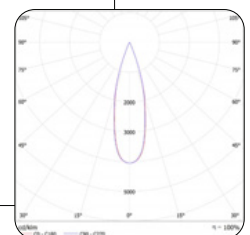

E&OE MAY OCCUR

FAVOR INS R TRIMLESS

LED RECESSED
DOWNLIGHT

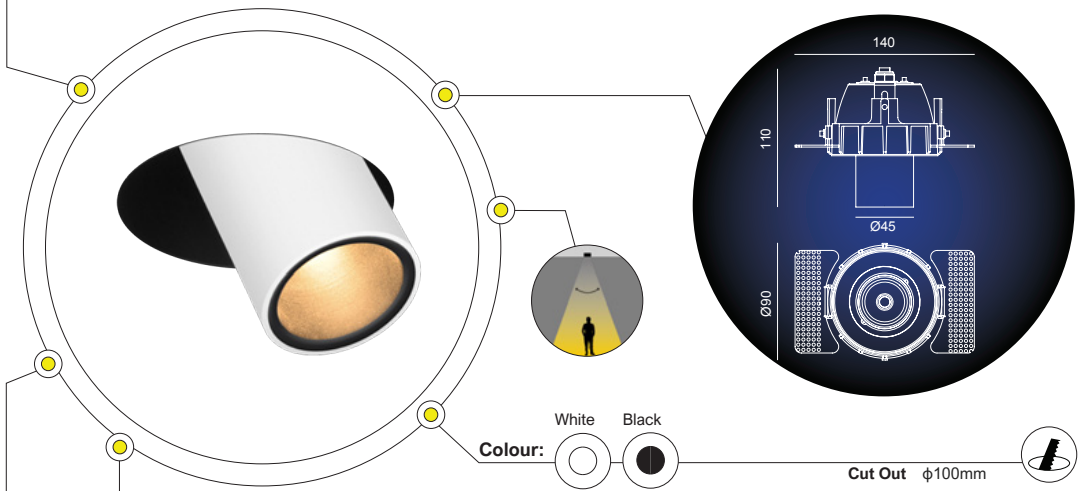

+ IP 20



LOA

5 YRS

ldt



PHYSICAL DATA

FEATURES

- Material: Aluminium
- The FAVOR is an excellent choice for your lighting requirements; the range is great for accent lighting; with both narrow and wide beam angles. The range includes square and round recessed and surface mounted options, adjustable and rotatable options, pendant lights, surface spotlights as well as track applications
- Adjustable and TRIAC dimmable

OPTIONS & ACCESSORIES

- On/Off , DALI and DIM 0/1-10V dimming options available
- Round, square and trimless options available

MOUNTING

Recessed, skimmed in

APPLICATION AREAS: Indoor, Commercial, Residential, Retail, Hospitality

TECHNICAL DATA

LF178312EDT

LAMP	LED
TOTAL POWER (W)	9.5W
SYSTEM OUTPUT (LM)	388LM
CCT (K)	2700 / 3000 / 4000K
CRI (Ra)	90
BEAM ANGLE	28°

OPERATING VOLTAGE-VAC	220-240V
SOURCE POWER (W)	12W
SOURCE OUTPUT (LM)	957LM
CURRENT (MA)	500MA
DIMMING RANGE	30-100%
FLICKER FACTOR	100.67HZ / 2.13%
WEIGHT (KG)	0.63KG
DIMENSIONS	140 x 90 x 110mm
CUT OUT	D:φ100mm



Project SANS, Cape Town

- CD / KLM
- C0 - C180
 - C90 - C270

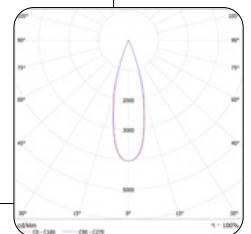

E&OE MAY OCCUR

FAVOR INM R

LED RECESSED DOWNLIGHT

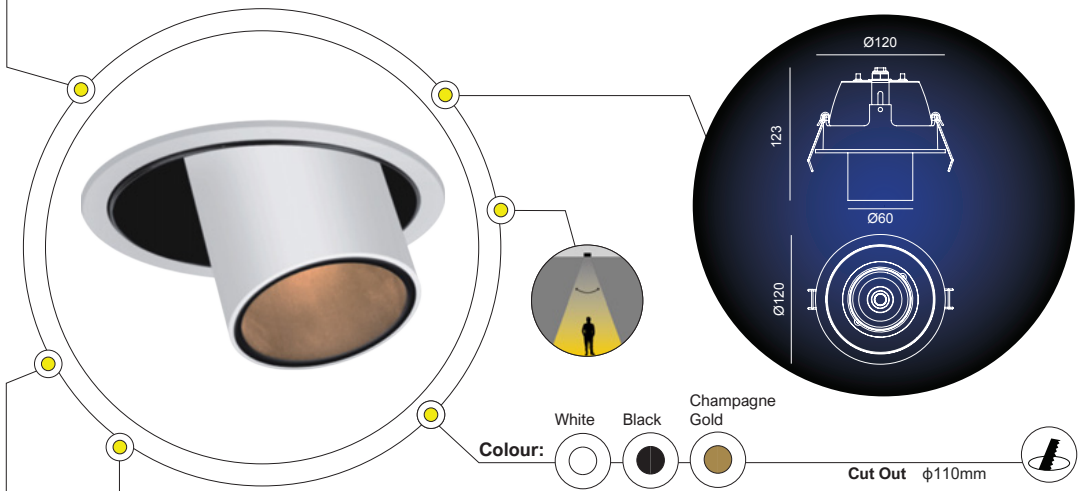

+ IP 20



LOA

5 YRS

ldt



PHYSICAL DATA

FEATURES

- Material: Aluminium
- The FAVOR is an excellent choice for your lighting requirements; the range is great for accent lighting; with both narrow and wide beam angles. The range includes square and round recessed and surface mounted options, adjustable and rotatable options, pendant lights, surface spotlights as well as track applications
- Adjustable, TRIAC Dimmable

OPTIONS & ACCESSORIES

- On/Off, DALI and DIM 0/1-10V dimming options available
- Round, square and trimless options available

MOUNTING: Recessed

APPLICATION AREAS: Indoor, Commercial, Residential, Retail, Hospitality

TECHNICAL DATA

LF178012EDT

LAMP	LED
TOTAL POWER (W)	13.9W
SYSTEM OUTPUT (LM)	537LM
CCT (K)	2700 / 3000 / 4000K
CRI (Ra)	90
BEAM ANGLE	18° / 32°

OPERATING VOLTAGE-VAC	220-240V
SOURCE POWER (W)	16.4W
SOURCE OUTPUT (LM)	1465LM
DIMMING RANGE	30-100%
FLICKER FACTOR	124HZ / 0.22%
WEIGHT (KG)	0.7KG
DIMENSIONS	D:φ120 x 123mm
CUT OUT	D:φ110mm



- CD / KLM
- C0 - C180
 - C90 - C270

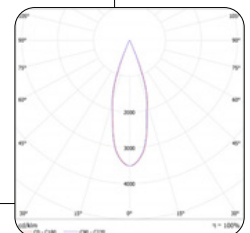

E&OE MAY OCCUR

FAVOR INM R TRIMLESS

LED RECESSED
DOWNLIGHT

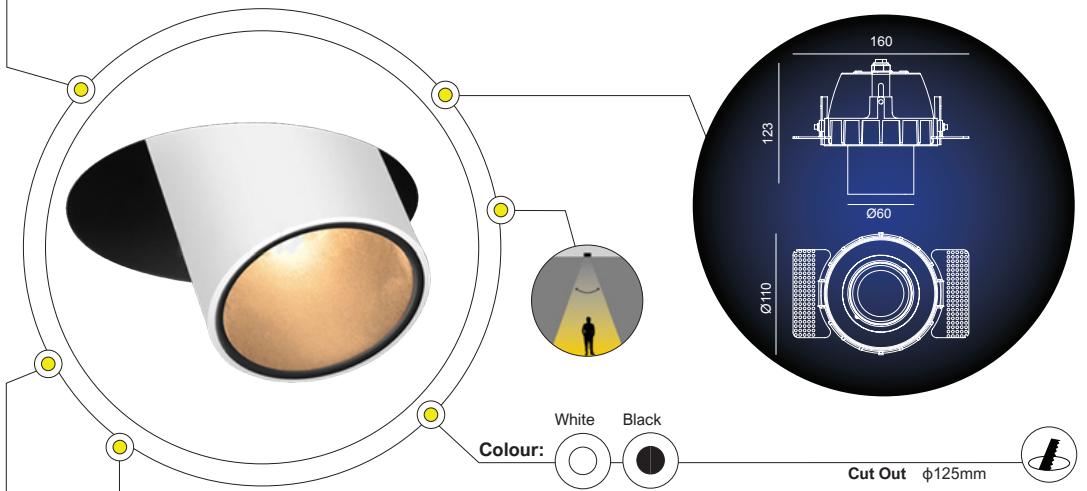

+ IP 20



LOA

5 YRS

ldt



PHYSICAL DATA

FEATURES

- Material: Aluminium
- The FAVOR is an excellent choice for your lighting requirements; the range is great for accent lighting; with both narrow and wide beam angles. The range includes square and round recessed and surface mounted options, adjustable and rotatable options, pendant lights, surface spotlights as well as track applications
- Adjustable, TRIAC dimmable

OPTIONS & ACCESSORIES

- On/Off, DALI and DIM 0/1-10V dimming options available
- Round, square and trimless options available

MOUNTING

Recessed, skimmed in

APPLICATION AREAS: Indoor, Commercial, Residential, Retail, Hospitality

TECHNICAL DATA

LF178412EDT

LAMP	LED
TOTAL POWER (W)	16.4W
SYSTEM OUTPUT (LM)	537LM
CCT (K)	2700 / 3000 / 4000K
CRI (Ra)	90
BEAM ANGLE	18° / 32°

OPERATING VOLTAGE-VAC	100-277V
SOURCE POWER (W)	18W
SOURCE OUTPUT (LM)	1465LM
CURRENT (MA)	500MA
DIMMING RANGE	30-100%
WEIGHT (KG)	0.78KG
DIMENSIONS	160 x 110 x 123mm
CUT OUT	D:125mm



- CD / KLM
- C0 - C180
 - C90 - C270

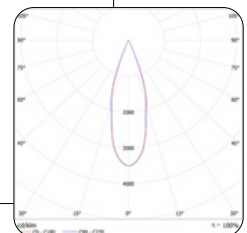

E&OE MAY OCCUR

➤ DOWNLIGHTS – RECESSED

COMMERCIAL & ARCHITECTURAL

DOWNLIGHTS – RECESSED – COMMERCIAL & ARCHITECTURAL



Project Brommerkei / Photography Archigraphy

FOCUS S14

LED RECESSED DOWNLIGHT



Colour:



Cut Out: ϕ 70mm

+ IP 54



LOA

5 YRS

ldt



PHYSICAL DATA

FEATURES

- Material: Aluminium
- TRIAC Dimmable
- The FOCUS is an elegant downlight that answers all lighting requirements; with adjustable, direct and trimless versions. The light source is placed deep within the luminaire providing a perfect anti-glare effect
- The FOCUS has an inner ring that can be changed and they offer a lovely selection of covers, suited to any space
- The Softening Lens is standard - others are optional

OPTIONS & ACCESSORIES

- The Focus S 9W and Focus S+ 12W are available
- On/Off, DALI and 0/1-10V dimming options available
- Focus S DO 13W Turnable White-App version available
- Honeycomb, Straight Grained and Cridding Glass lenses available
- Interchangeable covers available on order (colours above)

MOUNTING: Recessed

APPLICATION AREAS: Indoor, Outdoor, Commercial, Residential, Retail, Hospitality, Galleries

TECHNICAL DATA

LF112419EDT

LAMP	LED
TOTAL POWER (W)	12.25W
SYSTEM OUTPUT (LM)	618LM
CCT (K)	2700 / 3000 / 3500 / 4000K
CRI (Ra)	90
BEAM ANGLE	20° / 27° / 36°
OPERATING VOLTAGE-VAC	220-240V
SOURCE POWER (W)	14.5W
CURRENT (MA)	350MA
DIMMING RANGE	30-100%
FLICKER FACTOR	103.27HZ / 0.5%
DIMENSIONS	D: ϕ 80 x H:60mm
CUT OUT	D: ϕ 70mm

FOCUS FRAME LF001907



Colours - Black or White
D: ϕ 80 x H:16.5mm

FOCUS COVER LF001805



Colours - as per Specsheets
D: ϕ 59.6 x H:13mm

STRAIGHT GRAINED LENS LF001909GG



D: ϕ 47.5 x H:3mm

CRIDDING LENS LF001908CG



D: ϕ 47.5 x H:3mm

HONEYCOMB LENS LF001548B



D: ϕ 47.5 x H:3mm

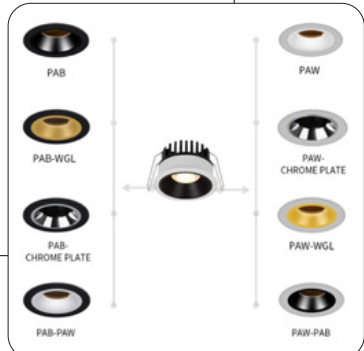

E&OE MAY OCCUR

NIC S

LED RECESSED
DOWNLIGHT

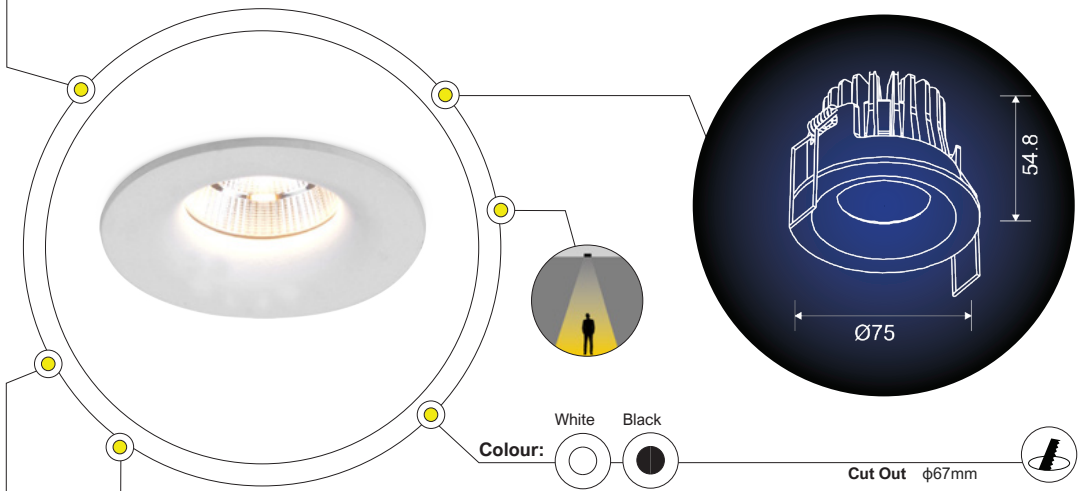

+ IP 20



LOA



3 YRS

ldt

PHYSICAL DATA

FEATURES

- Material: Aluminium
- The NIC is the most extensive product family in the FLUA collection, answering almost all your lighting requirements. The range includes round and square, recessed, round surface lights, adjustable and fixed options as well as square and rectangular plates allowing one to mount the NIC in a series of either one, two or three downlights

OPTIONS & ACCESSORIES

- DALI, TRIAC DIM (dim to warm) and Dim 01/-10V dimming available

MOUNTING

Recessed

APPLICATION AREAS

Indoor, Commercial, Residential, Retail, Hospitality

TECHNICAL DATA

LF102024EA

LAMP	LED
TOTAL POWER (W)	6.7W
SYSTEM OUTPUT (LM)	477LM
CCT (K)	3000K
CRI (Ra)	90
BEAM ANGLE	20°
OPERATING VOLTAGE-VAC	220-240V
SOURCE POWER (W)	8W
SOURCE OUTPUT (LM)	623LM
CURRENT (MA)	350MA
FLICKER FACTOR	99.83HZ / 1.55%
WEIGHT	0.3KG
DIMENSIONS	D:Ø75 x H:54.8mm
CUT OUT	D:Ø67mm

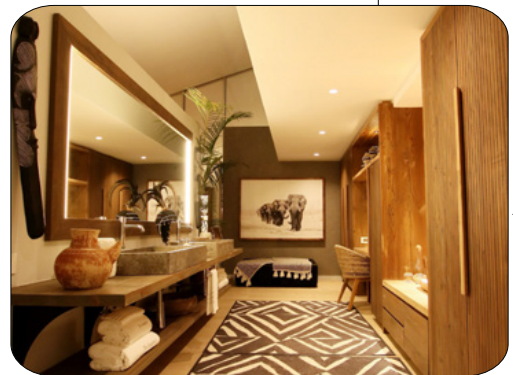

Project: Molino, Cape Town / Lighting Design: Dominique Poroniti

- CD / KLM
- C0 - C180
 - C90 - C270

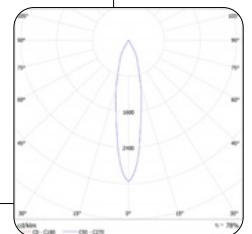

E&OE MAY OCCUR

NIC S AD

LED RECESSED
DOWNLIGHT

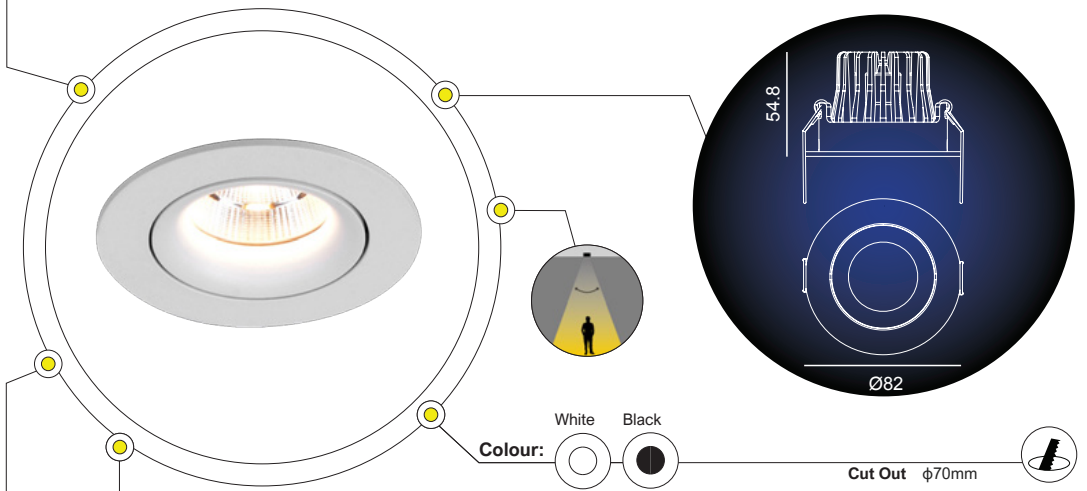

+ IP 20



LOA

3 YRS

ldt

PHYSICAL DATA

FEATURES

- Material: Aluminium
- The NIC is the most extensive product family in the FLUA collection, answering almost all your lighting requirements. The range includes round and square, recessed, round surface lights, adjustable and fixed options as well as square and rectangular plates allowing one to mount the NIC in a series of either one, two or three downlights
- Adjustable

OPTIONS & ACCESSORIES

- DALI, TRIAC DIM (dim to warm) and Dim 01/-10V dimming available

MOUNTING

Recessed

APPLICATION AREAS

Indoor, Commercial, Residential, Retail, Hospitality

TECHNICAL DATA

LF102025EA

LAMP	LED
TOTAL POWER (W)	6.7W
SYSTEM OUTPUT (LM)	477LM
CCT (K)	2700 / 3000 / 4000K
CRI (Ra)	90
BEAM ANGLE	31° / 23° / 47°
OPERATING VOLTAGE-VAC	220-240V
SOURCE POWER (W)	7.9W
SOURCE OUTPUT (LM)	623LM
CURRENT (MA)	500MA
FLICKER FACTOR	99.83HZ / 1.55%
WEIGHT	0,23KG
DIMENSIONS	D:φ82 x H:54.8mm
CUT OUT	D:φ70mm

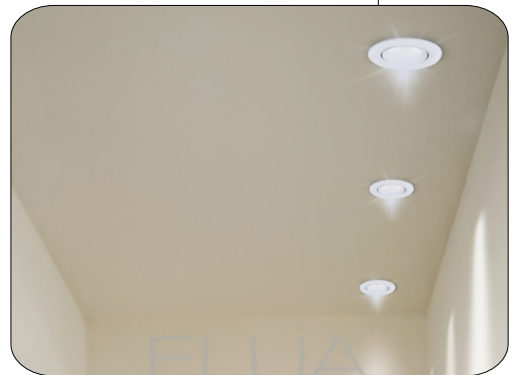

- CD / KLM
- C0 - C180
 - C90 - C270

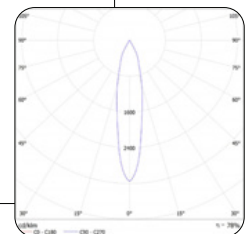

E&OE MAY OCCUR

NIC M

LED RECESSED DOWNLIGHT

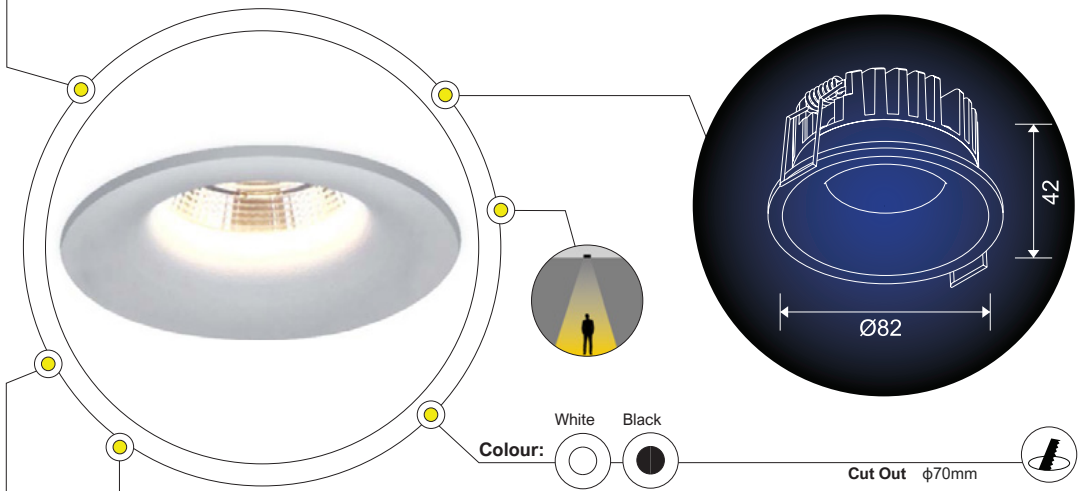

+ IP 20



LOA

3 YRS

ldt

PHYSICAL DATA

FEATURES

- Material: Aluminium
- The NIC is the most extensive product family in the FLUA collection, answering almost all your lighting requirements. The range includes round and square, recessed, round surface lights, adjustable and fixed options as well as square and rectangular plates allowing one to mount the NIC in a series of either one, two or three downlights

OPTIONS & ACCESSORIES

- DALI, TRIAC DIM, Dim 01/-10V dimming available
- LF156012EAW3K with longer heatsink available: D:φ82 x H:68mm
- Square version available

MOUNTING: Recessed

APPLICATION AREAS: Indoor, Commercial, Residential, Retail, Hospitality

TECHNICAL DATA

LF156012BEA

LAMP	LED
TOTAL POWER (W)	9.35W
SYSTEM OUTPUT (LM)	698LM
CCT (K)	2700 / 3000 / 4000K
CRI (Ra)	90
BEAM ANGLE	31° / 23° / 47°
OPERATING VOLTAGE-VAC	220-240V
SOURCE POWER (W)	11.12W
SOURCE OUTPUT (LM)	1009LM
CURRENT (MA)	500MA
FLICKER FACTOR	102.74HZ / 0.55%
WEIGHT	0.23KG
DIMENSIONS	D:φ82 x H:42mm
CUT OUT	D:φ70mm



Project 169 - on Main

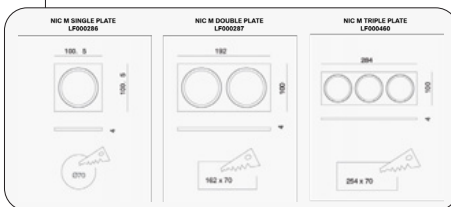

- CD / KLM
- C0 - C180
 - C90 - C270

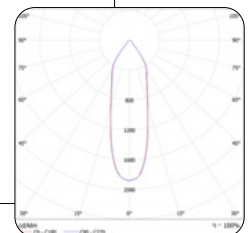

E&OE MAY OCCUR

NIC M AD

LED RECESSED DOWNLIGHT

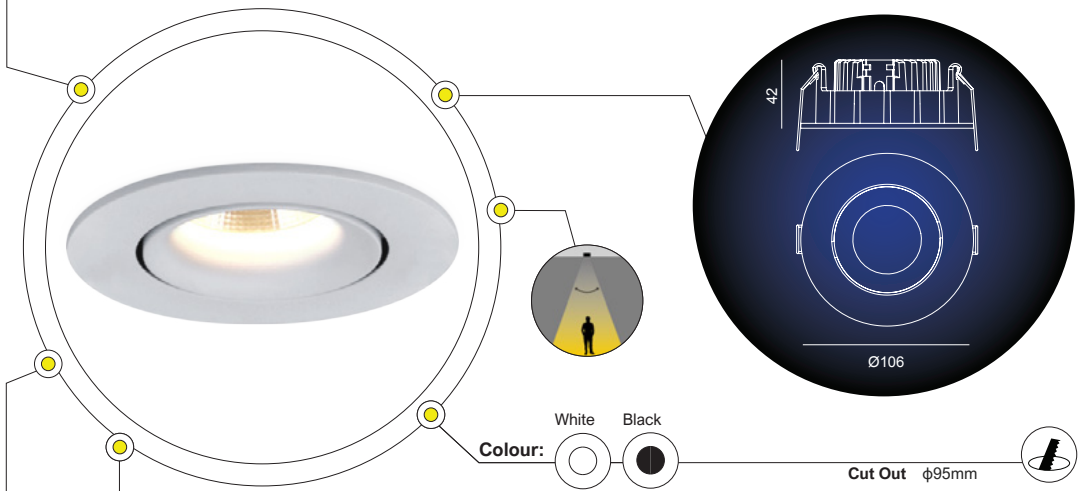

+ IP 20



LOA

3 YRS

ldt



PHYSICAL DATA

FEATURES

- Material: Aluminium
- The NIC is the most extensive product family in the FLUA collection, answering almost all your lighting requirements. The range includes round and square, recessed, round surface lights, adjustable and fixed options as well as square and rectangular plates allowing one to mount the NIC in a series of either one, two or three downlights
- Adjustable

OPTIONS & ACCESSORIES

- DALI, TRIAC DIM, Dim 01/-10V dimming available
- Square version available

MOUNTING

Recessed

APPLICATION AREAS

Indoor, Commercial, Residential, Retail, Hospitality

TECHNICAL DATA

LF178912BEA

LAMP	LED
TOTAL POWER (W)	9.35W
SYSTEM OUTPUT (LM)	698LM
CCT (K)	2700 / 3000 / 4000K
CRI (Ra)	90
BEAM ANGLE	31° / 23° / 47°
OPERATING VOLTAGE-VAC	220-240V
SOURCE POWER (W)	11.12W
SOURCE OUTPUT (LM)	1009LM
CURRENT (MA)	500MA
FLICKER FACTOR	102.74HZ / 0.55%
WEIGHT	0.23KG
DIMENSIONS	D:φ106 x H:42mm
CUT OUT	D:φ95mm

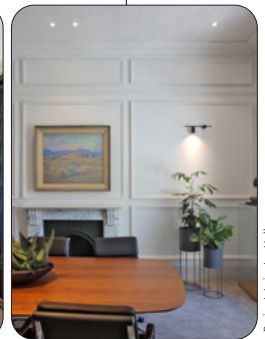
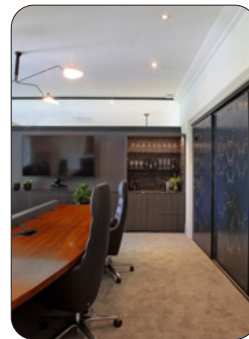

Project: Ienster Hall

- CD / KLM
- C0 - C180
 - C90 - C270

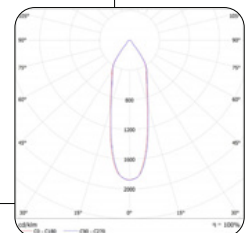

E&OE MAY OCCUR

NIC L

LED RECESSED DOWNLIGHT

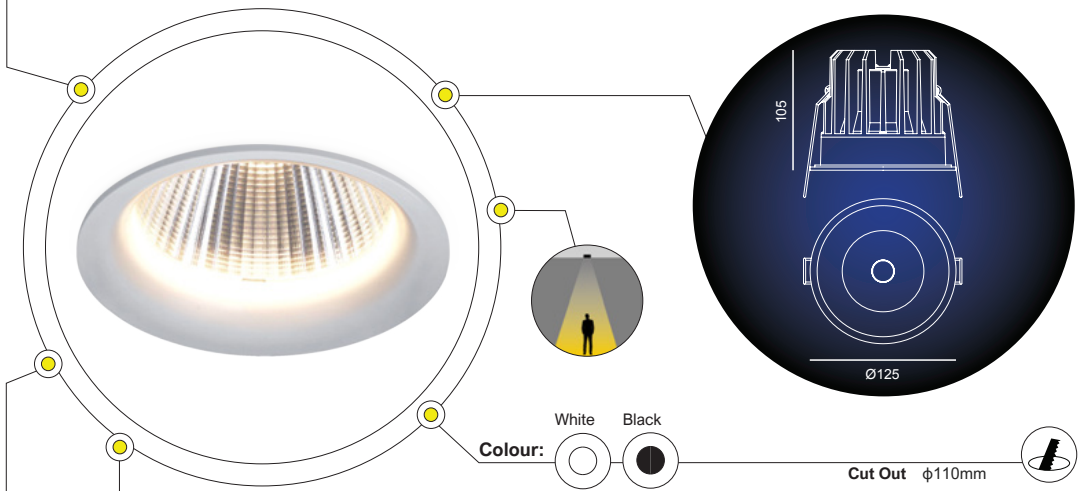

Cut Out ϕ 110mm



+ IP 20



LOA

3 YRS

ldt

PHYSICAL DATA

FEATURES

- Material: Aluminium
- The NIC is the most extensive product family in the FLUA collection, answering almost all your lighting requirements. The range includes round and square, recessed, round surface lights, adjustable and fixed options as well as square and rectangular plates allowing one to mount the NIC in a series one, two or three

OPTIONS & ACCESSORIES

- DALI, TRIAC DIM (dim to warm) and Dim 01/-10V dimming available for selection

MOUNTING

Recessed

APPLICATION AREAS

Indoor, Commercial, Residential, Retail, Hospitality

TECHNICAL DATA

LF196015EA

LAMP	LED
TOTAL POWER (W)	38W
SYSTEM OUTPUT (LM)	2973LM
CCT (K)	2700 / 3000 / 3500 / 4000K
CRI (Ra)	90
BEAM ANGLE	26° / 38°
OPERATING VOLTAGE-VAC	220-240V
SOURCE POWER (W)	45W
SOURCE OUTPUT (LM)	3819LM
CURRENT (MA)	1050MA
WEIGHT (KG)	0.63KG
DIMENSIONS	D: ϕ 125 x H:105mm
CUT OUT	D: ϕ 110mm



Project: House Fischer / Lighting Design: Dominique Peronetti

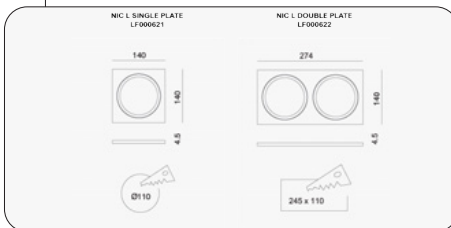

- CD / KLM
- C0 - C180
 - C90 - C270

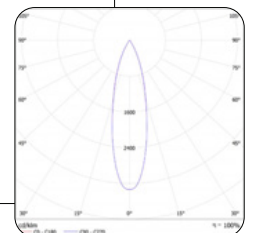

E&OE MAY OCCUR

NIC L AD

LED RECESSED DOWNLIGHT

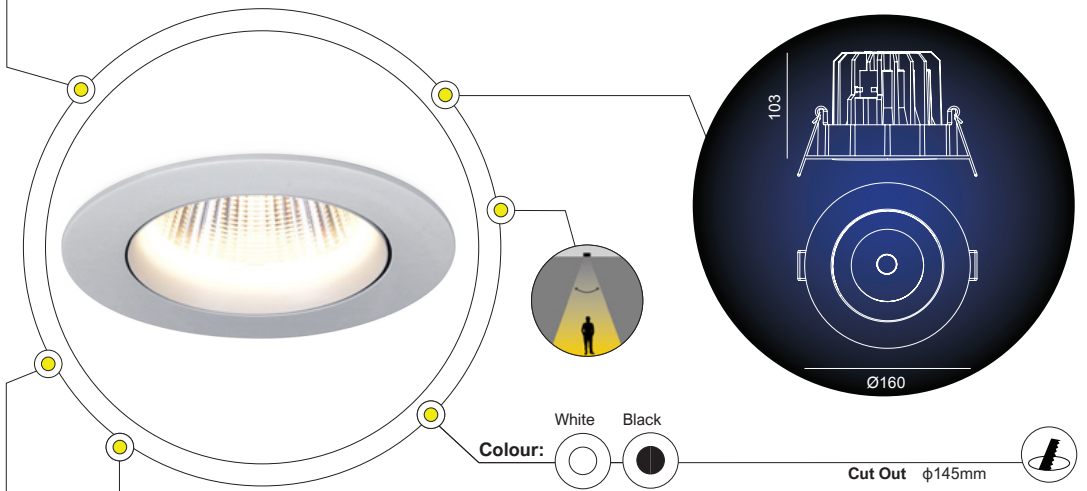

+ IP 20



LOA

3 YRS

ldt

PHYSICAL DATA

FEATURES

- Material: Aluminium
- The NIC is the most extensive product family in the FLUA collection, answering almost all your lighting requirements. The range includes round and square, recessed, round surface lights, adjustable and fixed options as well as square and rectangular plates allowing one to mount the NIC in a series one, two or three
- Adjustable with TRIAC Dimming

OPTIONS & ACCESSORIES

- DALI and DIM 0/1-10V dimming for selection

MOUNTING

Recessed

APPLICATION AREAS

Indoor, Commercial, Residential, Retail, Hospitality

TECHNICAL DATA

LF106719EDT

LAMP	LED
TOTAL POWER (W)	24.2W
SYSTEM OUTPUT (LM)	2100LM
CCT (K)	2700 / 3000 / 3500 / 4000K
CRI (Ra)	90
BEAM ANGLE	26°
OPERATING VOLTAGE-VAC	220-240V
SOURCE POWER (W)	25.2W
CURRENT (MA)	700MA
DIMMING RANGE	30-100%
FLICKER FACTOR	100.33HZ / 11.21%
DIMENSIONS	D:φ160 x H:103mm
CUT OUT	D:φ145mm

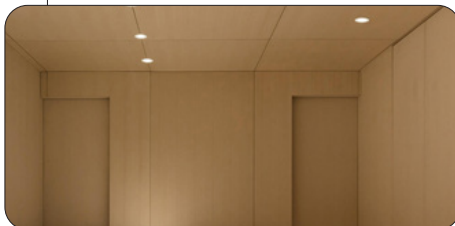
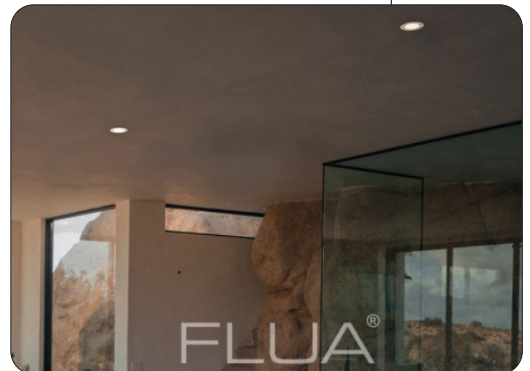

- CD / KLM
- C0 - C180
 - C90 - C270

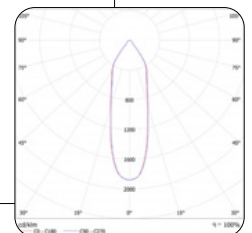

E&OE MAY OCCUR

NIC S+ DEEP

LED RECESSED DOWNLIGHT

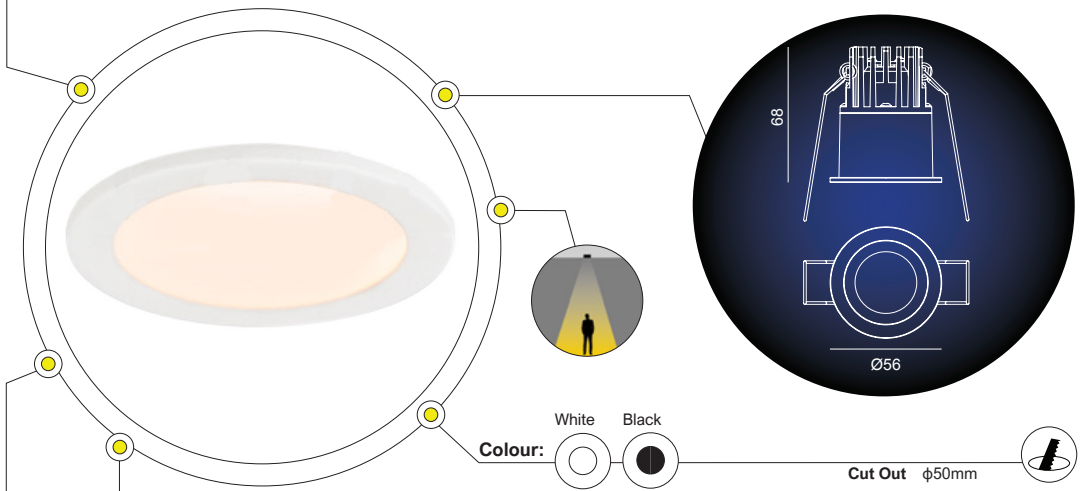

+ IP 20



LOA

3 YRS

ldt

PHYSICAL DATA

FEATURES

- Material: Aluminium
- The NIC is the most extensive product family in the FLUA collection, answering almost all your lighting requirements
- The range includes round and square, recessed, round surface lights, adjustable and fixed options as well as square and rectangular plates allowing one to mount the NIC in a series one, two or three
- TRIAC Dimming

OPTIONS & ACCESSORIES

- DALI and Dim 01/-10V dimming available for selection
- 7.4W option available

MOUNTING

Recessed

APPLICATION AREAS

Indoor, Commercial, Residential, Retail, Hospitality

TECHNICAL DATA

LF176212EDT

LAMP	LED
TOTAL POWER (W)	9.12W
SYSTEM OUTPUT (LM)	508LM
CCT (K)	2700 / 3000 / 3500 / 4000K
CRI (Ra)	90
BEAM ANGLE	25° / 36°
OPERATING VOLTAGE-VAC	220-240V
SOURCE POWER (W)	11.12W
SOURCE OUTPUT (LM)	957LM
DIMMING RANGE	30-100%
FLICKER FACTOR	100.67HZ / 2.13%
WEIGHT	0,21KG
DIMENSIONS	D:φ56 x H:68mm
CUT OUT	D:φ50mm



S / S+DEEP 1



S / S+DEEP 2



S / S+DEEP 3

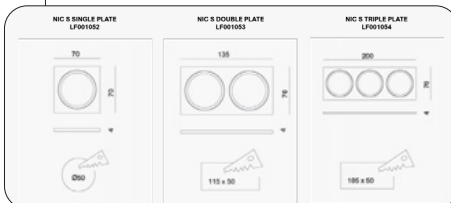
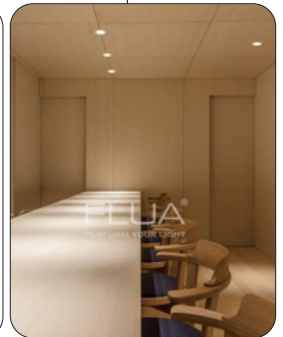

CD / KLM

● C0 - C180

● C90 - C270

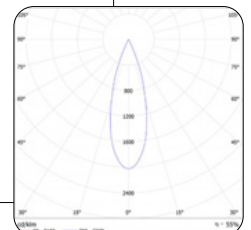

E&O MAY OCCUR

VISOR S

LED RECESSED
DOWNLIGHT

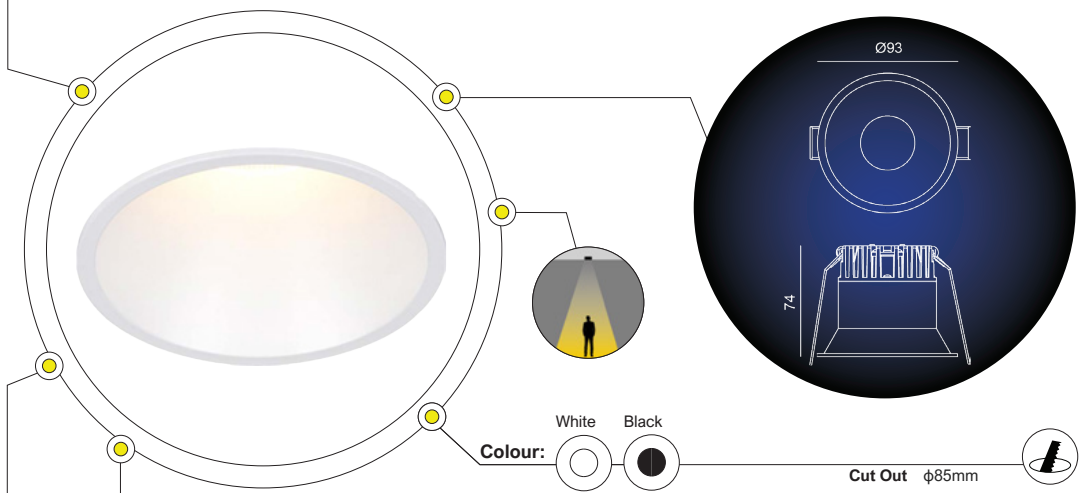

+ IP 20



LOA

3 YRS

ldt

PHYSICAL DATA

FEATURES

- Material : Aluminium
- The VISOR family offers trimless or recessed downlight options in square or round with various wattages and beam angles
- Low flicker

OPTIONS & ACCESSORIES

- DALI and TRIAC dimming options available

- CCT (K) 3500K available as a special order

MOUNTING

Recessed

APPLICATION AREAS

Indoor, Commercial, Residential, Retail, Hospitality

TECHNICAL DATA

LF189212EA

LAMP	LED
TOTAL POWER (W)	9.12W
SYSTEM OUTPUT (LM)	667LM
CCT (K)	2700 / 3000 / 4000K
CRI (Ra)	90
BEAM ANGLE	24°

OPERATING VOLTAGE-VAC	220-240V
SOURCE POWER (W)	10.7W
SOURCE OUTPUT (LM)	957LM
FLICKER FACTOR	102.74HZ / 0.55%
WEIGHT (KG)	0.33KG
DIMENSIONS	D:φ93 x H:74mm
CUT OUT	D:φ85mm



- CD / KLM
- C0 - C180
 - C90 - C270

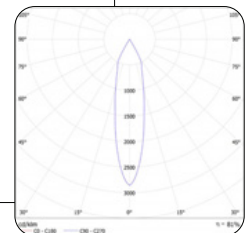

E&OE MAY OCCUR

VISOR M

LED RECESSED
DOWNLIGHT

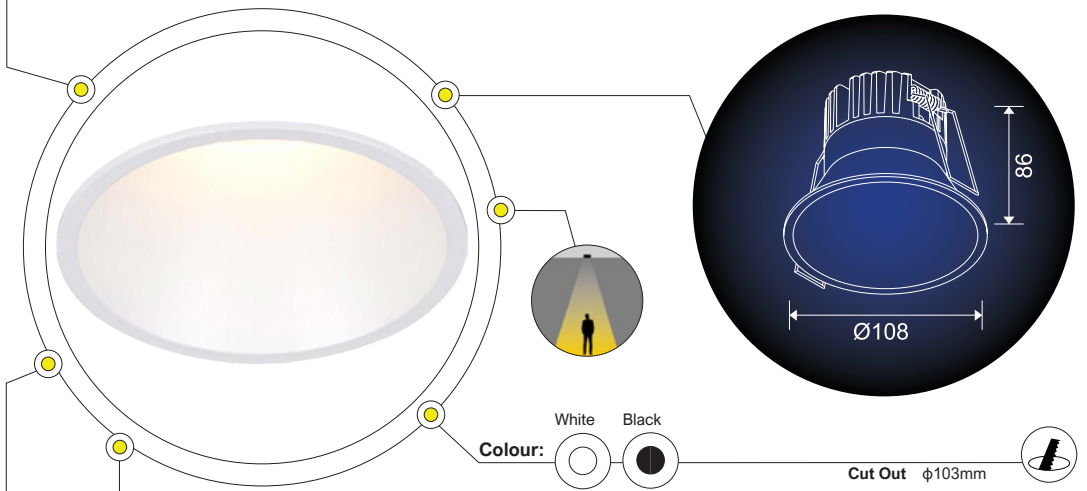

+ IP 20



LOA

3 YRS

ldt

PHYSICAL DATA

FEATURES

- Material : Aluminium
- The VISOR family offers trimless or recessed downlight options in square or round with various wattages and beam angles
- Low flicker
- Driver: On/Off

- DALI and TRIAC DIM dimming options available
- Round / Square Trims available
- Trimless version available

MOUNTING

Recessed

APPLICATION AREAS

Indoor, Commercial, Residential, Retail, Hospitality

OPTIONS & ACCESSORIES

TECHNICAL DATA

LF189312EA

LAMP	LED
TOTAL POWER (W)	13.7W
SYSTEM OUTPUT (LM)	1037LM
CCT (K)	2700 / 3000 / 3500 / 4000K
CRI (Ra)	90
BEAM ANGLE	30° / 20° / 58°

OPERATING VOLTAGE-VAC	220-240V
SOURCE POWER (W)	16.1W
SOURCE OUTPUT (LM)	1465LM
FLICKER FACTOR	100HZ / 1.63%
WEIGHT (KG)	0.34KG
DIMENSIONS	D:φ108 x H:86mm
CUT OUT	D:φ103mm



- CD / KLM
- C0 - C180
 - C90 - C270

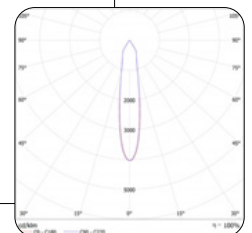

E&OE MAY OCCUR

STUDIO

CEILING LIGHT

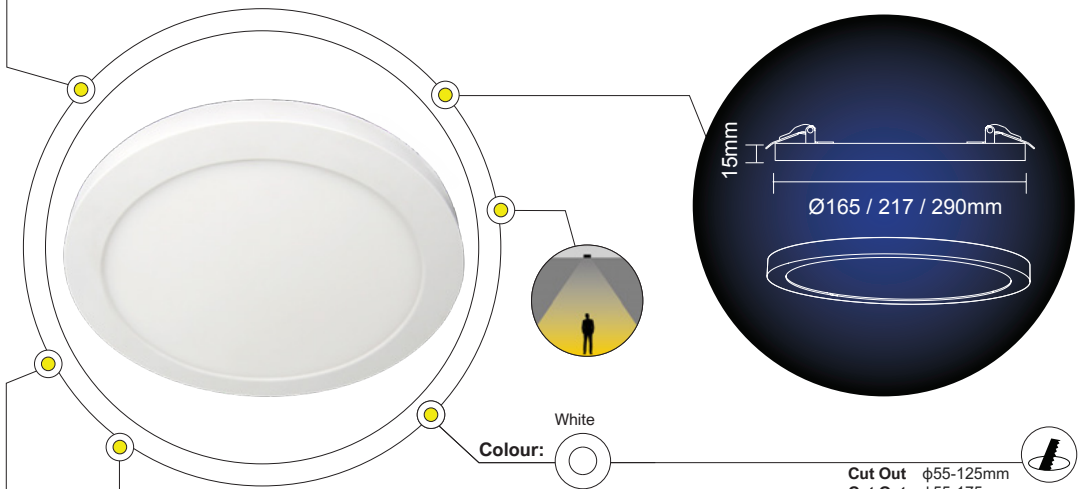

Cut Out ϕ 55-125mm
Cut Out ϕ 55-175mm
Cut Out ϕ 60-250mm

+ IP 54



LOA

2 YRS

ldt

PHYSICAL DATA

FEATURES

- Material: Polycarbonate housing with polystyrene diffuser
- Adjustable stainless steel mounting bracket allowing mounting in cut-outs of 55-125mm for the 12W
- Adjustable stainless steel mounting bracket allowing mounting in cut-outs of 55-175mm for the 18W
- Adjustable stainless steel mounting bracket allowing mounting in cut-outs of 60-250mm for the 24W
- TRIAC dimmable luminaire
- CCT selectable between 3000K, 4000K and 6500K

using switch on the back of the fitting

- Comes with magnet to allow easy clip-on mounting of accessory trims
- Pre-wired with 170mm flex
- Suitable for switching by PIR, Microwave or Photocell

MOUNTING: Recessed or Surface

APPLICATION AREAS: Indoor, Commercial, Hospitality Retail, Educational Sector, Hospitals

TECHNICAL DATA

	RSD12CCT3M-01	RSD18CCT3M-01	RSD24CCT3M-01
LAMP	LED	LED	LED
TOTAL POWER (W)	12.5 / 12.8 / 12.6W	18.1 / 18.6 / 18.2W	22.8 / 23.5 / 22.7W
SYSTEM OUTPUT (LM)	970 / 1080 / 990LM	1620 / 1770 / 1590LM	1820 / 2100 / 1870LM
EFFICACY (LM/W)	77 / 84 / 79	89 / 95 / 87	80 / 90 / 83
CCT (K)	3000 / 4000 / 6500K	3000 / 4000 / 6500K	3000 / 4000 / 6500K
CRI (RA)	80	80	80
BEAM ANGLE	110°	110°	110°
OPERATING VOLTAGE	220-240V	220-240V	220-240V
OPERATING TEMP (°C)	-20°C to +40°C	-20°C to +40°C	-20°C to +40°C
RATED LIFE (HRS)	20 000HRS	20 000HRS	20 000HRS
POWER FACTOR	0.9	0.9	0.9
WEIGHT (KG)	0.2KG	0.35KG	0.6KG
ILLUM @ 1M (LUX)	330 / 370 / 340	630 / 730 / 650	630 / 730 / 650
DIMENSIONS	D: ϕ 165 x H:15mm	D: ϕ 217 x H:15mm	D: ϕ 290 x H:15mm
CUT OUT	D: ϕ 55-125mm	D: ϕ 55-175mm	D: ϕ 60-250mm

Reverse view of the STUDIO downlight



RSD 12 / 24 TRIM-04 & RSD 12 / 24 TRIM-13

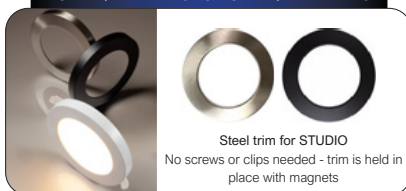

CD / KLM

- C0 - C180
- C90 - C270

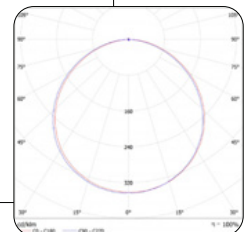

E&OE MAY OCCUR

VIRTUE

LED RECESSED
DOWNLIGHT

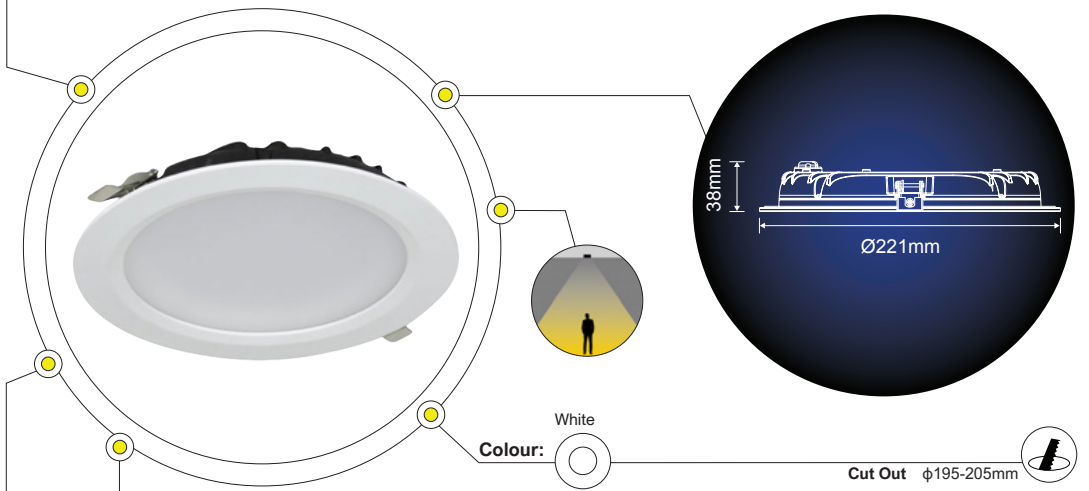

+ IP
54



LOA

5 YRS

ldt

PHYSICAL DATA

FEATURES

- Material: Die-cast aluminium housing with polycarbonate diffuser
- Luminaire offers optimum light transmission with good uniformity whilst reducing eye discomfort glare
- Slim profile allowing easy installation in ceilings with shallow void and wide flange trim helps cover poorly cut or existing cut-outs
- Suitable for use with R3EMPk-PSU emergency pack and HED2040-D DALI, 1-10V, Push Dim driver

- Suitable for switching by PIR, Microwave or Photocell

FEATURES

- Surface Mount Can available (RMPSMK-01)

MOUNTING: Recessed

APPLICATION AREAS

Indoor, Commercial, Hospitality Retail, Educational Sector, Hospitals

TECHNICAL DATA

RVR1840-01

RVR2440-01

LAMP	LED	LED
TOTAL POWER (W)	18W	23.7W
SYSTEM OUTPUT (LM)	2270LM	2990LM
EFFICACY (LM/W)	126	126
CCT (K)	4000K	4000K
CRI (RA)	80	80
BEAM ANGLE	100°	100°
OPERATING VOLTAGE-VAC	220-240V	220-240V
OPERATING TEMP (°C)	-20°C to +40°C	-20°C to +40°C
RATED LIFE (HRS)	50 000HRS	50 000HRS
POWER FACTOR	0.95	0.95
WEIGHT (KG)	06KG	0.6KG
ILLUM @ 1M (LUX)	920	1200
DIMENSIONS	D:φ221 x H:38mm	D:φ221 x H:38mm
CUT OUT	D:φ195-205mm	D:φ195-205mm

CD / KLM

● C0 - C180

● C90 - C270

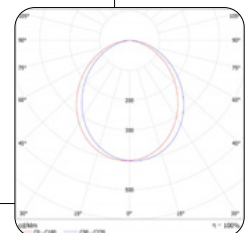

E&OE MAY OCCUR

MIRA DUAL WATTAGE

LED RECESSED
DOWNLIGHT

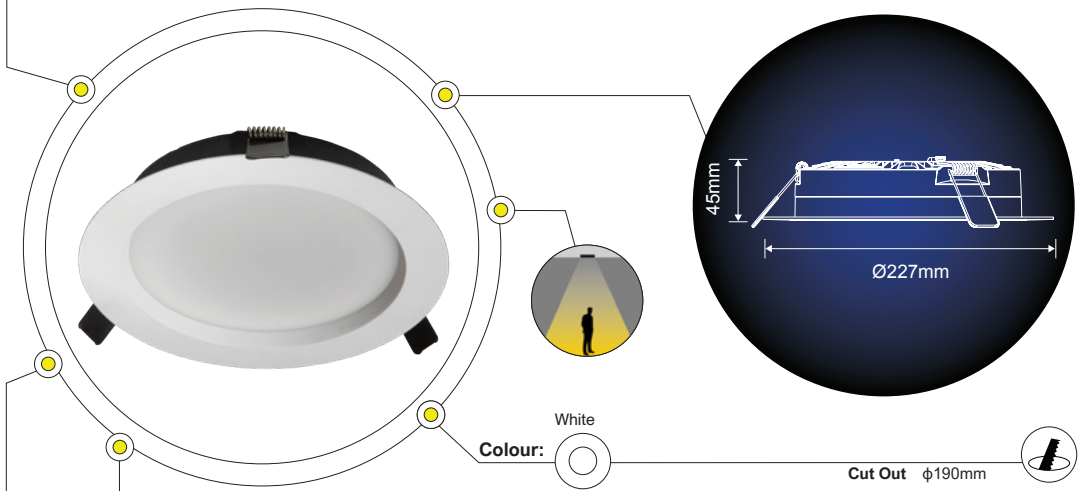

+ IP 44



LOA

3 YRS

ldt

COLOUR SELECTABLE

PHYSICAL DATA

FEATURES

- Construction: Die-cast aluminium powder coated body and trim, TPA rated polycarbonate diffuser, Steel spring clips with PVA covers
- Integrated switch allows selection between two wattages and four CCT's
- Complete with dimmable driver for use with selected leading and trailing edge dimmers
- Slim die-cast body aids installation in shallow ceiling voids
- Utilises high-quality LM80 tested SMD LEDs

FEATURES

- Suitable for switching by PIR, Microwave or Photocell
- Emergency options available for selection
- Extra-wide extension trim accessory available (RMP280TRIM-01)
- Surface mount accessory available (RMPSMK-01)

MOUNTING: Recessed or Surface

APPLICATION AREAS: Indoor, Commercial, Hospitality Retail, Educational Sector, Hospitals

TECHNICAL DATA

RMR1824X0-01

RMR3040X0-01

LAMP	LED	LED
TOTAL POWER (W)	18W & 24W	30W & 40W
SYSTEM OUTPUT (LM)	1850-2010 & 2360-2630LM	3210-3420 & 4020-4340LM
EFFICACY (LM/W)	98-109 & 92-105	107-115 & 101-111
CCT (K)	3000 & 4000 & 5000 & 6500K	3000 & 4000 & 5000 & 6500K
CRI (RA)	80	80
BEAM ANGLE	110°	110°
OPERATING VOLTAGE-VAC	220-240V	220-240V
OPERATING TEMP (°C)	-20°C to +40°C	-20°C to +40°C
RATED LIFE (HRS)	30 000HRS	30 000HRS
POWER FACTOR	0.9	0.9
ILLUM @ 1M (LUX)	690-750 & 870-980	1200-1270 & 1500-1610
IMPACT RATING (IK)	07	07
WEIGHT (KG)	0.97KG	1.01KG
DIMENSIONS	D:φ227 x H:45mm	D:φ227 x H:45mm
CUT OUT	D:φ190mm	D:φ190mm

CD / KLM

● C0 - C180

● C90 - C270

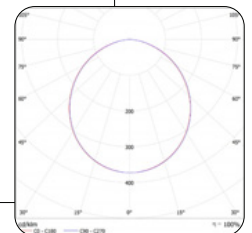

E&OE MAY OCCUR

TAYLOR

LED RECESSED DOWNLIGHT

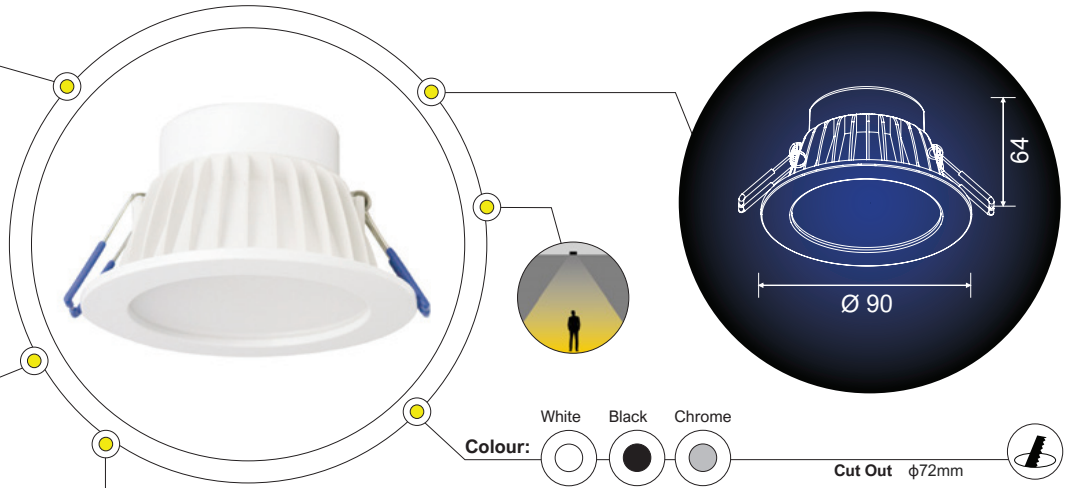

+ IP 44



LOA

3 YRS

ldt

COLOUR SELECTABLE

PHYSICAL DATA

FEATURES

- Material: Plastic-coated die-cast aluminium body with opal polycarbonate diffuser
- Complete downlight kit with slim white and brushed chrome trims included to match or contrast most decors
- Pre-wired fitting with 0.25m of flex and 2 pole push-in spring terminal connector block with integral cable clamp facility
- Luminaire provides a soft light for low glare whilst allowing maximum lumen transmission

- The body provides maximum thermal conductivity to dissipate heat for long LED and driver life

OPTIONS & ACCESSORIES

- TRIAC dimming option available

MOUNTING: Recessed

APPLICATION AREAS: Indoor, Commercial, Retail, Hospitality, Public Buildings

TECHNICAL DATA

LRD287

LAMP	LED
TOTAL POWER (W)	7W
SYSTEM OUTPUT (LM)	600 / 650 / 620 LM
EFFICACY (LM/W)	85 / 92 / 91
CCT (K)	3000 / 4000 / 6500K
CRI (Ra)	80
BEAM ANGLE	100°
OPERATING VOLTAGE-VAC	220-240V
CURRENT (MA)	170MA
RATED LIFE (HRS)	30 000HRS
ILLUM @ 1M (LUX)	250 / 300 / 270LX
POWER FACTOR	0.9
R9 VALUE	6 / 19 / - 4
UGR	31
MAC ADAM STEP	2.3 / 5.5 / 1.2
OPERATING TEMP °C	-20°C to +40°C
WEIGHT (KG)	0.22 Kg
DIMENSIONS	D:φ90 x H:64mm
CUT OUT	D:φ72mm

- CD / KLM
- C0 - C180
 - C90 - C270

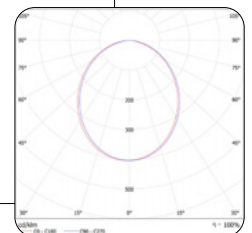

E&OE MAY OCCUR

WANA RO AD

LED RECESSED DOWNLIGHT

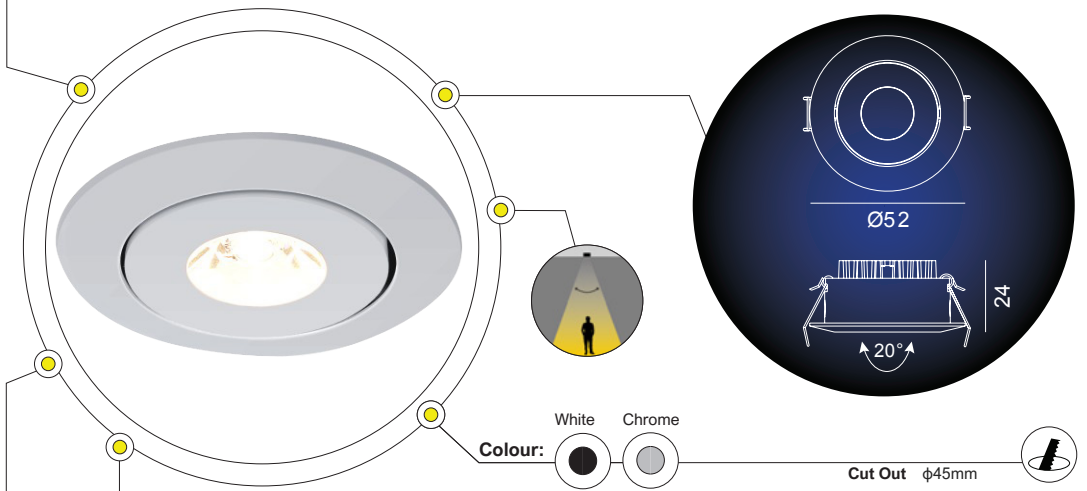

+ IP 40



LOA

3 YRS

ldt



PHYSICAL DATA

FEATURES

- Material: Aluminium
- The WANA RO AD is a low-power recessed ceiling light
- This luminaire is perfect for installation in a ceiling or showcase
- Adjustable

MOUNTING

Recessed

APPLICATION AREAS

Indoor, Commercial, Residential, Retail, Hospitality

TECHNICAL DATA

LF148211A

LAMP	LED
TOTAL POWER (W)	2.2W
SYSTEM OUTPUT (LM)	170LM
CCT (K)	2700 / 3000 / 4000K
CRI (Ra)	80
BEAM ANGLE	20°
OPERATING VOLTAGE-VAC	100-240V
SOURCE POWER (W)	4.2W
CURRENT (MA)	700MA
FLICKER FACTOR	1935.48HZ / 6.15%
WEIGHT (KG)	0.09KG
DIMENSIONS	D:φ52 x H:24mm
CUT OUT	D:φ45mm



- CD / KLM
- C0 - C180
 - C90 - C270

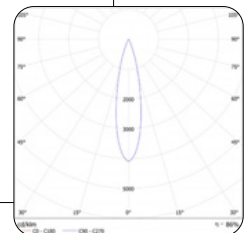

E&OE MAY OCCUR

RAY AISI316

LED RECESSED
DOWNLIGHT

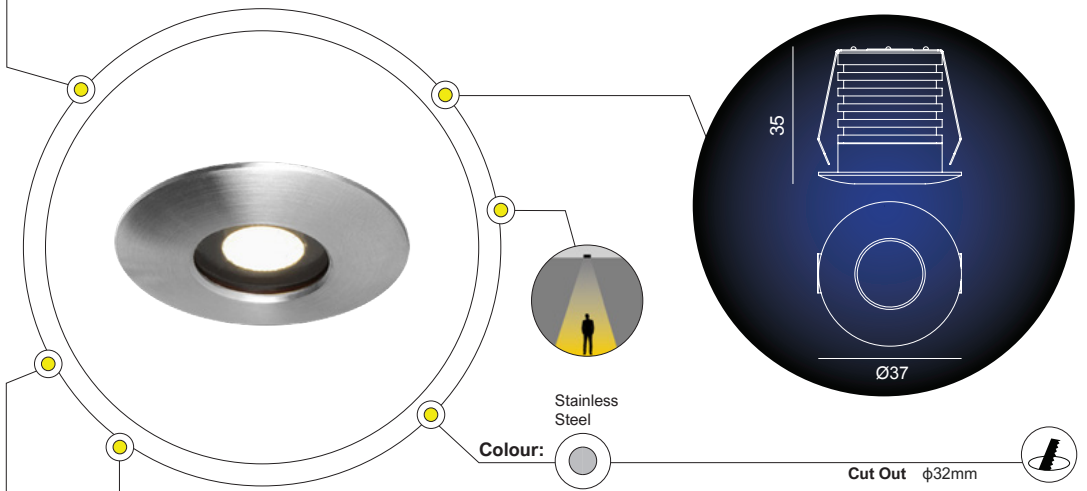

+ IP 65



LOA



ldt

PHYSICAL DATA

FEATURES

- Material: Stainless Steel
- The RAY is a low-power spotlight with a narrow beam angle
- Driver: On/Off

MOUNTING

Recessed

APPLICATION AREAS

Indoor, Commercial, Residential, Retail, Hospitality

TECHNICAL DATA

LF136511A

LAMP	LED
TOTAL POWER (W)	2.2W
SYSTEM OUTPUT (LM)	121LM
CCT (K)	3000 / 3500 / 4000K
CRI (Ra)	80
BEAM ANGLE	15° / 25°
OPERATING VOLTAGE-VAC	100-240V
SOURCE POWER (W)	4.2W
SOURCE OUTPUT (LM)	426LM
CURRENT (MA)	700MA
FLICKER FACTOR	1935.48HZ/ 6.15%
WEIGHT (KG)	0.09KG
DIMENSIONS	D:φ37 x H:55mm
CUT OUT	D:φ32mm



CD / KLM

● C0 - C180

● C90 - C270

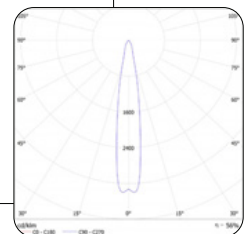

E&OE MAY OCCUR

SLIM

LED RECESSED DOWNLIGHT

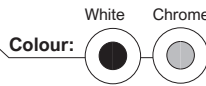
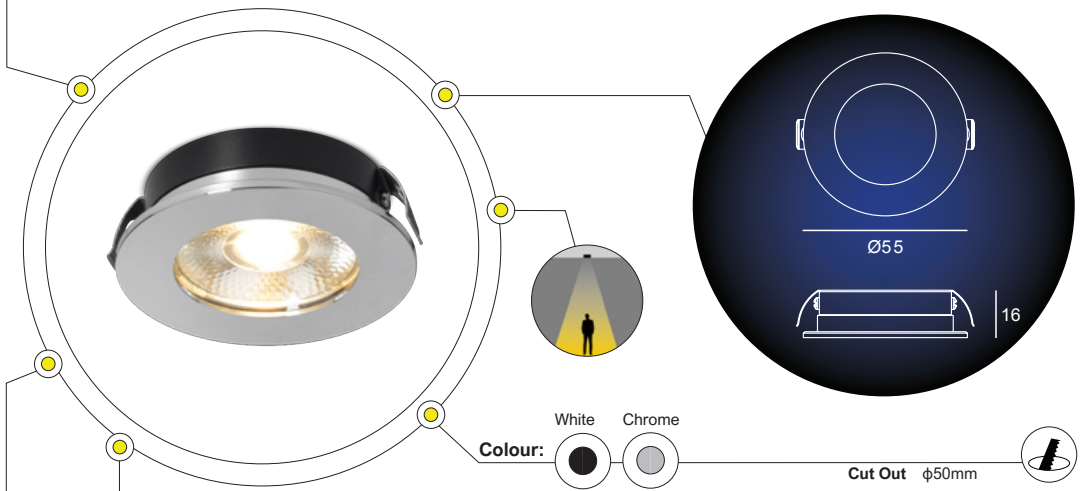

Cut Out ϕ 50mm

+ IP 54



LOA

5 YRS

ldt

PHYSICAL DATA

FEATURES

- Material: Aluminium
- The SLIM is an extremely thin miniature downlight allowing for easy installs in limited space and joinery
- The SLIM can also be installed in spaces that require water-resistant luminaires
- Driver: On/Off

- RGB DC version available

DRIVER DIMENSIONS

- L:40 x W:30 x H:30mm

MOUNTING: Recessed

APPLICATION AREAS

Indoor, Commercial, Residential, Retail, Hospitality

OPTIONS & ACCESSORIES

TECHNICAL DATA

LF199119EA

LAMP	LED
TOTAL POWER (W)	4.2W
SYSTEM OUTPUT (LM)	285LM
CCT (K)	3000 / 3500K
CRI (Ra)	90
BEAM ANGLE	22°
OPERATING VOLTAGE-VAC	100-240V
SOURCE POWER (W)	5.4W
SOURCE OUTPUT (LM)	426LM
CURRENT (MA)	200MA
FLICKER FACTOR	789.47 / 3.71%
UGR	15
MAC ADAM STEP	3SDCM
POWER FACTOR	0.95
DIMENSIONS	D: ϕ 55 x H:16mm
CUT OUT	D: ϕ 50mm



- CD / KLM
- C0 - C180
 - C90 - C270

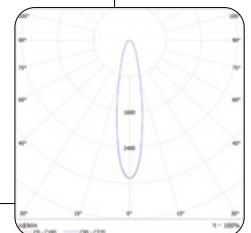

E&OE MAY OCCUR

➤ DOWNLIGHTS – RECESSED

GU10

DOWNLIGHTS – RECESSED – GU10



Project 189 on Main

LRD23GU1031

GU10 LED RECESSED DOWNLIGHT

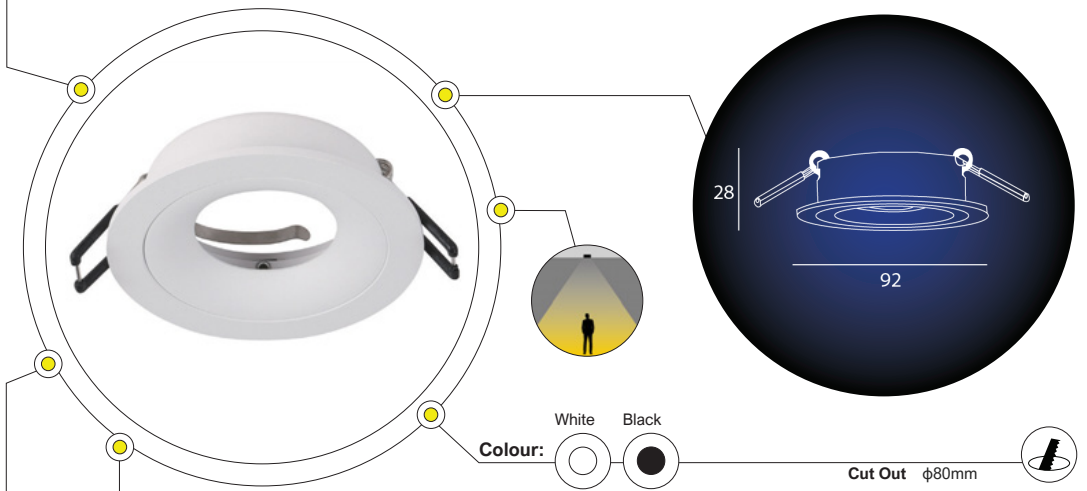

+ IP 20



LOA

2 YRS

PHYSICAL DATA

FEATURES

- Material: Aluminium
- Simple and elegant appearance
- Easy to install

MOUNTING

Recessed

APPLICATION AREAS

Indoor, Commercial, Residential, Retail, Hospitality

TECHNICAL DATA

LRD23GU1031

LAMP HOLDER	GU10
OPERATING VOLTAGE-VAC	230V 50Hz
DIMENSIONS	D:φ92 x H:28mm
CUT OUT	D:φ80mm
MINIMUM DEPTH (Suggested)	110mm

LAMP DATA

LPPAR165036

LAMP	LED
DIMMABLE	YES
BASE	GU10
TOTAL POWER (W)	5.5W
SYSTEM OUTPUT (LM)	380 / 400LM
CCT (K)	3000 / 4000 / 6500K
CRI (Ra)	90
BEAM ANGLE	36°
OPERATING VOLTAGE	220-240V
RATED LIFE (HRS)	25 000HRS
DIMENSIONS	D:φ51 x H:52mm



PLEASE NOTE

Lamp specifications and lamp warranties may differ

LRD23GU1031AD

GU10 LED RECESSED
DOWNLIGHT

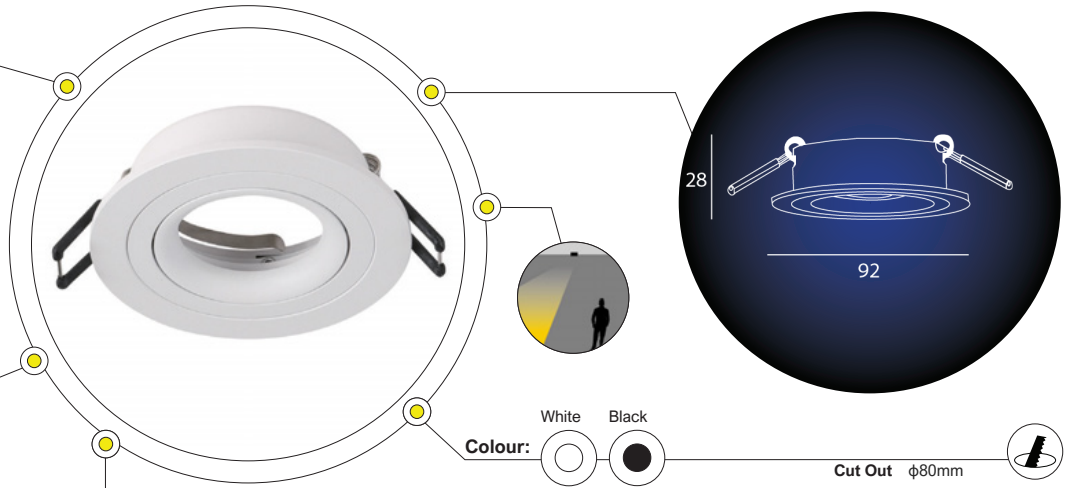

+ IP 20



LOA

2 YRS

PHYSICAL DATA

FEATURES

- Material: Aluminium
- Simple and elegant appearance
- Easy to install
- Adjustable

MOUNTING

Recessed

APPLICATION AREAS

Indoor, Commercial, Residential, Retail, Hospitality

TECHNICAL DATA

LRD23GU1031AD

LAMP HOLDER	GU10
VOLTAGE	230V 50Hz
DIMENSIONS	D:φ92 x H:28mm
CUT OUT	D:φ80mm
MINIMUM DEPTH (Suggested)	110mm

LAMP DATA

LPPAR165036

LAMP	LED
DIMMABLE	YES
BASE	GU10
TOTAL POWER (W)	5.5W
SYSTEM OUTPUT (LM)	380 / 400LM
CCT (K)	3000 / 4000 / 6500K
CRI (Ra)	90
BEAM ANGLE	36°
OPERATING VOLTAGE	220-240V
RATED LIFE (HRS)	25 000HRS
DIMENSIONS	D:φ51 x H:52mm



PLEASE NOTE

Lamp specifications and lamp warranties may differ

E&OE MAY OCCUR

LRD23GU1031IP

GU10 LED RECESSED
DOWNLIGHT

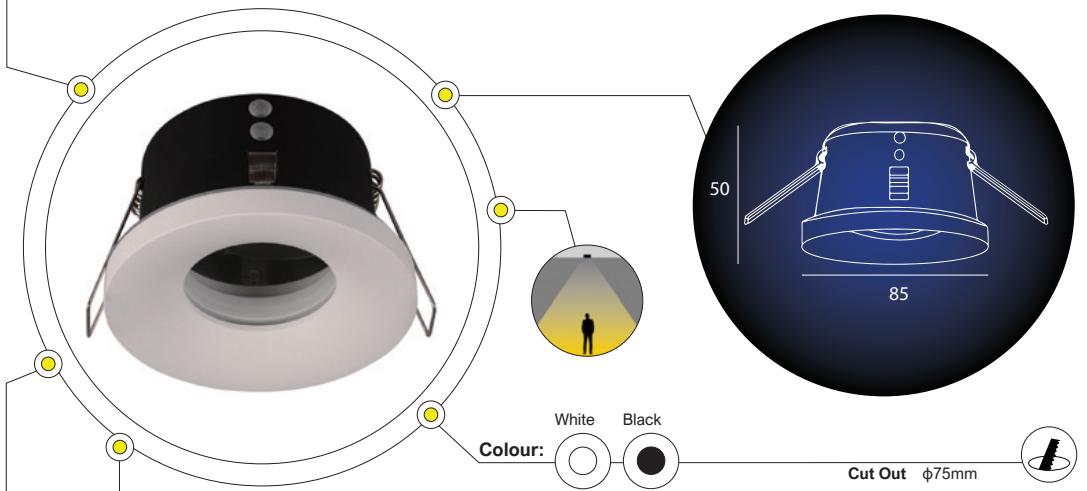

+ IP 65



LOA

2 YRS

PHYSICAL DATA

FEATURES

- Material: Aluminium
- Simple and elegant appearance
- Easy to install

MOUNTING

Recessed

APPLICATION AREAS

Indoor, Outdoor, Commercial, Residential, Retail, Hospitality

TECHNICAL DATA

LRD23GU1031IP

LAMP HOLDER	GU10
VOLTAGE	230V 50Hz
DIMENSIONS	D:φ85 x H:50mm
CUT OUT	D:φ75mm
MINIMUM DEPTH (Suggested)	130mm

LAMP DATA

LPPAR165036

LAMP	LED
DIMMABLE	YES
BASE	GU10
TOTAL POWER (W)	5.5W
SYSTEM OUTPUT (LM)	380 / 400LM
CCT (K)	3000 / 4000 / 6500K
CRI (Ra)	90
BEAM ANGLE	36°
OPERATING VOLTAGE	220-240V
RATED LIFE (HRS)	25 000HRS
DIMENSIONS	D:φ51 x H:52mm



PLEASE NOTE

Lamp specifications and lamp warranties may differ

LRD36

GU10 LED RECESSED
DOWNLIGHT

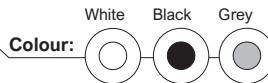
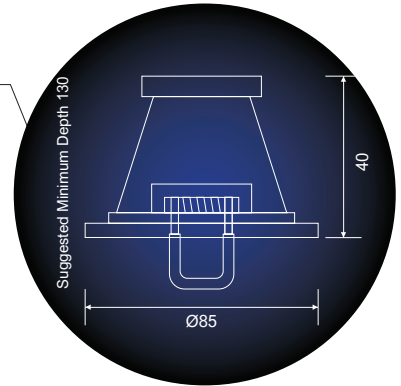

Cut Out ϕ 72mm



+ IP 20



LOA

3 YRS



PHYSICAL DATA

FEATURES

- Material: Aluminium
- Optional anti-glare accessories
- Simple lamp installation
- Adjustable - tilt

MOUNTING

Recessed

APPLICATION AREAS

Indoor, Commercial, Residential, Retail, Hospitality

TECHNICAL DATA

LRD36

LAMP HOLDER	GU10
VOLTAGE	230V 50Hz
DIMENSIONS	D: ϕ 85 x H:40mm
CUT OUT	D: ϕ 72mm

LAMP DATA

LPPAR165036

LAMP	LED
DIMMABLE	YES
BASE	GU10
TOTAL POWER (W)	5.5W
SYSTEM OUTPUT (LM)	380 / 400LM
CCT (K)	3000 / 4000 / 6500K
CRI (Ra)	90
BEAM ANGLE	36°
OPERATING VOLTAGE	220-240V
RATED LIFE (HRS)	25 000HRS
DIMENSIONS	D: ϕ 51 x H:52mm



PLEASE NOTE

Lamp specifications and lamp warranties may differ

E&OE MAY OCCUR

LRD52

GU10 LED RECESSED DOWNLIGHT

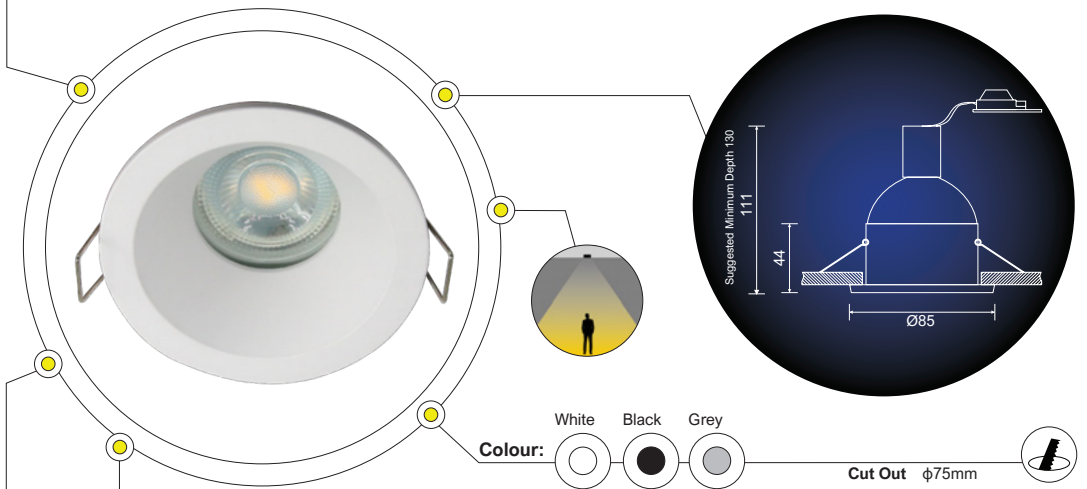

+ IP 65



LOA

3 YRS



PHYSICAL DATA

FEATURES

- Material: Aluminium
- Extruded aluminium housing with no external screws
- Electrostatic powder coating
- Simple lamp installation

MOUNTING

Recessed

APPLICATION AREAS

Indoor, Commercial, Residential, Retail, Hospitality

TECHNICAL DATA

LRD52

LAMP HOLDER	GU10
VOLTAGE	230V 50Hz
DIMENSIONS	D:φ85 x H:44mm
CUT OUT	D:φ75mm

LAMP DATA

LPPAR165036

LAMP	LED
DIMMABLE	YES
BASE	GU10
TOTAL POWER (W)	5.5W
SYSTEM OUTPUT (LM)	380 / 400LM
CCT (K)	3000 / 4000 / 6500K
CRI (Ra)	90
BEAM ANGLE	36°
OPERATING VOLTAGE	220-240V
RATED LIFE (HRS)	25 000HRS
DIMENSIONS	D:φ51 x H:52mm



PLEASE NOTE

Lamp specifications and lamp warranties may differ

➤ TRACK & TRACK SPOTS

1-CIRCUIT 3-WIRE TRACK

TRACK & TRACK SPOTS - 1-CIRCUIT 3-WIRE TRACK

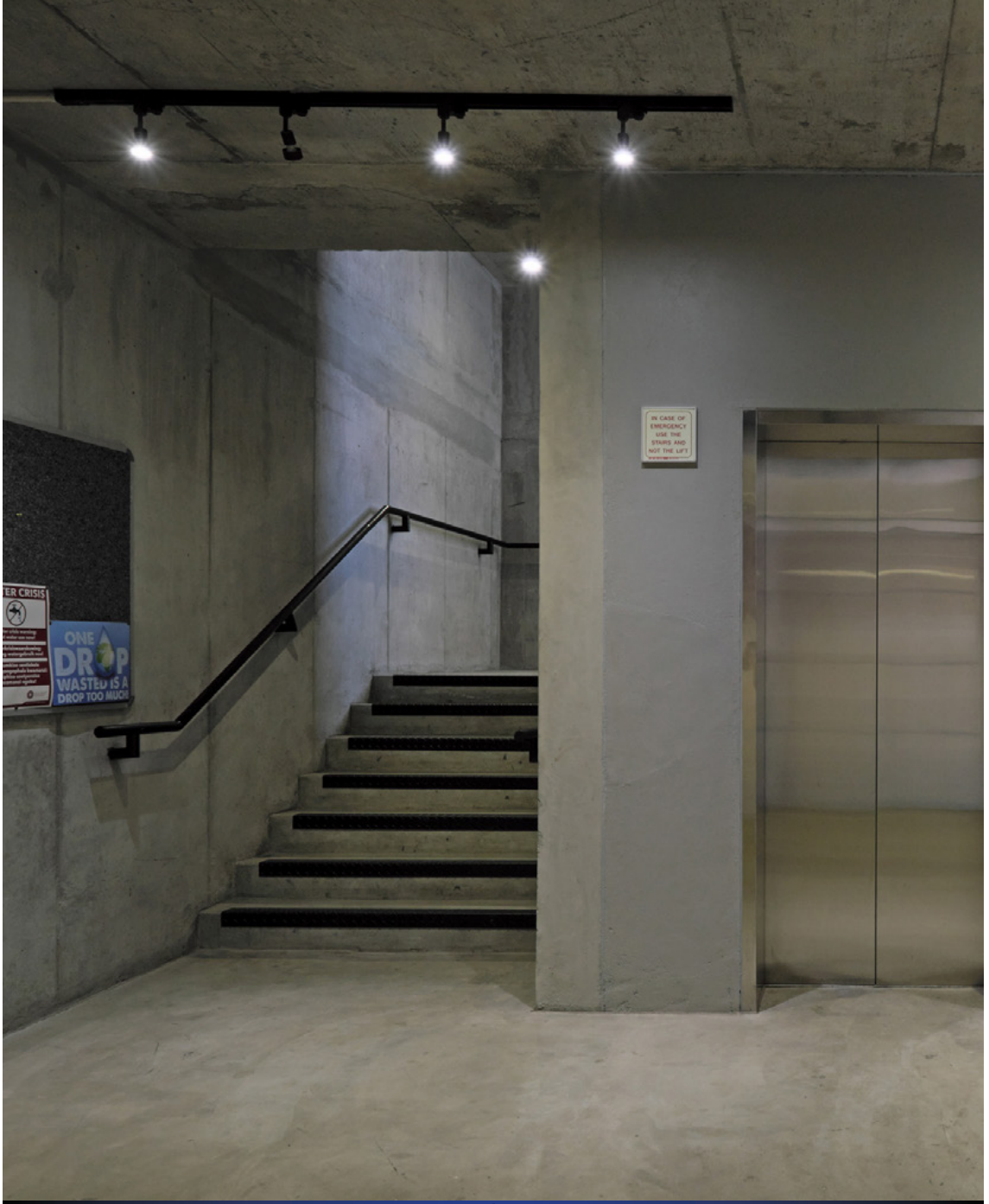

LBLT3

1-CIRCUIT 3-WIRE
SURFACE TRACK

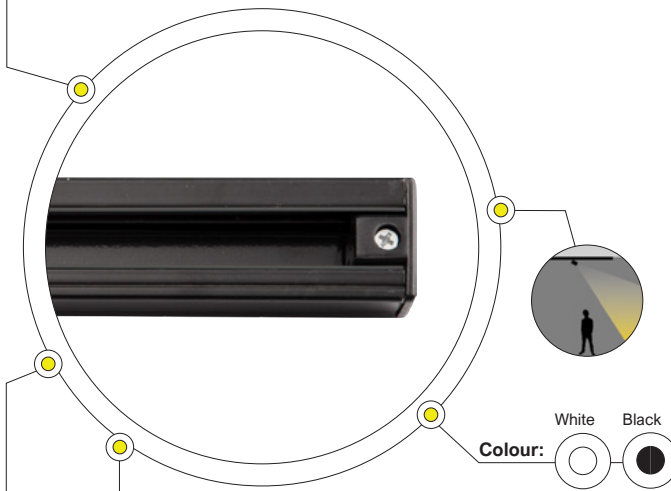

+ IP 20



3 YRS

PHYSICAL DATA

FEATURES

- 1-Circuit 3-Wire track

OPTIONS & ACCESSORIES

- Lengths for selection: 1m, 2m and 3m
- Complete with power feed and end-caps

MOUNTING

Surface

APPLICATION AREAS

Indoor, Commercial, Residential, Retail, Hospitality

TECHNICAL DATA

SURFACE TRACK			
PRODUCT CODE	LBLT3 30/31 1M	LBLT3 30/31 2M	LBLT3 30/31 3M
OPERATING VOLTAGE	220V	220V	220V
DIMENSIONS	1000 x 35 x 16mm	2000 x 35 x 16mm	3000 x 35 x 16mm



E&OE MAY OCCUR

LBLT3

ACCESSORIES

Standard Accessories



LBLT3PF
POWER FEED



LBLT3IJ
I-JOINER



LBLT3IC
I-CONNECTOR



LBLT3LC
L-CONNECTOR



LBLT3TC
T-CONNECTOR



LBLT3XC
X-CONNECTOR



LBLT3FC
FLEXI CONNECTOR



LBLT3TA
TRACK ADAPTER



LBLT3ST
SUSPENSION TRACK



LBLT3STK
SUSPENSION TRACK KIT

TRACK & TRACK SPOTS - 1CIRCUIT 3WIRE TRACK - LBLT3 ACCESSORIES

> 1-CIRCUIT 3-WIRE TRACK SPOTS

GU10



LTL23GU10

GU10 TRACK SPOT

TRACK & TRACK SPOTS - 1CIRCUIT 3WIRE TRACK SPOTS - LTL23GU10

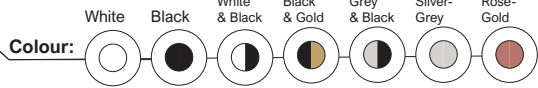
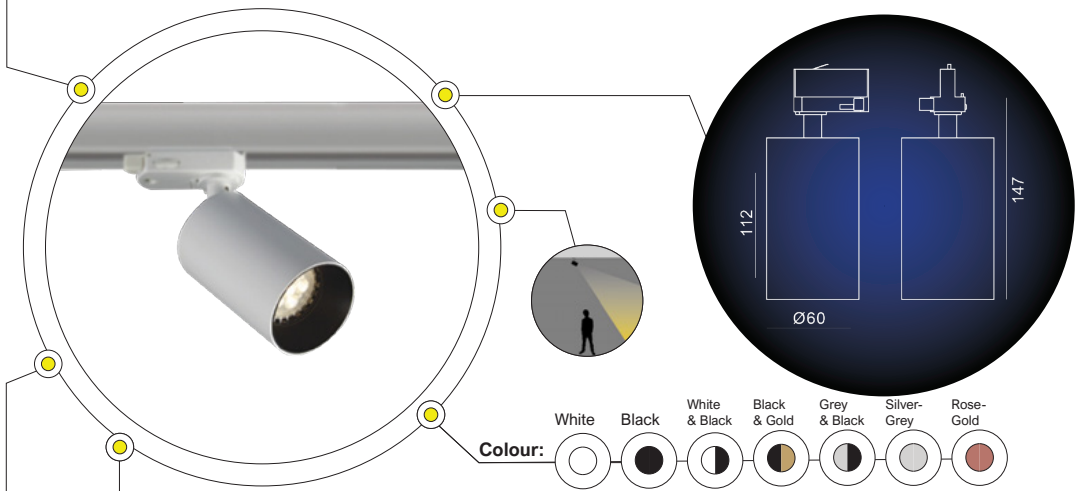

+IP 20



LOA

3 YRS



PHYSICAL DATA

FEATURES

- Material: Die-cast aluminium
- Track spot; adjustable with spot-head adjust of 90° tilt and 350° rotation

MOUNTING

Track

APPLICATION AREAS

Indoor, Commercial, Residential, Retail, Hospitality, Galleries

TECHNICAL DATA

LTL23GU10

LAMP HOLDER	GU10
TOTAL POWER (W)	7.5W max
OPERATING VOLTAGE-VAC	220-240V
DIMENSIONS	D:φ60 x H:112mm

LAMP DATA

LPPAR165036

LAMP	LED
DIMMABLE	YES
BASE	GU10
TOTAL POWER (W)	5.5W
SYSTEM OUTPUT (LM)	380 / 400LM
CCT (K)	3000 / 4000 / 6500K
CRI (Ra)	90
BEAM ANGLE	36°
OPERATING VOLTAGE	220-240V
RATED LIFE (HRS)	25 000HRS
DIMENSIONS	D:φ51 x H:52mm



PLEASE NOTE

Lamp specifications and lamp warranties may differ

E&OE MAY OCCUR

LTL24GU10

GU10 TRACK SPOT

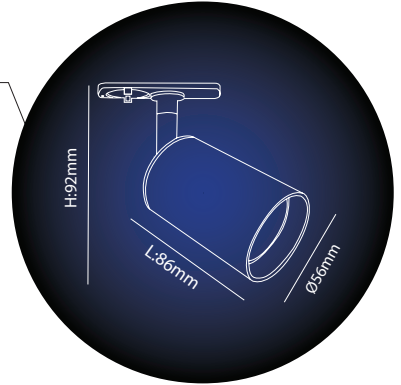
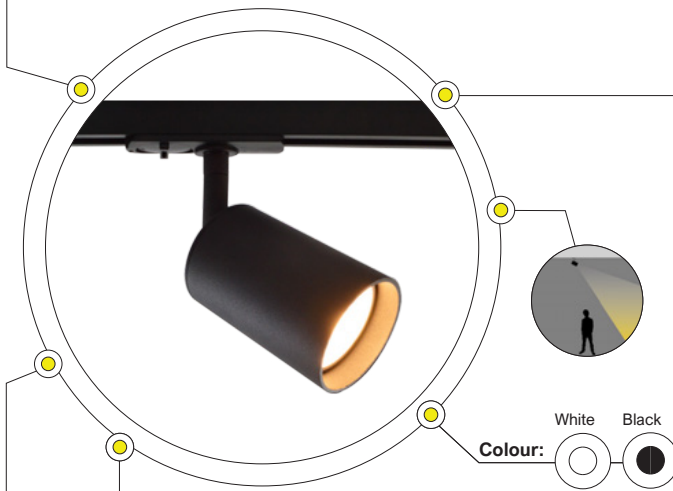

PHYSICAL DATA

FEATURES

- GU10 Spotlight for 3 Wire Track (Recessed Adaptor)
- Adjustable

MOUNTING

Track

APPLICATION AREAS

Indoor, Commercial, Residential, Retail, Hospitality

TECHNICAL DATA

LTL24GU10

LAMP HOLDER	GU10
TOTAL POWER (W)	50W
OPERATING VOLTAGE-VAC	230V 50Hz
DIMENSIONS	D:56 x H:92 x L:86mm

LAMP DATA

RECOMMENDATION

LAMP	LED
DIMMABLE	YES
BASE	GU10
TOTAL POWER (W)	5.5W
SYSTEM OUTPUT (LM)	380 / 400LM
CCT (K)	3000 / 4000 / 6500K
CRI (Ra)	90
BEAM ANGLE	36°
OPERATING VOLTAGE	220-240V
RATED LIFE (HRS)	25 000HRS
DIMENSIONS	D:φ51 x H:52mm



PLEASE NOTE

Lamp specifications and lamp warranties may differ

LTL25GU10

GU10 TRACK SPOT

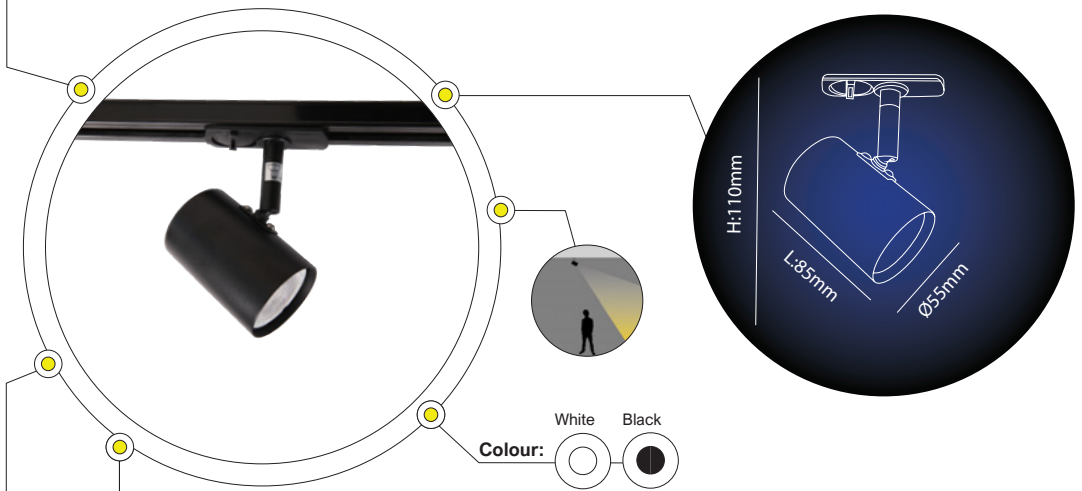

PHYSICAL DATA

FEATURES

- GU10 Spotlight for 3 Wire Track (Recessed Adaptor)
- Adjustable

MOUNTING

Track

APPLICATION AREAS

Indoor, Commercial, Residential, Retail, Hospitality



TECHNICAL DATA

LTL25GU10

LAMP HOLDER	GU10
TOTAL POWER (W)	50W
OPERATING VOLTAGE-VAC	230V 50Hz
DIMENSIONS	D:φ55 x H:110 x L:85mm

LAMP DATA

LPPAR165036

LAMP	LED
DIMMABLE	YES
BASE	GU10
TOTAL POWER (W)	5.5W
SYSTEM OUTPUT (LM)	380 / 400LM
CCT (K)	3000 / 4000 / 6500K
CRI (Ra)	90
BEAM ANGLE	36°
OPERATING VOLTAGE	220-240V
RATED LIFE (HRS)	25 000HRS
DIMENSIONS	D:φ51 x H:52mm



PLEASE NOTE

Lamp specifications and lamp warranties may differ

E&OE MAY OCCUR

LTL26GU10

GU10 TRACK SPOT

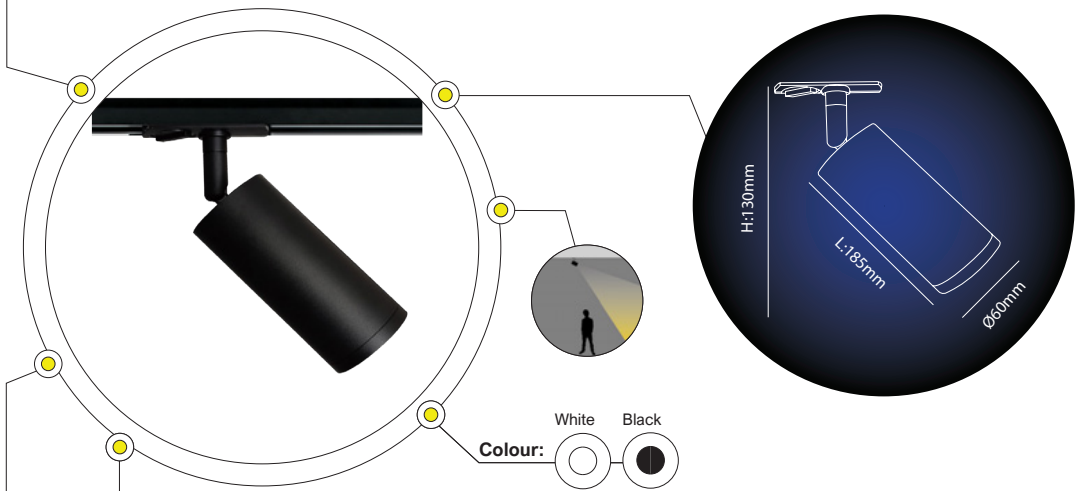

+ IP 20



✓ 1 YR



PHYSICAL DATA

FEATURES

- GU10 Long Spotlight for 3 Wire Track (Recessed Adaptor)
- Adjustable

MOUNTING

Track

APPLICATION AREAS

Indoor, Commercial, Residential, Retail, Hospitality

TECHNICAL DATA

LTL26GU10

LAMP HOLDER	GU10
TOTAL POWER (W)	35W
OPERATING VOLTAGE-VAC	230V 50Hz
DIMENSIONS	D:φ60 x H:130 x L:185mm

LAMP DATA

LPPAR165036

LAMP	LED
DIMMABLE	YES
BASE	GU10
TOTAL POWER (W)	5.5W
SYSTEM OUTPUT (LM)	380 / 400LM
CCT (K)	3000 / 4000 / 6500K
CRI (Ra)	90
BEAM ANGLE	36°
OPERATING VOLTAGE	220-240V
RATED LIFE (HRS)	25 000HRS
DIMENSIONS	D:φ51 x H:52mm



PLEASE NOTE

Lamp specifications and lamp warranties may differ

LTL29GU10

GU10 TRACK SPOT

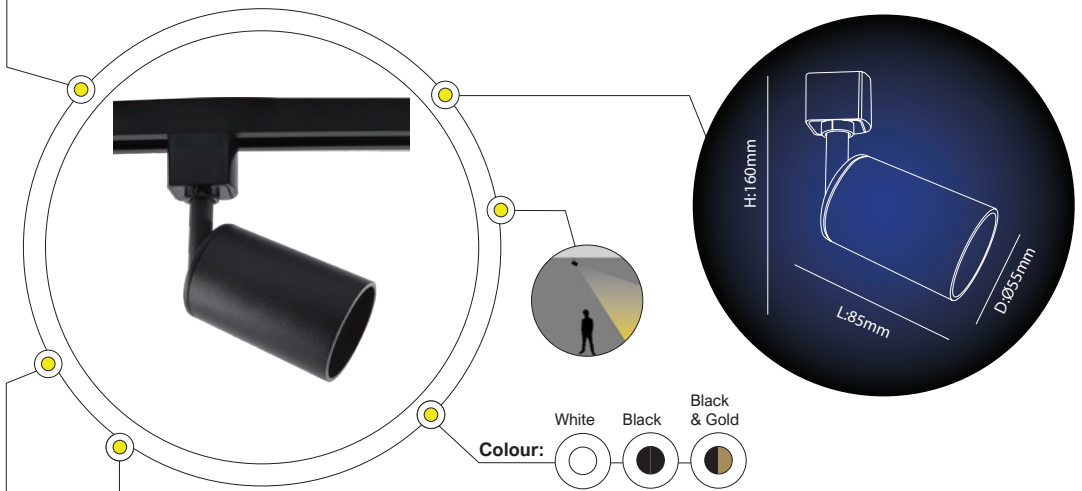

PHYSICAL DATA

FEATURES

- GU10 Anti-glare spotlight for 3 Wire Track (Recessed Adaptor)
- Adjustable

MOUNTING

Track

APPLICATION AREAS

Indoor, Commercial, Residential, Retail, Hospitality



TECHNICAL DATA

LTL29GU10

LAMP HOLDER	GU10
TOTAL POWER (W)	50W
OPERATING VOLTAGE-VAC	230V 50Hz
DIMENSIONS	D:φ55 x H:160 x L:85mm

LAMP DATA

LPPAR165036

LAMP	LED
DIMMABLE	YES
BASE	GU10
TOTAL POWER (W)	5.5W
SYSTEM OUTPUT (LM)	380 / 400LM
CCT (K)	3000 / 4000 / 6500K
CRI (Ra)	90
BEAM ANGLE	36°
OPERATING VOLTAGE	220-240V
RATED LIFE (HRS)	25 000HRS
DIMENSIONS	D:φ51 x H:52mm



PLEASE NOTE

Lamp specifications and lamp warranties may differ

E&OE MAY OCCUR

➤ 3-CIRCUIT TRACK

COMMERCIAL & ARCHITECTURAL



NLP 3 CIRCUIT - STANDARD

3-CIRCUIT SURFACE TRACK SYSTEM

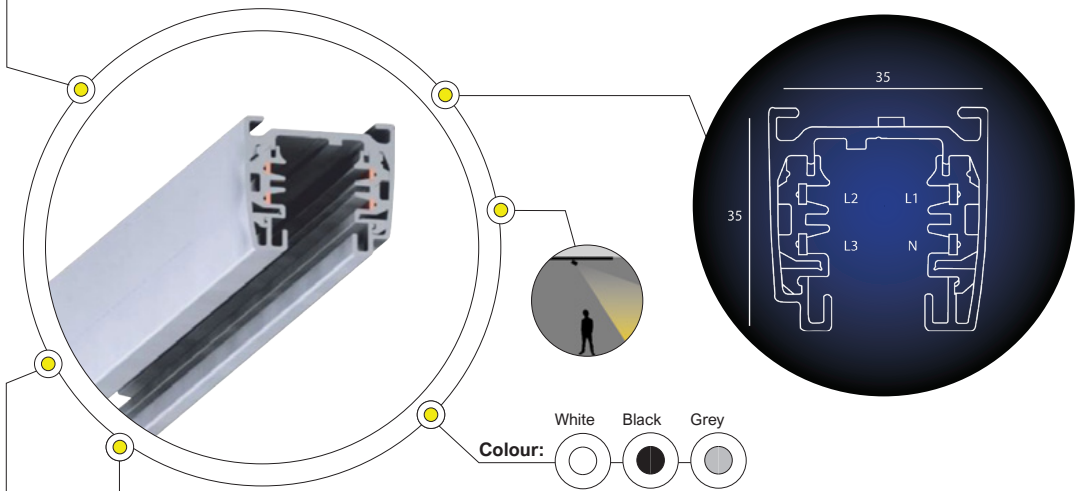

+ IP 20



LOA

3 YRS

PHYSICAL DATA

FEATURES

- NLP 3-Circuit Surface track system with thermoplastic connectors and metal accessories
- Tracks supplied with a paper covering
- Copper-leads nickle-plated for L2 maximum protection against oxidization of leads
- Knockout holes L3 in-track for direct to surface installation or via different ceiling brackets

OPTIONS & ACCESSORIES

- Lengths for selection: 1m, 2m, 3m and 4m
- The NLP 3-Circuit Recessed Track System is available for selection

MOUNTING: Surface Track

APPLICATION AREAS

Indoor, Commercial, Residential, Retail, Hospitality

TECHNICAL DATA

SURFACE TRACK				
PRODUCT CODE	N04728101	N04728102	N04728103	N04728104
OPERATING VOLTAGE	220V	220V	220V	220V
DIMENSIONS	1000 x 35 x 35mm	2000 x 35 x 35mm	3000 x 35 x 35mm	4000 x 35 x 35mm



Project: Tom Tailor

E&OE MAY OCCUR

TRACK & TRACK SPOTS - 3CIRCUIT TRACK - SURFACE

NLP 3 CIRCUIT - STANDARD

ACCESSORIES

Standard Accessories



N0471120
END COVER



N04720120
X-CONNECTOR



N04720220 / N04730220
T-CONNECTOR LEFT



N04720320 / N04730320
T-CONNECTOR - RIGHT



N04720420 / N04730420
L-CONNECTOR



N04720520
MIDDLE CONNECTOR



N04720620
END FEED LEFT



N04720720
END FEED RIGHT



N04720920
MINI CONNECTOR



N04725520
FLEXIBLE CONNECTOR



N04726420
FLEX 60 CONNECTOR



CM888
SURFACE ADAPTER

Suspension Parts



N04793
REINFORCEMENT PLATE



N04776
TRACK CLIP



N047181
R.P. WIRE SUSPENSION



N04718
TRACK CLIP WIRE/ROD

NLP 3 CIRCUIT - STANDARD

ACCESSORIES

TRACK & TRACK SPOTS - 3CIRCUIT TRACK - SURFACE - ACCESSORIES

Acoustic Ceilings



N047128
R.P. CEILING PROFILES



N047121
R.P. CEILING RECESSED



N04719
TRACK CLIP



N047100
TRACK CLIP RECESSED

Others



N047210
SUSPENSION HOOK



N017026
THREAD EXTENSION



N047286
SUSPENSION KIT

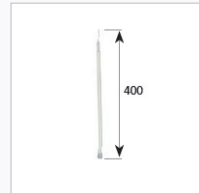

N047283
ROD SUSPENDED

Suspension Parts

Suspending a track can be done in two ways with wire or rod. Use 047-180 or 047-181 for this type of suspension

Wire: Thread the wire through the hole in the track clip and band it back up through the wire lock. Secure the wire with the screws

Rod: Thread the rod into the 047-181, the rod should have M6 threads. Screw: 047-76 or 047-93 can be used to fasten the track directly into the framework with a screw
To stabilize track on wire from tilting, use rod for wire suspension track system to fixate the track 047-283

Wire suspension type MaseTek to suspend fixed loads such as track systems



Acoustic Ceiling Parts

These parts are used for installing the track system into a acoustic ceiling.

There are two main types of acoustic ceilings, one with recessed profile (1) and one non recessed (2), choose mounting accessories according to ceiling type

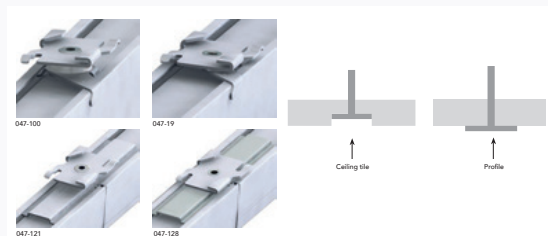

E&OE MAY OCCUR

NLP 3 CIRCUIT - RECESSED

3-CIRCUIT RECESSED TRACK SYSTEM

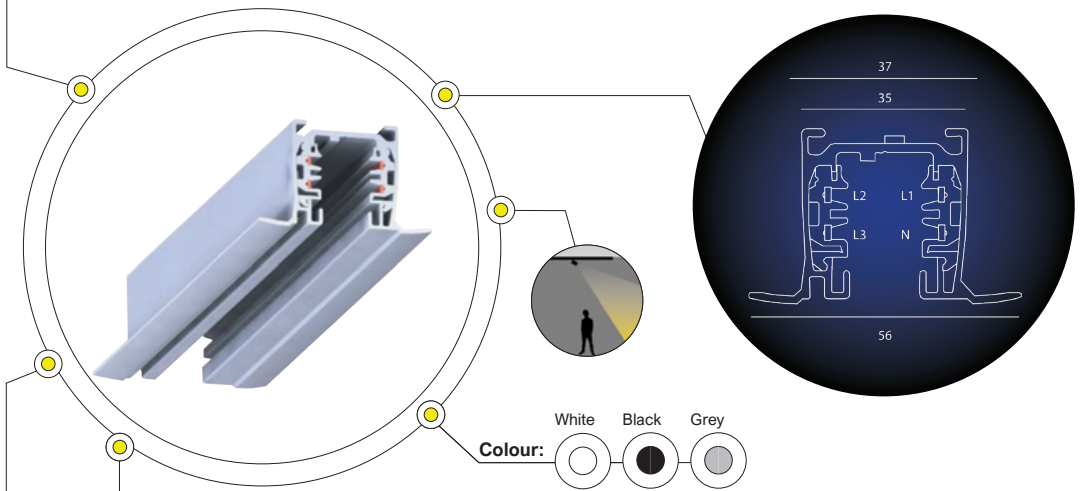

+ IP 20



LOA

3 YRS

PHYSICAL DATA

FEATURES

- NLP 3-Circuit Surface track system with thermoplastic connectors and metal accessories
- Tracks supplied with a paper covering
- Copper-leads nickle-plated for L2 maximum protection against oxidization of leads
- Knockout holes L3 in-track for direct to surface installation or via different ceiling brackets

OPTIONS & ACCESSORIES

- Lengths for selection: 1m, 2m, 3m and 4m
- The NLP 3-Circuit Surface Track System is available for selection

MOUNTING: Recessed Track

APPLICATION AREAS

Indoor, Commercial, Residential, Retail, Hospitality

TECHNICAL DATA

RECESSED TRACK

PRODUCT CODE	N04739	N04738	N04737	N04736
OPERATING VOLTAGE	220V	220V	220V	220V
DIMENSIONS	1000 x 56 x 37mm	2000 x 56 x 37mm	3000 x 56 x 37mm	4000 x 56 x 37mm



Project: H&M, V&A Waterfront

E&OE MAY OCCUR

NLP 3 CIRCUIT - RECESSED

ACCESSORIES

*Recessed
Accessories*



N0471120
END COVER



N047246
END FEED RIGHT



N047247 / N047347
L-CONNECTOR REV



N047248 / N047348
T-CONNECTOR LEFT



N047249 / N047349
T-CONNECTOR RIGHT



N047250
X-CONNECTOR



N047251
MIDDLE CONNECTOR



N047209
MINI CONNECTOR



N047245
END FEED LEFT

TRACK & TRACK SPOTS - 3CIRCUIT TRACK - RECESSED - ACCESSORIES

> 3-CIRCUIT TRACK SPOTS

COMMERCIAL



ExO I

TRACK LIGHT

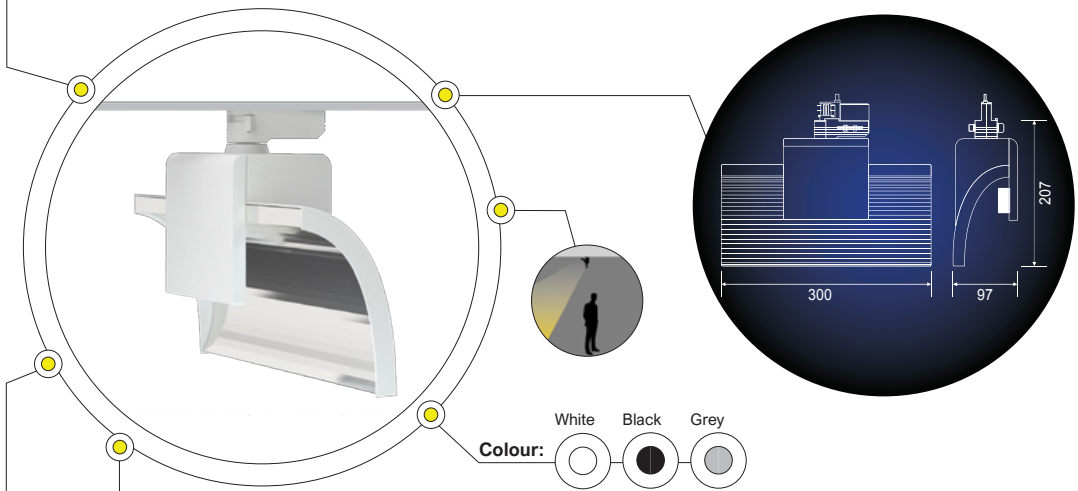

+ IP 20



LOA

5 YRS

ldt



PHYSICAL DATA

FEATURES

- Material: Die-cast aluminium
- Optics: Anodized aluminum reflector
- A powerful one-directional wall washer ideally suited for even and smooth wall washing in any retail environment
- All our ExO can be spaced far apart while still providing effective lighting. This results in lower initial installation and running costs
- Indirect lighting minimises glare and adjustable

OPTIONS & ACCESSORIES

- Other CCT (K) on request
- Double-sided option available
- Surface mount accessories optional

MOUNTING: Track

APPLICATION AREAS

Indoor, Commercial, Retail

TECHNICAL DATA

EXO I-3000-930

EXO I-3000-840

EXO I-4000-930

EXO I-4000-840

	EXO I-3000-930	EXO I-3000-840	EXO I-4000-930	EXO I-4000-840
LAMP	LED	LED	LED	LED
TOTAL POWER (W)	26W	22W	38W	30W
SYSTEM OUTPUT (LM)	2850LM	2950LM	3800LM	3850LM
EFFICACY (LM/W)	109	134	100	128
CCT (K)	3200K	4000K	3200K	4000K
CRI (Ra)	90	80	90	80
BEAM ANGLE	Wide Flood	Wide Flood	Wide Flood	Wide Flood
OPERATING VOLTAGE-VAC	220-240V	220-240V	220-240V	220-240V
RATED LIFE (HRS)	50 000 HRS	50 000 HRS	50 000 HRS	50 000 HRS
LUMEN MAINTENANCE	L70B50 @ 50 000HRS	L70B50 @ 50 000HRS	L70B50 @ 50 000HRS	L70B50 @ 50 000HRS
MAC ADAM STEP	3SDCM	3SDCM	3SDCM	3SDCM
WEIGHT (KG)	0.85KG	0.85KG	0.85KG	0.85KG
DIMENSIONS	L:300 x W:93 x H:207mm	L:300 x W:93 x H:207mm	L:300 x W:93 x H:207mm	L:300 x W:93 x H:207mm

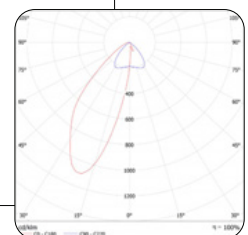

CD / KLM
C0 - C180
C90 - C270

E&OE MAY OCCUR

ExO II

TRACK LIGHT

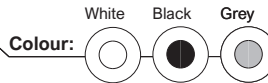
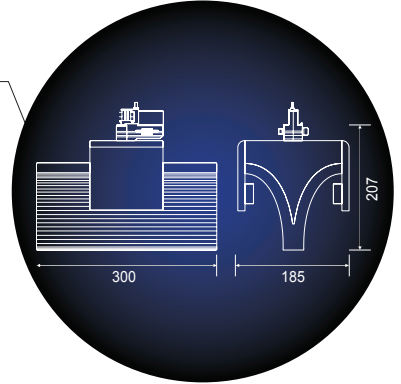
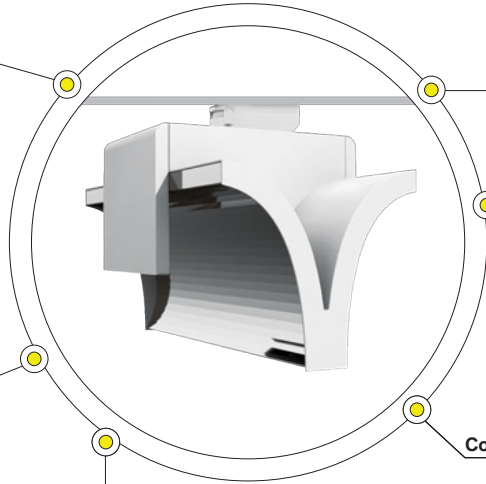

+ IP 20



LOA

5 YRS

ldt



PHYSICAL DATA

FEATURES

- Material: Die-cast aluminium
- Optics: anodized aluminum reflector
- A double-directional reflector, perfect for aisle lighting.
- Due to their high output and optimised optics the ExO series offers seamless, homogeneous lighting without bright or dark spots
- Indirect lighting also minimises glare
- Adjustable

OPTIONS & ACCESSORIES

- Other CCT (K) on request
- Single wall-washer option available
- Surface mount accessories optional

MOUNTING: Track

APPLICATION AREAS

Indoor, Commercial, Retail

TECHNICAL DATA

EXO II-3000-930

EXO II-3000-840

EXO II-4000-930

EXO II-4000-840

LAMP	LED	LED	LED	LED
TOTAL POWER (W)	2 x 26W	2 x 22W	2 x 38W	2 x 30W
SYSTEM OUTPUT (LM)	2 x 2850LM	2 x 2950LM	2 x 3800LM	2 x 3850LM
EFFICACY (LM/W)	109	134	100	128
CCT (K)	3200K	4000K	3200K	4000K
CRI (Ra)	>90	>80	>90	>80
BEAM ANGLE	Flood	Wide Flood	Wide Flood	Wide Flood
OPERATING VOLTAGE-VAC	220-240V	220-240V	220-240V	220-240V
RATED LIFE (HRS)	50 000 HRS	50 000 HRS	50 000 HRS	50 000 HRS
LUMEN MAINTENANCE	L70B50 @ 50 000HRS	L70B50 @ 50 000HRS	L70B50 @ 50 000HRS	L70B50 @ 50 000HRS
MAC ADAM STEP	3SDCM	3SDCM	3SDCM	3SDCM
WEIGHT (KG)	1.55KG	1.55KG	1.55KG	1.55KG
DIMENSIONS	L:300 x W:185 x H:207mm	L:300 x W:185 x H:207mm	L:300 x W:185 x H:207mm	L:300 x W:185 x H:207mm

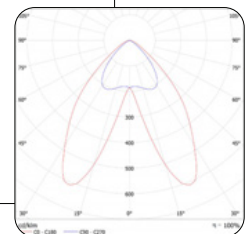

CD / KLM

● C0 - C180

● C90 - C270

E&OE MAY OCCUR

LTL21

TRACK LIGHT

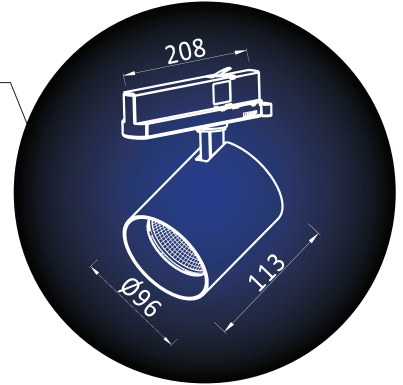
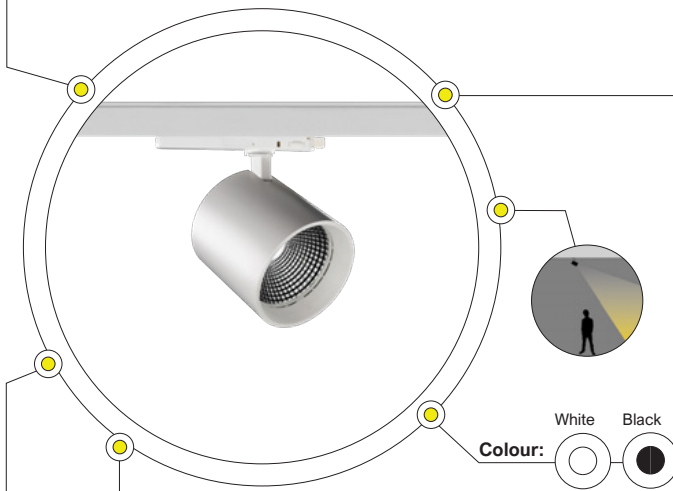

PHYSICAL DATA

FEATURES

- Material: Aluminium and polycarbonate housing
- Reflector with clear glass and safety wire
- Driver built into track adapter
- Better heat dissipation with higher density aluminium alloy. Adjustable
- Higher reflective efficiency with the ALANOD MIRO material. High-quality LEDs to ensure excellent chromatic yield for strict colour rendering

OPTIONS & ACCESSORIES

- Honeycomb, Barn Door, Glass accessories available

MOUNTING

Track

APPLICATION AREAS

Indoor, Commercial, Retail, Hospitality

+ IP 20



LOA

5 YRS

ldt



TECHNICAL DATA

LTL21

LAMP	LED
TOTAL POWER (W)	37W
SYSTEM OUTPUT	3443 / 3703LM (LM @ 3000K)
EFFICACY (LM/W)	90 / 99
CCT (K)	3000 / 3500 / 4000K
CRI (Ra)	>80
BEAM ANGLE	15° / 20° / 43° / 53°

OPERATING VOLTAGE-VAC	220-240V
RATED LIFE (HRS)	50 000 HRS
SOURCE POWER (W)	37W
SOURCE OUTPUT (LM)	4097 / 4325LM
CURRENT (MA)	900MA
ILLUM @ 1M (LUX)	14414/ 15662LX
FLICKER FACTOR	<4%
OPERATING TEMP °C	-20°C TO 50°C
POWER FACTOR	≥0.9
R9 VALUE	8
UGR	<18
MAC ADAM STEP	3SDCM
DIMENSIONS	208 x 113 x 96mm

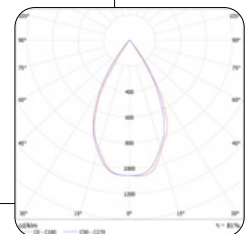

E&OE MAY OCCUR

REVOC MINI 2000

TRACK LIGHT

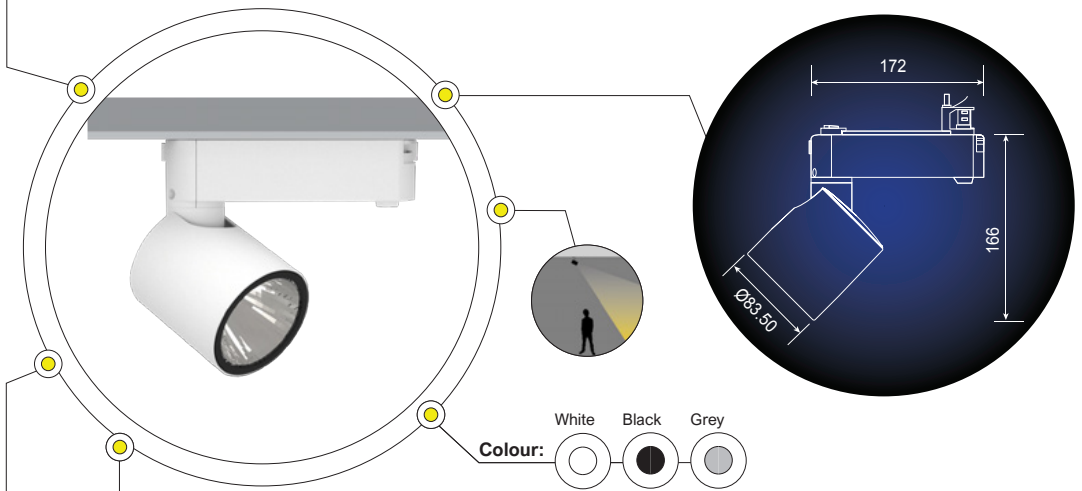

+ IP 20



LOA

5 YRS

ldt



PHYSICAL DATA

FEATURES

- Material: Die-cast aluminium
- Optics: Metalized aluminium reflector
- Track light with incorporated electronic gear and chip on board
- High quality reflectors with four different beam spreads
- Lamp housing of die-cast aluminium for optimal cooling, long lifetime and low weight
- Black front ring
- Adjustable with 90° tilt and 355° rotation capability

OPTIONS & ACCESSORIES

- Product available with food CCT and other Kelvin temperatures on request
- Accessories include Barn doors, Honeycomb filter, Filter holder and Asymmetric glass
- Surface mount and Hanger Bracket accessories optional

MOUNTING: Track

APPLICATION AREAS: Indoor, Commercial, Retail

TECHNICAL DATA

N28551

LAMP	LED
TOTAL POWER (W)	17W
SYSTEM OUTPUT (LM)	1890LM
EFFICACY (LM/W)	111
CCT (K)	3000 / 3500 / 4000K
CRI (Ra)	>90
BEAM ANGLE	16° / 28° / 47°
OPERATING VOLTAGE-VAC	220-240V
RATED LIFE (HRS)	50 000HRS
LUMEN MAINTENANCE	L70B50 @ 50 000HRS
MAC ADAM STEP	3SDCM
WEIGHT (KG)	0.76KG
DIMENSIONS	D:φ83.5 x W:172 x H:166mm

NOTE - Please specify required beam angle when ordering

Spot		Medium		Flood	
	16°		28°		40°
m	Ø	m	Ø	m	Ø
1.0	0.28	1.0	0.50	1.0	0.73
2.0	0.56	2.0	1.00	2.0	1.46
3.0	0.83	3.0	1.51	3.0	2.18

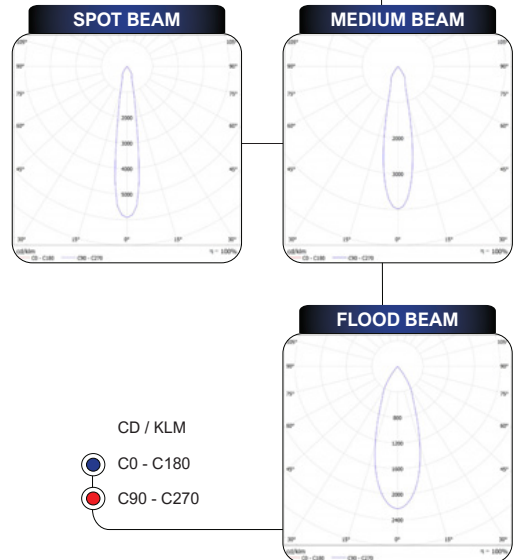

E&OE MAY OCCUR

REVOC 4000

TRACK LIGHT

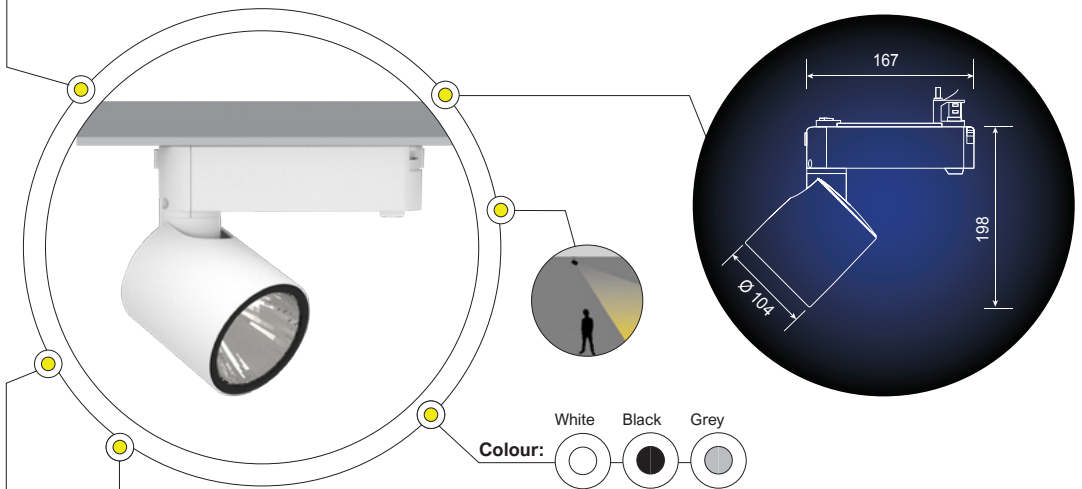

+ IP 20



LOA

5 YRS

ldt



PHYSICAL DATA

FEATURES

- Material: Die-cast aluminium
- Optics: Metalized aluminium reflector
- Track light with incorporated electronic gear and chip on board
- High quality reflectors with four different beam spreads
- Lamp housing of die-cast aluminium for optimal cooling, long lifetime and low weight
- Black front ring
- Adjustable with 90° tilt and 355° rotation capability

OPTIONS & ACCESSORIES

- Product available with food CCT and other Kelvin temperatures on request
- Accessories include Barn doors, Honeycomb filter, Filter holder and Asymmetric glass
- Surface mount and Hanger Bracket accessories optional

MOUNTING: Track

APPLICATION AREAS: Indoor, Commercial, Retail

TECHNICAL DATA

N28751

LAMP	LED
TOTAL POWER (W)	36W
SYSTEM OUTPUT (LM)	3800LM
EFFICACY (LM/W)	105
CCT (K)	3000 / 3500 / 4000K
CRI (Ra)	>90
BEAM ANGLE	14° / 27° / 38° / 56°
OPERATING VOLTAGE-VAC	220-240V
RATED LIFE (HRS)	50 000HRS
LUMEN MAINTENANCE	L70B50 @ 50 000HRS
MAC ADAM STEP	3SDCM
WEIGHT (KG)	1KG
DIMENSIONS	D:φ104 x W:167 x H:198mm

NOTE - Please specify required beam angle when ordering

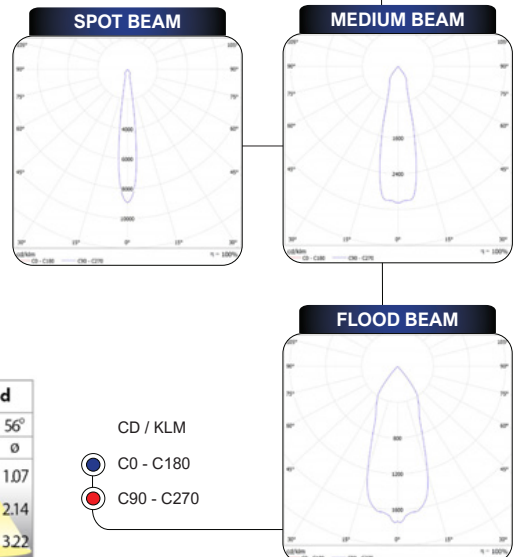

Spot		Medium		Flood		Wide Flood	
14°		27°		38°		56°	
m	φ	m	φ	m	φ	m	φ
1.0	0.25	1.0	0.48	1.0	0.69	1.0	1.07
2.0	0.49	2.0	0.95	2.0	1.39	2.0	2.14
3.0	0.74	3.0	1.43	3.0	2.08	3.0	3.22

TUBIX MINI 2000

TRACK LIGHT

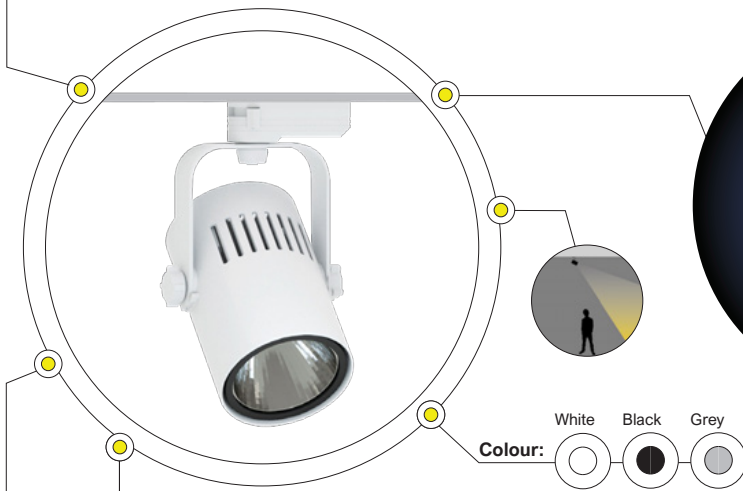

+ IP 20



LOA

5 YRS

ldt



PHYSICAL DATA

FEATURES

- Material: Die-cast aluminium
- Metalized aluminium reflector
- Track light with incorporated electronic gear and chip on board
- High quality reflectors with four different beam spreads
- Lamp housing of die-cast aluminium for optimal cooling, long lifetime and low weight
- Black front ring
- Adjustable with 90° tilt and 355° rotation capability

OPTIONS & ACCESSORIES

- Product available in other Kelvin temperatures on request
- Accessories include Anti-dazzle snoot, Barn doors, Honeycomb filter, Diffuser glass and Asymmetric glass
- Surface mount and Hanger Bracket accessories optional

MOUNTING: Track

APPLICATION AREAS: Indoor, Commercial, Retail

TECHNICAL DATA

N29151

LAMP	LED
TOTAL POWER (W)	17W
SYSTEM OUTPUT (LM)	1890LM
EFFICACY (LM/W)	111
CCT (K)	3200 / 4200K
CRI (Ra)	>90
BEAM ANGLE	16° / 28° / 40° / 65°
OPERATING VOLTAGE-VAC	220-240V
RATED LIFE (HRS)	50 000HRS
LUMEN MAINTENANCE	L70B50 @ 50000HRS
WEIGHT (KG)	0.76KG
DIMENSIONS	D:φ87 x W:115 x H:308mm

NOTE - Please specify required beam angle when ordering

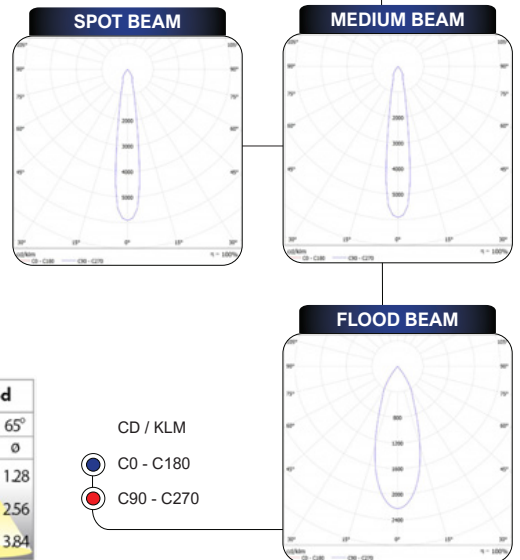

Spot		Medium		Flood		Wide Flood	
16°		28°		40°		65°	
m	ø	m	ø	m	ø	m	ø
1.0	0.28	1.0	0.50	1.0	0.73	1.0	1.28
2.0	0.56	2.0	1.00	2.0	1.46	2.0	2.56
3.0	0.83	3.0	1.51	3.0	2.18	3.0	3.84

E&OE MAY OCCUR

TUBIX 3000/4000

TRACK LIGHT

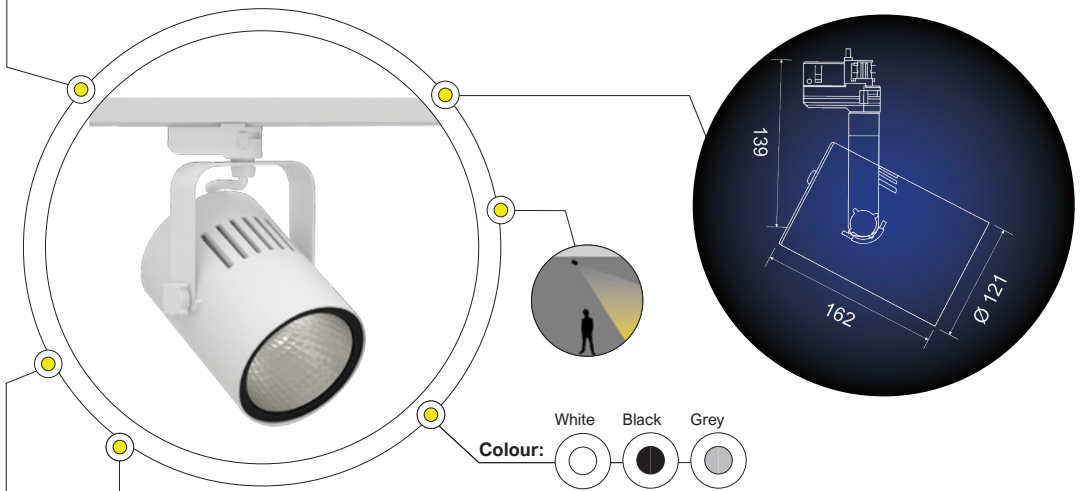

+ IP 20



LOA

5 YRS

ldt



PHYSICAL DATA

FEATURES

- Material: Die-cast aluminium
- Metalized aluminium reflector
- Track light with incorporated electronic gear and chip on board
- High quality reflectors with four different beam spreads
- Lamp housing of die-cast aluminium for optimal cooling, long lifetime and low weight
- Black front ring
- Adjustable with 90° tilt and 355° rotation capability

OPTIONS & ACCESSORIES

- Product available with food CCT and other Kelvin temperatures on request
- Accessories include Barn doors, Honeycomb filter, Diffuser glass and Asymmetric glass
- Surface mount and Hanger Bracket accessories optional

MOUNTING: Track

APPLICATION AREAS: Indoor, Commercial, Retail

TECHNICAL DATA

N27450

LAMP	LED
TOTAL POWER (W)	24 / 35W
SYSTEM OUTPUT (LM)	2800 / 3800LM
EFFICACY (LM/W)	116 / 108
CCT (K)	3000 / 4000K
CRI (Ra)	>90
BEAM ANGLE	14° / 26° / 37° / 55°
OPERATING VOLTAGE-VAC	220-240V
RATED LIFE (HRS)	50 000HRS
LUMEN MAINTENANCE	L70B50 @ 50000HRS
MAC ADAM STEP	3 SDCM
WEIGHT (KG)	1.2KG
DIMENSIONS	D:φ121 x L:162 x H:139mm

NOTE - Please specify required beam angle when ordering

SPOT BEAM

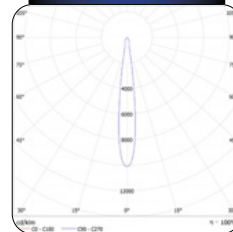

MEDIUM BEAM

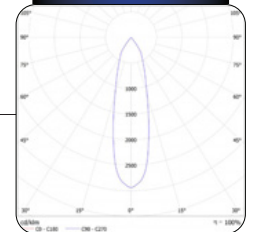

FLOOD BEAM

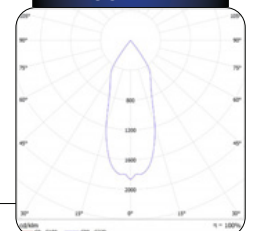

Spot		Medium		Flood		Wide Flood	
14°		26°		37°		55°	
m	φ	m	φ	m	φ	m	φ
1.0	0.24	1.0	0.47	1.0	0.68	1.0	1.05
2.0	0.48	2.0	0.94	2.0	1.35	2.0	2.10
3.0	0.72	3.0	1.41	3.0	2.03	3.0	3.15

CD / KLM

● C0 - C180

● C90 - C270

E&OE MAY OCCUR

ULTRA MINI 1500

TRACK LIGHT

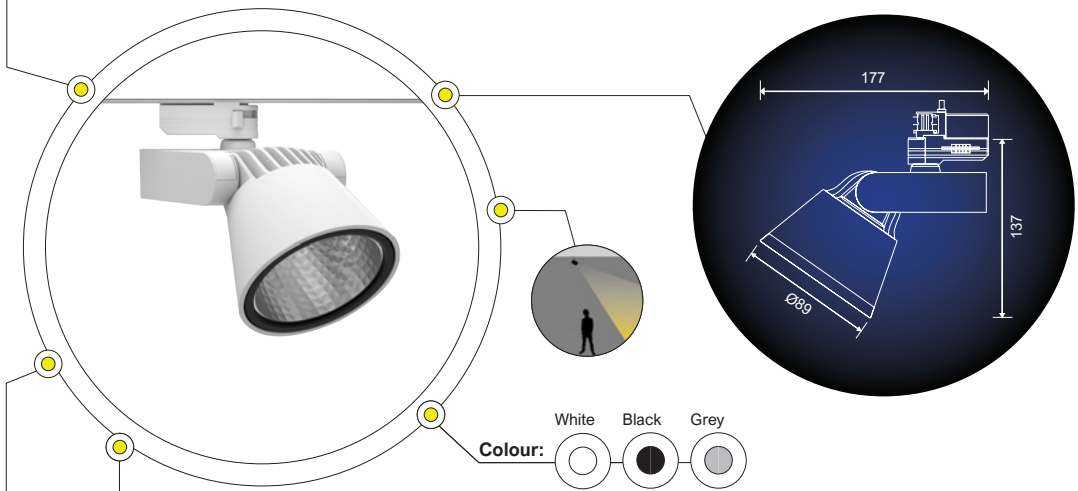

+ IP 20



LOA

5 YRS

ldt



PHYSICAL DATA

FEATURES

- Material: Die-cast aluminium
- Metalized aluminium reflector
- Track light with incorporated electronic gear and chip on board
- High quality reflectors with three different beam spreads
- Lamp housing of die-cast aluminium for optimal cooling, long lifetime and low weight
- Adjustable with 90° tilt and 355° rotation capability

OPTIONS & ACCESSORIES

- Product available in other Kelvin temperatures on request
- Accessories include Diffuser glass and Asymmetric glass
- Surface mount and Hanger Bracket accessories optional

MOUNTING: Track

APPLICATION AREAS: Indoor, Commercial, Retail

TECHNICAL DATA

N27750

LAMP	LED
TOTAL POWER (W)	12W
SYSTEM OUTPUT (LM)	1380LM
EFFICACY (LM/W)	115
CCT (K)	3000 / 4000K
CRI (Ra)	>90
BEAM ANGLE	16° / 28° / 40°
OPERATING VOLTAGE-VAC	220-240V
RATED LIFE (HRS)	50 000HRS
LUMEN MAINTENANCE	L70B50@50000HRS
MAC ADAM STEP	3SDCM
WEIGHT (KG)	0.76KG
DIMENSIONS	D:Ø89 x W:177 x H:137mm

NOTE - Please specify required beam angle when ordering

Spot		Medium		Flood	
	16°		28°		40°
m	Ø	m	Ø	m	Ø
1.0	0.28	1.0	0.50	1.0	0.73
2.0	0.56	2.0	1.00	2.0	1.46
3.0	0.83	3.0	1.51	3.0	2.18

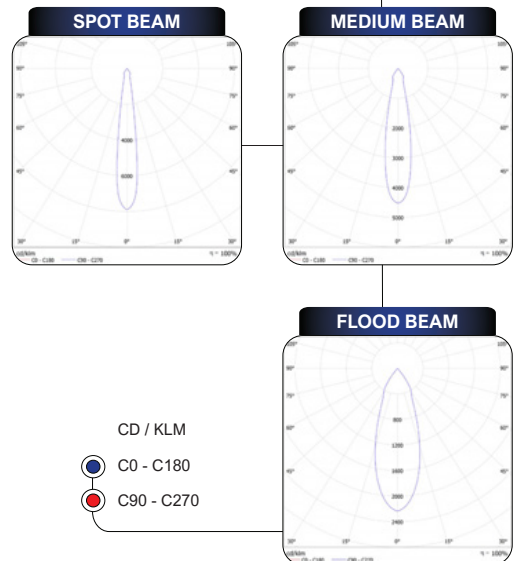

E&OE MAY OCCUR

ULTRA 3000

TRACK LIGHT

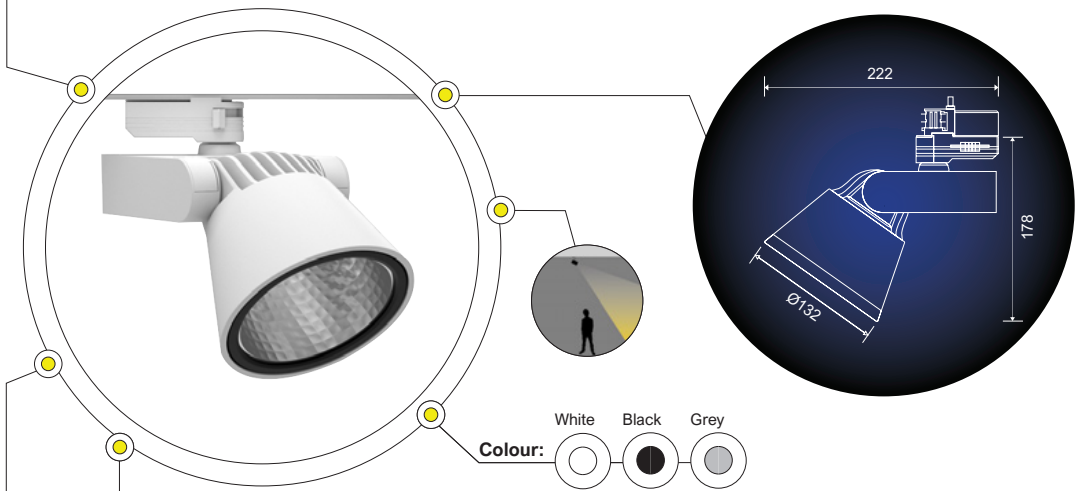

+ IP 20



LOA

5 YRS

ldt



PHYSICAL DATA

FEATURES

- Material: Die-cast aluminium
- Metalized aluminium reflector
- Track light with incorporated electronic gear and chip on board
- High quality reflectors with four different beam spreads
- Lamp housing of die-cast aluminium for optimal cooling, long lifetime and low weight
- Black front ring
- Adjustable with 90° tilt and 355° rotation capability

OPTIONS & ACCESSORIES

- Product available in other Kelvin temperatures on request
- Accessories include Diffuser glass and Asymmetric glass
- Surface mount and Hanger Bracket accessories optional

MOUNTING: Track

APPLICATION AREAS: Indoor, Commercial, Retail

TECHNICAL DATA

N26550

LAMP	LED
TOTAL POWER (W)	24.5W
SYSTEM OUTPUT (LM)	2800LM
EFFICACY (LM/W)	114
CCT (K)	3000 / 4000K
CRI (Ra)	>90
BEAM ANGLE	14° / 26° / 37° / 55°
OPERATING VOLTAGE-VAC	220-240V
RATED LIFE (HRS)	50 000HRS
LUMEN MAINTENANCE	L70B50 @ 50000HRS
MAC ADAM STEP	3SDCM
WEIGHT (KG)	1KG
DIMENSIONS	D:φ132 x W:222 x H:178mm

NOTE - Please specify required beam angle when ordering

SPOT BEAM

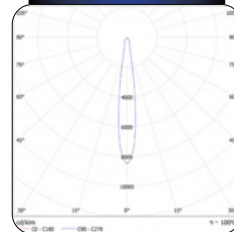

MEDIUM BEAM

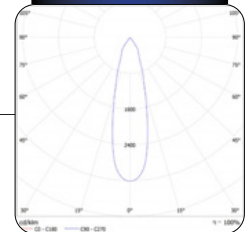

FLOOD BEAM

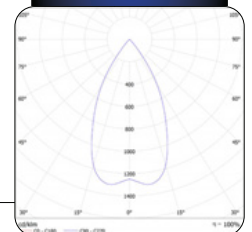

Spot		Medium		Flood		Wide Flood	
14°		26°		37°		55°	
m	φ	m	φ	m	φ	m	φ
1.0	0.24	1.0	0.47	1.0	0.68	1.0	1.05
2.0	0.48	2.0	0.94	2.0	1.35	2.0	2.10
3.0	0.72	3.0	1.41	3.0	2.03	3.0	3.15

CD / KLM

● C0 - C180

● C90 - C270

E&OE MAY OCCUR

ZEN EVO 4000/5000

TRACK LIGHT

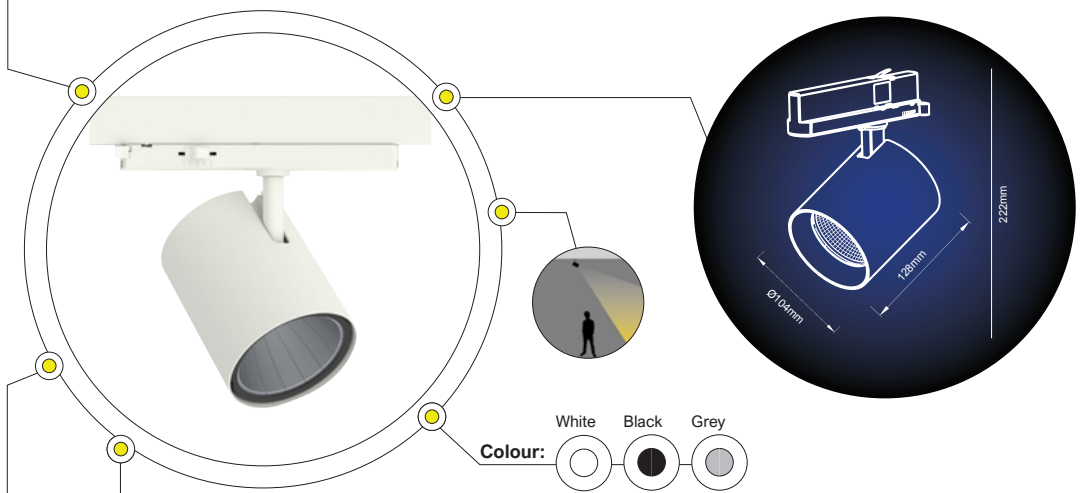

+ IP 20



LOA

5 YRS

ldt



PHYSICAL DATA

FEATURES

- Material: Die-cast aluminium
- Very minimalistic/clean design
- High lumen output, perfect for the grocery and DIY retail sectors
- Highly efficient chip on board LED light source and segmented reflector for maximum efficacy
- Integrated, highly efficient electronic control gear in the track adapter
- Very slim design with only the spot head visible below the track itself

- Adjustable with 90° tilt and 355° rotation capability

OPTIONS & ACCESSORIES

- Product available in other Kelvin temperatures on request
- Optional accessories include cover glass available on request

MOUNTING: Track

APPLICATION AREAS: Indoor, Commercial, Retail

TECHNICAL DATA

N369

LAMP	LED
TOTAL POWER (W)	31.6 / 40.7W
SYSTEM OUTPUT (LM)	4000 / 4800LM
EFFICACY (LM/W)	126 / 118
CCT (K)	3000K
CRI (Ra)	>90
BEAM ANGLE	16° / 29° / 40° / 60°
OPERATING VOLTAGE-VAC	220-240V
RATED LIFE (HRS)	50 000HRS
LUMEN MAINTENANCE	L80B10 @ 50000HRS
WEIGHT (KG)	0.49KG
DIMENSIONS	D:φ104 x H:222mm

NOTE - Please specify required beam angle when ordering

Spot		Medium		Flood		Wide Flood	
16°		29°		40°		60°	
m	Ø	m	Ø	m	Ø	m	Ø
1.0	0.31	1.0	0.52	1.0	0.76	1.0	1.16
2.0	0.62	2.0	1.05	2.0	1.52	2.0	2.32
3.0	0.93	3.0	1.57	3.0	2.28	3.0	3.48

E&OE MAY OCCUR

ZEN MINI 3000

TRACK LIGHT

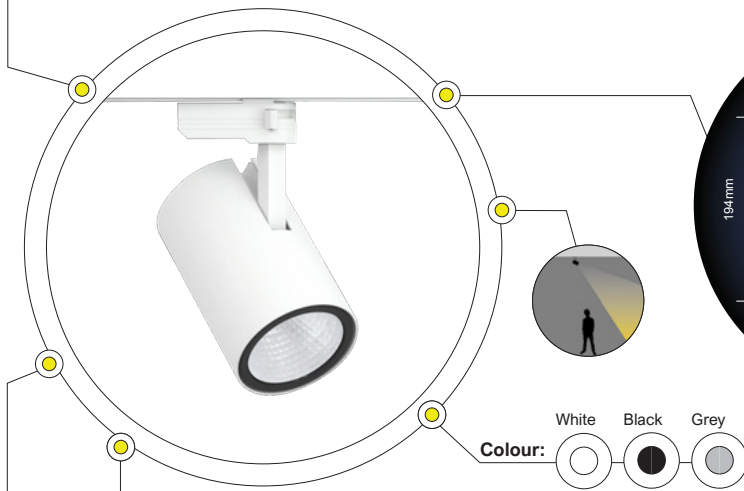

+ IP 20



LOA

5 YRS

ldt



PHYSICAL DATA

FEATURES

- Material: Die-cast aluminium
- Metalized aluminium reflector
- Track light with incorporated electronic gear and chip on board
- High quality reflectors with three different beam spreads
- Lamp housing of die-cast aluminium for optimal cooling, long lifetime and low weight
- Adjustable with 90° tilt and 355° rotation capability

OPTIONS & ACCESSORIES

- Product available in other Kelvin temperatures on request
- Accessories include Anti-dazzle snoot, Barn doors, Honeycomb filter, Filter holder and Asymmetric Glass
- Surface mount and Hanger Bracket accessories optional

MOUNTING: Track

APPLICATION AREAS: Indoor, Commercial, Retail

TECHNICAL DATA

N32550

LAMP	LED
TOTAL POWER (W)	24W
SYSTEM OUTPUT (LM)	2800LM
EFFICACY (LM/W)	114
CCT (K)	3000 / 4000K
CRI (Ra)	>90
BEAM ANGLE	18° / 31° / 42°
OPERATING VOLTAGE-VAC	220-240V
RATED LIFE (HRS)	50 000HRS
LUMEN MAINTENANCE	L70B50@50000HRS
MAC ADAM STEP	3SDCM
WEIGHT (KG)	0.65KG
DIMENSIONS	D:φ86 x W:135 x H:194mm

NOTE - Please specify required beam angle when ordering

Spot		Medium		Flood	
m	Ø	m	Ø	m	Ø
1.0	0.31	1.0	0.52	1.0	0.76
2.0	0.62	2.0	1.05	2.0	1.52
3.0	0.93	3.0	1.57	3.0	2.28

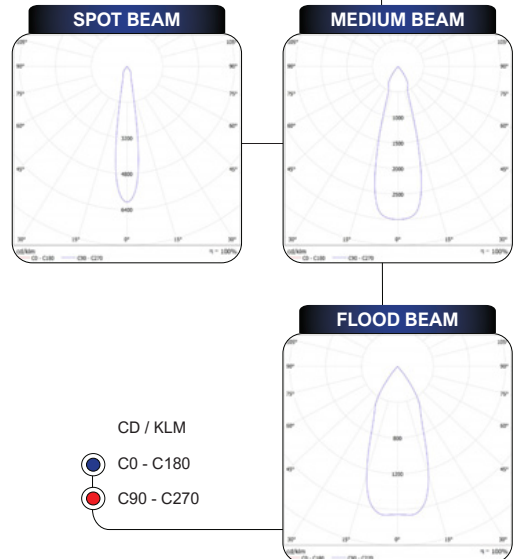

E&OE MAY OCCUR

> 3-CIRCUIT TRACK SPOTS

ARCHITECTURAL



DOMO T

TRACK LIGHT

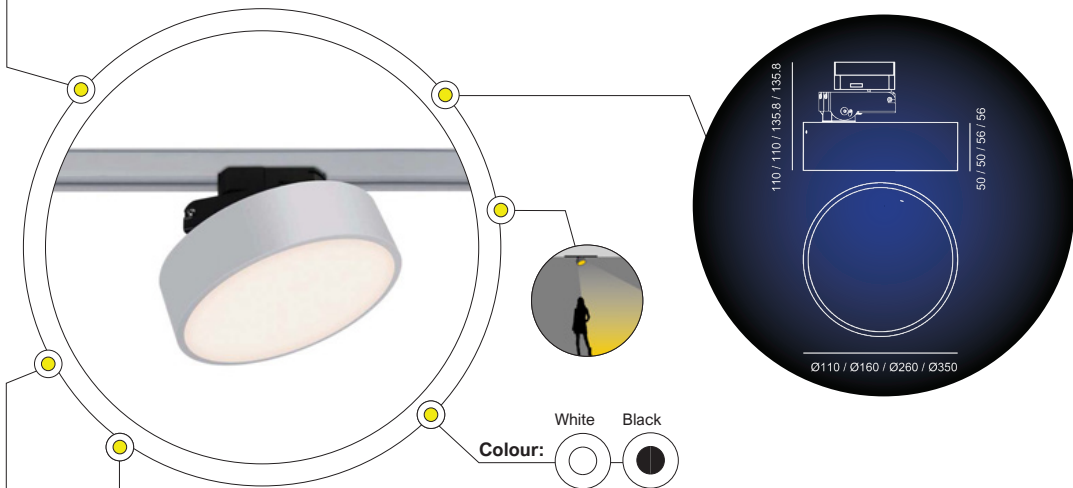

+ IP 20



LOA

3 YRS

ldt



PHYSICAL DATA

FEATURES

- Material: Aluminium
- The DOMO T is an adjustable track floodlight especially made for the traditional two-wire, three-wire and four-wire adaptor track systems

- The DOMO range includes recessed, adjustable recessed, surface ceiling lights, up/down light-beam surface ceiling lights, surface spot lights and track lights for the LUNA M and LUCA S track systems

OPTIONS & ACCESSORIES

- TRIAC dimming versions available on request
- The DOMO T is available in the following diameters: 110mm, 160mm, 260mm and 350mm

MOUNTING: Track

APPLICATION AREAS:

Indoor, Commercial, Retail, Hospitality

TECHNICAL DATA

	LF510114A	LF510214DT	LF513414A	LF513414A
LAMP	LED	LED	LED	LED
DRIVER	ON/OFF	TRIAC DIM	ON/OFF	ON/OFF
TOTAL POWER (W)	4.8W	9.6W	15.7W	20.1W
SYSTEM OUTPUT (LM)	307LM	875LM	1056LM	1304LM
CCT (K)	3000K	3000 / 4000K	3000K	3000 / 4000K
CRI (Ra)	90	90	90	90
BEAM ANGLE	180°	180°	180°	180°
OPERATING VOLTAGE-VAC	220-240V	220-240V	220-240V	220-240V
SOURCE POWER (W)	5.8W	11.2W	19.2W	23.7W
DIMMING RANGE	N/A	30-100%	N/A	N/A
FLICKER FACTOR	342.86HZ / 6.74%	100.67HZ / 2.13%	100HZ / 1.63%	101.35HZ / 1.25%
WEIGHT (KG)	0.54KG	1KG	1.71KG	1.95KG
DIMENSIONS	D:φ110 x H:110mm	D:φ160 x H:110mm	D:φ260 x H:135.8mm	D:φ350 x H:135.8mm

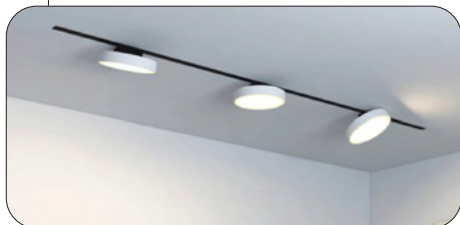

- CD / KLM
- C0 - C180
 - C90 - C270

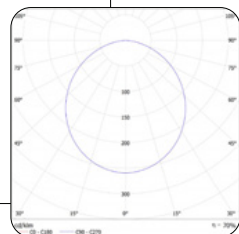

E&OE MAY OCCUR

REVOC MINI 2000

TRACK LIGHT

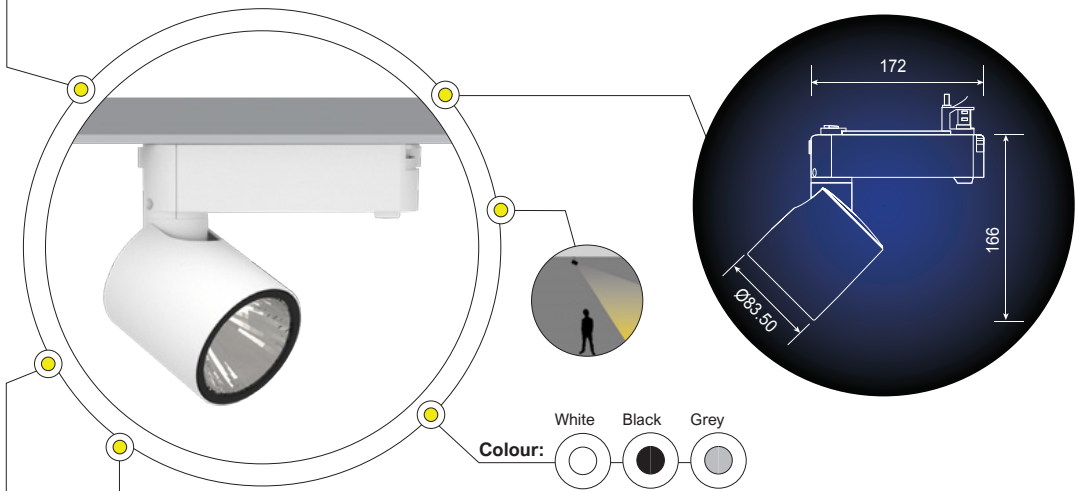

+ IP 20



LOA

5 YRS

ldt



PHYSICAL DATA

FEATURES

- Material: Die-cast aluminium
- Optics: Metalized aluminium reflector
- Track light with incorporated electronic gear and chip on board
- High quality reflectors with three different beam spreads
- Lamp housing of die-cast aluminium for optimal cooling, long lifetime and low weight
- Black front ring
- Adjustable with 90° tilt and 355° rotation capability

OPTIONS & ACCESSORIES

- Product available with food CCT and other Kelvin temperatures on request
- Accessories include Barn doors, Honeycomb filter, Filter holder and Asymmetric glass
- Surface mount and Hanger Bracket accessories optional

MOUNTING: Track

APPLICATION AREAS: Indoor, Commercial, Retail

TECHNICAL DATA

N28551

LAMP	LED
TOTAL POWER (W)	17W
SYSTEM OUTPUT (LM)	1890LM
EFFICACY (LM/W)	111
CCT (K)	3000 / 3500 / 4000K
CRI (Ra)	>90
BEAM ANGLE	16° / 28° / 40°
OPERATING VOLTAGE-VAC	220-240V
RATED LIFE (HRS)	50 000HRS
LUMEN MAINTENANCE	L70B50 @ 50 000HRS
MAC ADAM STEP	3SDCM
WEIGHT (KG)	0.76KG
DIMENSIONS	D:Ø83.5 x W:172 x H:166mm

NOTE - Please specify required beam angle when ordering

Spot		Medium		Flood	
16°		28°		40°	
m	Ø	m	Ø	m	Ø
1.0	0.28	1.0	0.50	1.0	0.73
2.0	0.56	2.0	1.00	2.0	1.46
3.0	0.83	3.0	1.51	3.0	2.18

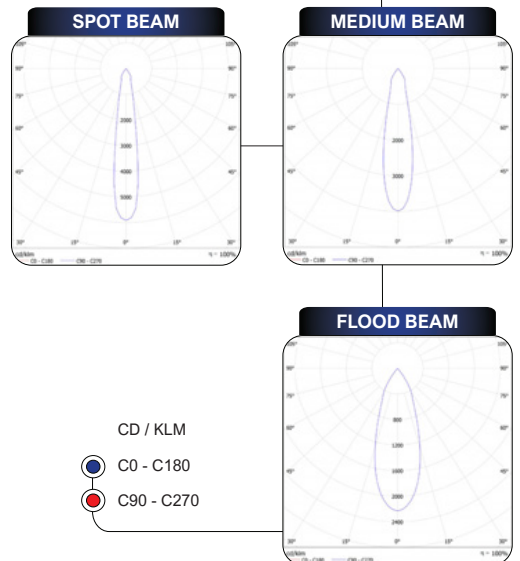

E&OE MAY OCCUR

ULTRA MINI 1500

TRACK LIGHT

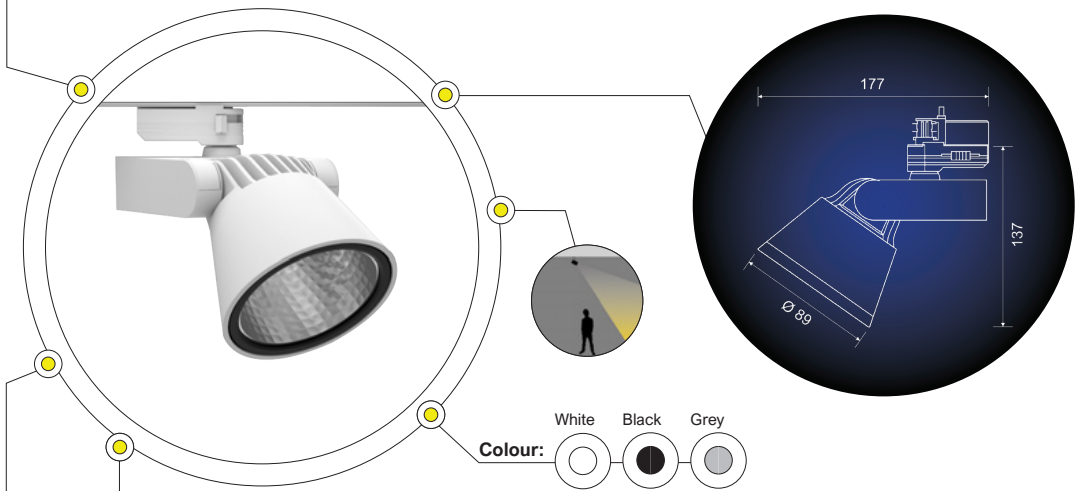

+ IP 20



LOA

5 YRS

ldt



PHYSICAL DATA

FEATURES

- Material: Die-cast aluminium
- Metalized aluminium reflector
- Track light with incorporated electronic gear and chip on board
- High quality reflectors with four different beam spreads
- Lamp housing of die-cast aluminium for optimal cooling, long lifetime and low weight
- Black front ring
- Adjustable with 90° tilt and 355° rotation capability

OPTIONS & ACCESSORIES

- Product available in other Kelvin temperatures on request
- Accessories include Diffuser glass and Asymmetric glass
- Surface mount and Hanger Bracket accessories optional

MOUNTING: Track

APPLICATION AREAS: Indoor, Commercial, Retail

TECHNICAL DATA

N27750

LAMP	LED
TOTAL POWER (W)	12W
SYSTEM OUTPUT (LM)	1380LM
EFFICACY (LM/W)	115
CCT (K)	3000 / 4000K
CRI (Ra)	>90
BEAM ANGLE	16° / 28° / 40°
OPERATING VOLTAGE-VAC	220-240V
RATED LIFE (HRS)	50 000HRS
LUMEN MAINTENANCE	L70B50 @ 50000HRS
MAC ADAM STEP	3SDCM
WEIGHT (KG)	0.76KG
DIMENSIONS	D:Ø89 x W:177 x H:137mm

NOTE - Please specify required beam angle when ordering

Spot		Medium		Flood	
m	Ø	m	Ø	m	Ø
1.0	0.28	1.0	0.50	1.0	0.73
2.0	0.56	2.0	1.00	2.0	1.46
3.0	0.83	3.0	1.51	3.0	2.18

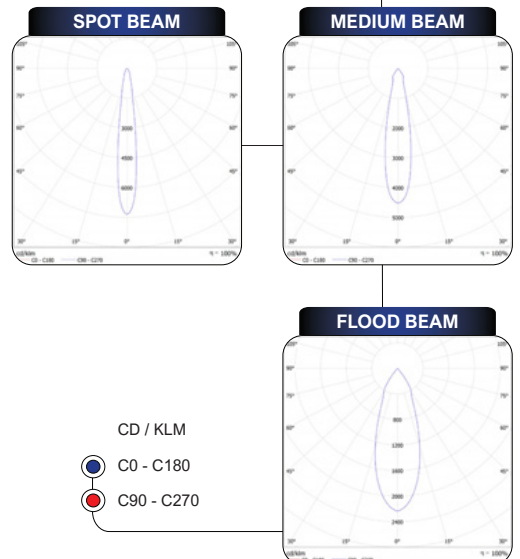

E&OE MAY OCCUR

ZEN MINI 3000

TRACK LIGHT

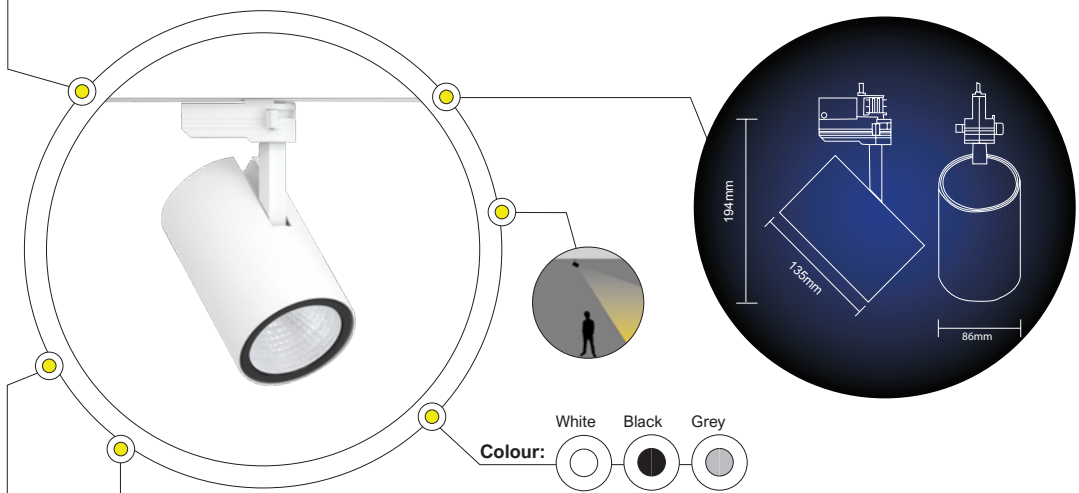

+ IP 20



LOA

5 YRS

ldt



PHYSICAL DATA

FEATURES

- Material: Die-cast aluminium
- Metalized aluminium reflector
- Track light with incorporated electronic gear and chip on board
- High quality reflectors with three different beam spreads
- Lamp housing of die-cast aluminium for optimal cooling, long lifetime and low weight
- Adjustable with 90° tilt and 355° rotation capability

OPTIONS & ACCESSORIES

- Product available in other Kelvin temperatures on request
- Accessories include Anti-dazzle snoot, Barn doors, Honeycomb filter, Filter holder and Asymmetric Glass
- Surface mount and Hanger Bracket accessories optional

MOUNTING: Track

APPLICATION AREAS: Indoor, Commercial, Retail

TECHNICAL DATA

N32550

LAMP	LED
TOTAL POWER (W)	24W
SYSTEM OUTPUT (LM)	2800LM
EFFICACY (LM/W)	114
CCT (K)	3000 / 4000K
CRI (Ra)	>90
BEAM ANGLE	18° / 31° / 42°
OPERATING VOLTAGE-VAC	220-240V
RATED LIFE (HRS)	50 000HRS
LUMEN MAINTENANCE	L70B50 @ 50000HRS
MAC ADAM STEP	3SDCM
WEIGHT (KG)	0.65KG
DIMENSIONS	D:φ86 x W:135 x H:194mm

NOTE - Please specify required beam angle when ordering

Spot		Medium		Flood	
18°		31°		42°	
m	Ø	m	Ø	m	Ø
1.0	0.31	1.0	0.52	1.0	0.76
2.0	0.62	2.0	1.05	2.0	1.52
3.0	0.93	3.0	1.57	3.0	2.28

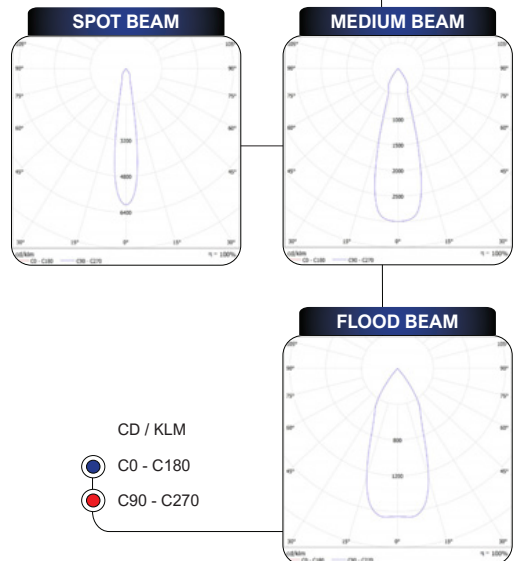

> 3-CIRCUIT TRACK SPOTS

GU10

TRACK & TRACK SPOTS - 3CIRCUIT TRACK SPOTS - GU10



DANNY MINI AIR T

GU10 TRACK SPOT

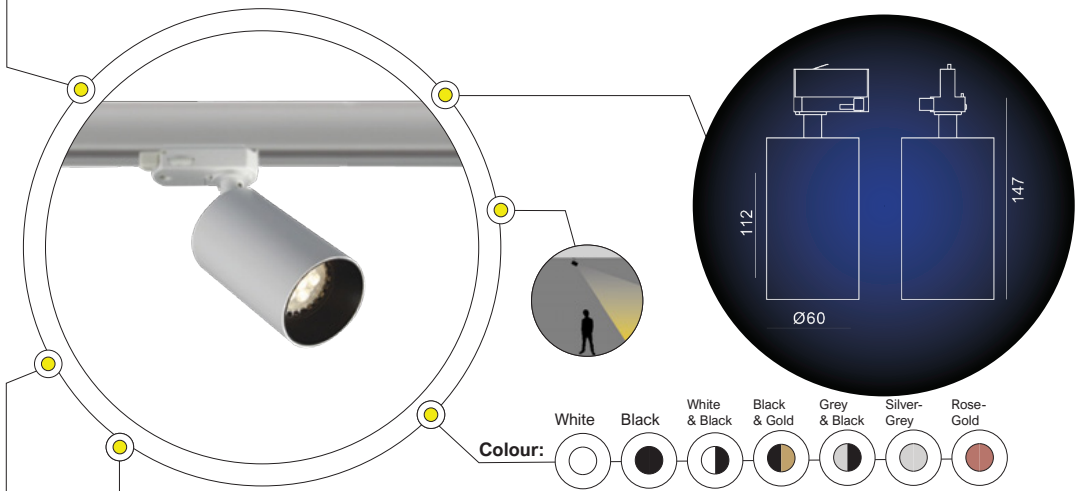

+ IP 20



LOA

3 YRS



90°

350°

PHYSICAL DATA

FEATURES

- Material: Die-cast aluminium
- Track spot; adjustable with spot-head adjust of 90° tilt and 350° rotation

MOUNTING

Track

APPLICATION AREAS

Indoor, Commercial, Residential, Retail, Hospitality, Galleries

TECHNICAL DATA

LTL23GU1031

LAMP HOLDER	GU10 x1
TOTAL POWER (W)	7.5W max
OPERATING VOLTAGE-VAC	220-240V
DIMENSIONS	D:φ60 x H:98mm

LAMP DATA

LPPAR165036

LAMP	LED
DIMMABLE	YES
BASE	GU10
TOTAL POWER (W)	5.5W
SYSTEM OUTPUT (LM)	380 / 400LM
CCT (K)	3000 / 4000 / 6500K
CRI (Ra)	90
BEAM ANGLE	36°
OPERATING VOLTAGE	220-240V
RATED LIFE (HRS)	25 000HRS
DIMENSIONS	D:φ51 x H:52mm



PLEASE NOTE

Lamp specifications and lamp warranties may differ

E&OE MAY OCCUR

LTL18GU10

GU10 TRACK SPOT

TRACK & TRACK SPOTS - ICIRCUIT 3WIRE TRACK - LTL18GU10

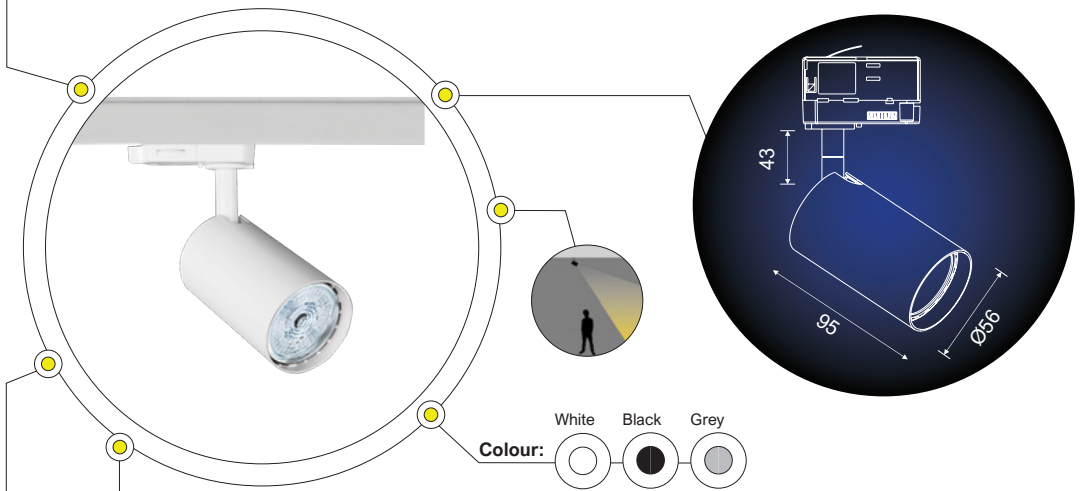

- + IP 20
-
- LOA
- 5 YRS
-
-
-

PHYSICAL DATA

FEATURES

- Material: Die-Cast Aluminium
- No Driver needed for AC Source
- Simple and Economic
- Adjustable, Easy Installation and High performance
- Better heat dissipation with higher density aluminium alloy

FEATURES

- Only use LED globes
- Not compatible with halogen globes

MOUNTING

Track

APPLICATION AREAS

Indoor, Commercial, Residential, Retail, Hospitality

TECHNICAL DATA

LTL18GU10

LAMP HOLDER	GU10
TOTAL POWER (W)	7.5W max
OPERATING VOLTAGE-VAC	220-240V
DIMENSIONS	D:φ56 x L:95 x H:43mm

LAMP DATA

LPPAR165036

LAMP	LED
DIMMABLE	YES
BASE	GU10
TOTAL POWER (W)	5.5W
SYSTEM OUTPUT (LM)	380 / 400LM
CCT (K)	3000 / 4000 / 6500K
CRI (Ra)	90
BEAM ANGLE	36°
OPERATING VOLTAGE	220-240V
RATED LIFE (HRS)	25 000HRS
DIMENSIONS	D:φ51 x H:52mm



PLEASE NOTE

Lamp specifications and lamp warranties may differ

E&OE MAY OCCUR

> LUNA S SURFACE MAGNETIC

COMMERCIAL & ARCHITECTURAL



Project 169 on Main / Design: Bone Interior Design Studio

TRACK & TRACK SPOTS - MAGNETIC TRACKS - LUNA S SURFACE

LUNA S ON MAGNETIC TRACK

SURFACE MAGNETIC TRACK SYSTEM

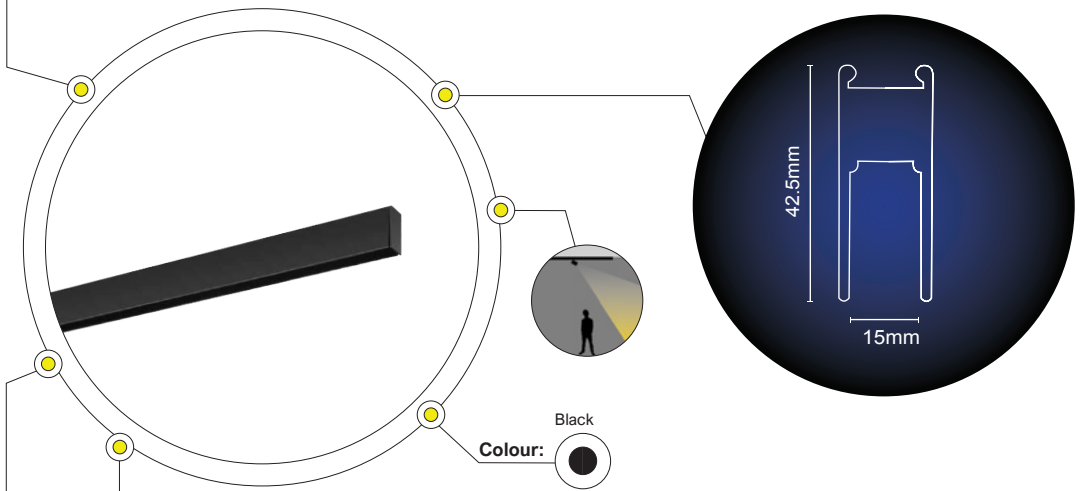

+ IP 20



LOA

3 YRS

PHYSICAL DATA

FEATURES

- Material: Aluminium
- Magnetic installation of luminaires
- 48V allows for longer installation runs and affords more fittings per run
- Non-dimmable remote driver required

OPTIONS & ACCESSORIES

- The LUNA S DC Recessed Magnetic Track System

available

- The LUNA M Magnetic Track system available

MOUNTING

Recessed Track

APPLICATION AREAS

Indoor, Commercial, Residential, Retail, Hospitality, Museums, Galleries, Cultural Centres

TECHNICAL DATA

POWER SUPPLY FEED

	LF001584	LF001574	LF001575	LF001576	LF001577
OPERATING VOLTAGE	48V	48V	48V	48V	48V
MODEL	S ON DC-24/48-0.5M	S ON DC-24/48-1M	S ON DC-24/48-1.5M	S ON DC-24/48-2M	S ON DC-24/48-2.5M
DIMENSIONS	500 x 42.3 x 18mm	1000 x 42.3 x 18mm	1500 x 42.3 x 18mm	2000 x 42.3 x 18mm	2500 x 42.3 x 18mm

INTERMEDIATE TRACK

	LF001585	LF001579	LF001580	LF001581	LF001582
OPERATING VOLTAGE	48V	48V	48V	48V	48V
MODEL	S ON DC-24/48-0.5M	S ON DC-24/48-1M	S ON DC-24/48-1.5M	S ON DC-24/48-2M	S ON DC-24/48-2.5M
DIMENSIONS	500 x 42.3 x 18mm	1000 x 42.3 x 18mm	1500 x 42.3 x 18mm	2000 x 42.3 x 18mm	2500 x 42.3 x 18mm

E&OE MAY OCCUR

LUNA S ON MAGNETIC TRACK

ACCESSORIES



**LUNA S ON CORNER L1
LF001586**

MODEL	S DC-24/48-L1
OPERATING VOLTAGE	48V
COLOURS	BLACK
WARRANTY	3 YRS
DIMENSIONS	150 x 150 x 18mm

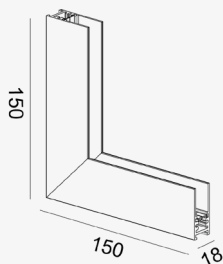

**LUNA S ON CORNER L2
LF001587**

MODEL	S DC-24/48-L2
OPERATING VOLTAGE	48V
COLOURS	BLACK
WARRANTY	3 YRS
DIMENSIONS	150 x 150 x 42.3mm

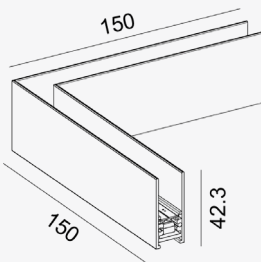

**LUNA S ON MOUNT CLIP L3
LF001589**

MODEL	S DC-24/48-L3
OPERATING VOLTAGE	48V
COLOURS	BLACK / WHITE
WARRANTY	3 YRS
DIMENSIONS	68 x 12.3 x 6mm

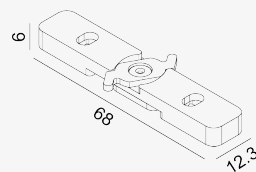

Project: I89 on Main / Design: Bone Interior Design Studio

E&OE MAY OCCUR

LUNA S ON MAGNETIC TRACK

ACCESSORIES

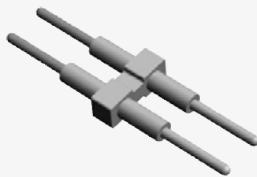

**LUNA S ON CONNECTOR
LF001377**

MODEL	S DC-24/48-I
OPERATING VOLTAGE	24V / 48V
COLOURS	BLACK
WARRANTY	3 YRS
DIMENSIONS	100 x 27 x 11.3mm

**LUNA S/M PIN
LF001680**

MODEL	S/M PIN
OPERATING VOLTAGE	48V
COLOURS	CREAM
WARRANTY	3 YRS
DIMENSIONS	26 x 7.5 x 2.8mm

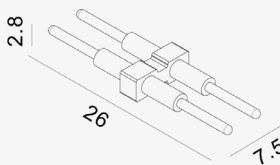
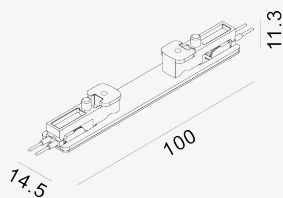

E&OE MAY OCCUR

> LUNA S RECESSED MAGNETIC

COMMERCIAL & ARCHITECTURAL



LUNA S DC MAGNETIC TRACK

RECESSED MAGNETIC TRACK SYSTEM

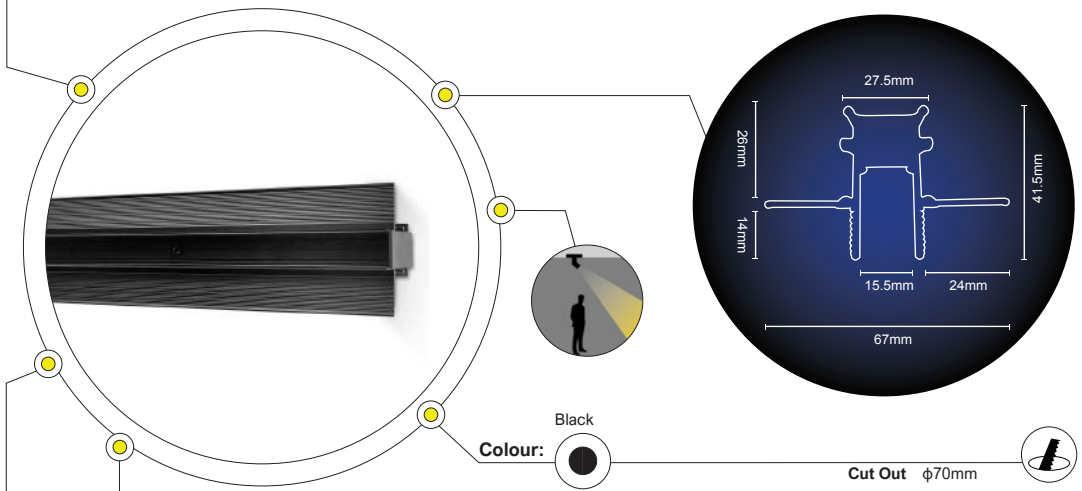

+ IP 20



LOA

3 YRS

PHYSICAL DATA

FEATURES

- Material: Aluminium
- Magnetic installation of luminaires
- 48V allows for longer installation runs and affords more fittings per run
- Recessed slimline profile lends itself toward dynamic architectural interest
- Non-dimmable remote driver required

OPTIONS & ACCESSORIES

- The LUNA S ON Surface Magnetic Track System available
- The LUNA M Magnetic Track system available

MOUNTING: Recessed Track

APPLICATION AREAS: Indoor, Commercial, Residential, Retail, Hospitality, Museums, Galleries, Cultural Centres

TECHNICAL DATA

POWER SUPPLY FEED

	LF001569	LF001290	LF001291	LF001292	LF001293
OPERATING VOLTAGE	48V	48V	48V	48V	48V
MODEL	S DC-24/48-0.5M	S DC-24/48-1M	S DC-24/48-1.5M	S DC-24/48-2M	S DC-24/48-2.5M
DIMENSIONS	500 x 66.8 x 41.5mm	1000 x 66.8 x 41.5mm	1500 x 66.8 x 41.5mm	2000 x 66.8 x 41.5mm	2500 x 66.8 x 41.5mm
CUT OUT SIZE	500 x 35mm	1000 x 35mm	1500 x 35mm	2000 x 35mm	2500 x 35mm

INTERMEDIATE TRACK

	LF001570	LF001297	LF001298	LF001299	LF001300
OPERATING VOLTAGE	48V	48V	48V	48V	48V
MODEL	S DC-24/48C-0.5M	S DC-24/48C-1M	S DC-24/48C-1.5M	S DC-24/48C-2M	S DC-24/48C-2.5M
DIMENSIONS	500 x 66.8 x 41.5mm	1000 x 66.8 x 41.5mm	1500 x 66.8 x 41.5mm	2000 x 66.8 x 41.5mm	2500 x 66.8 x 41.5mm
CUT OUT SIZE	500 x 35mm	1000 x 35mm	1500 x 35mm	2000 x 35mm	2500 x 35mm

E&OE MAY OCCUR

LUNA S DC MAGNETIC TRACK

ACCESSORIES



LUNA S DC CORNER L1
LF001374

MODEL	S DC-24/48-L1
OPERATING VOLTAGE	48V
COLOURS	BLACK
WARRANTY	3 YRS
DIMENSIONS	149 x 149 x 66.8mm

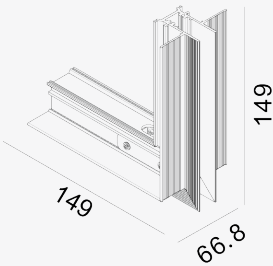

LUNA S DC CORNER L2
LF001375

MODEL	S DC-24/48-L2
OPERATING VOLTAGE	48V
COLOURS	BLACK
WARRANTY	3 YRS
DIMENSIONS	149 x 149 x 66.8mm

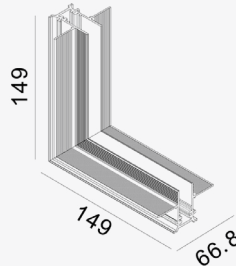

LUNA S DC CORNER L3
LF001376

MODEL	S DC-24/48-L3
OPERATING VOLTAGE	48V
COLOURS	BLACK
WARRANTY	3 YRS
DIMENSIONS	174.5 x 174.5 x 41.5mm

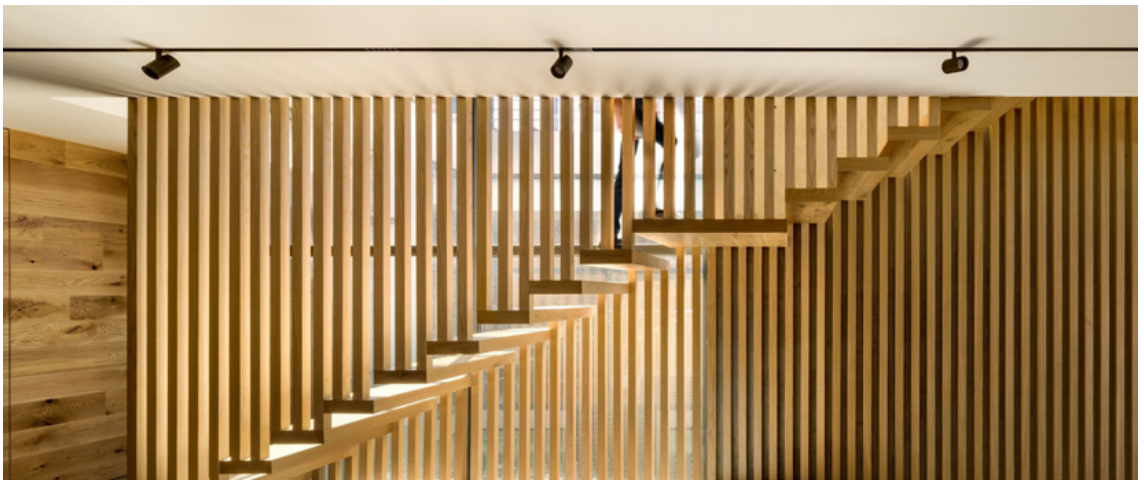
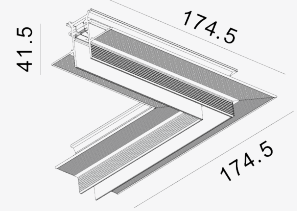

E&OE MAY OCCUR

LUNA S DC MAGNETIC TRACK

ACCESSORIES

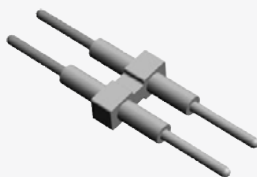

LUNA S DC CONNECTOR LF001377	
MODEL	S DC-24/48-I
OPERATING VOLTAGE	24V / 48V
COLOURS	BLACK
WARRANTY	3 YRS
DIMENSIONS	100 x 27 x 11.3mm

LUNA S/M PIN LF001680	
MODEL	S/M PIN
OPERATING VOLTAGE	48V
COLOURS	CREAM
WARRANTY	3 YRS
DIMENSIONS	26 x 7.5 x 2.8mm

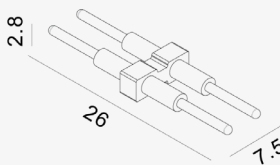
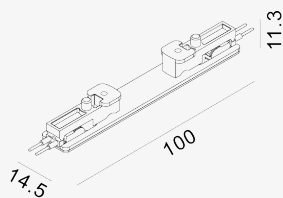

E&OE MAY OCCUR

TRACK & TRACK SPOTS - MAGNETIC TRACKS - LUNA S RECESSED - ACCESSORIES

> LUNA S TRACK SPOTS

COMMERCIAL & ARCHITECTURAL



AHRI CS IN SPOT 3

TRACK SPOT FOR LUNA S

TRACK & TRACK SPOTS - MAGNETIC TRACKS - LUNA S - TRACK SPOTS - ARCA CS IN SPOT 3

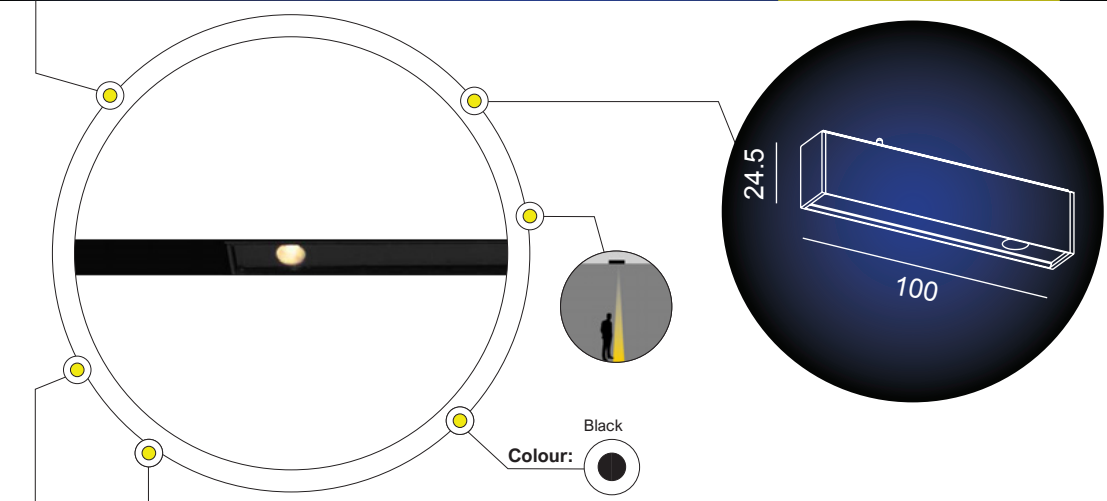

- + IP 20
- LOA
- 3 YRS
- ldt

PHYSICAL DATA

FEATURES

- Material: Aluminium
- The AHRI CS IN SPOT 3, a spotlight, is used with the Luna S Magnetic Track
- This embedded installation is flush with the track
- LUNA is a compact and comprehensive lighting track system with magnetically installed luminaires.
- Not dimmable

OPTIONS & ACCESSORIES

- The AHRI CS IN SPOT 3X1, a 3-spot option available

MOUNTING

Track, Luna S

APPLICATION AREAS

Indoor, Commercial, Residential, Hospitality, Retail

TECHNICAL DATA

LF520317

LAMP	LED
TOTAL POWER (W)	2.1W
SYSTEM OUTPUT (LM)	79LM
CCT (K)	2700 / 3000 / 3500 / 4000K
CRI (Ra)	90
BEAM ANGLE	20°
OPERATING VOLTAGE-VAC	48VDC
SOURCE POWER (W)	3.5W
SOURCE OUTPUT (LM)	199LM
DIMENSIONS	L:100 x H:24.5 x W:14.5mm



- CD / KLM
- C0 - C180
- C90 - C270

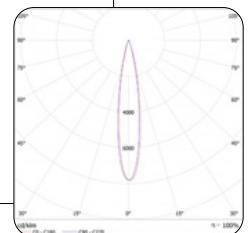

E&OE MAY OCCUR

AHRI CS IN SPOT 3X1

TRACK SPOT FOR LUNA S

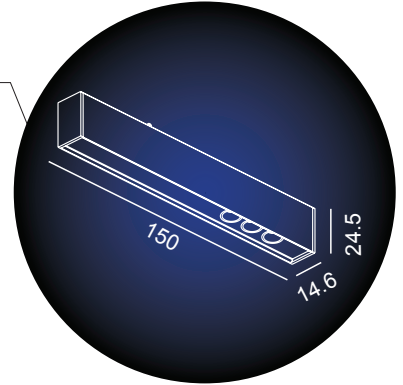
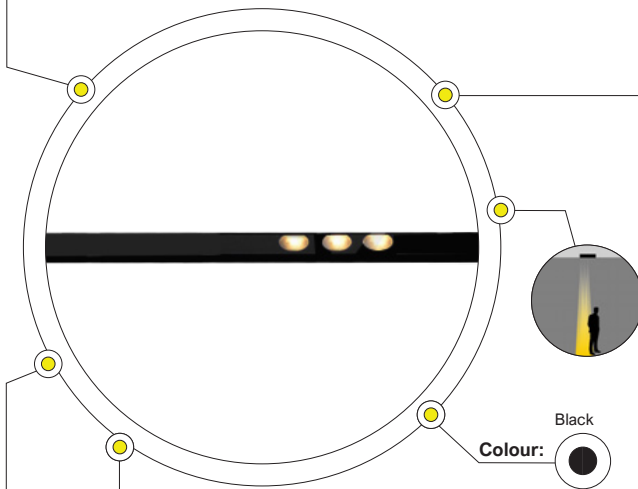

+ IP 20



LOA

3 YRS

ldt

PHYSICAL DATA

FEATURES

- Material: Aluminium
- The AHRI CS IN SPOT 3X1, a spotlight, is used with the Luna S Magnetic Track
- This embedded installation is flush with the track
- LUNA is a compact and comprehensive lighting track system with magnetically installed luminaires
- Not dimmable

OPTIONS & ACCESSORIES

- The AHRI CS IN SPOT, is a single spot option available

MOUNTING

Track, Luna S

APPLICATION AREAS

Indoor, Commercial, Residential, Hospitality, Retail

TECHNICAL DATA

LF522217

LAMP	LED
TOTAL POWER (W)	3.15W
SYSTEM OUTPUT (LM)	192LM
CCT (K)	2700 / 3000 / 3500 / 4000K
CRI (Ra)	90
BEAM ANGLE	18°
OPERATING VOLTAGE-VAC	48VDC
SOURCE POWER (W)	3.7W
SOURCE OUTPUT (LM)	306LM
DIMENSIONS	L:150 x H:24.5 x W:14.6mm

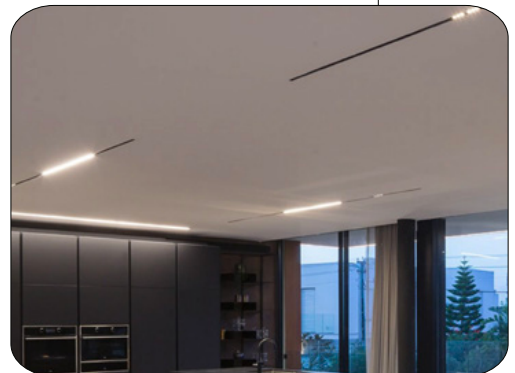

- CD / KLM
- C0 - C180
 - C90 - C270

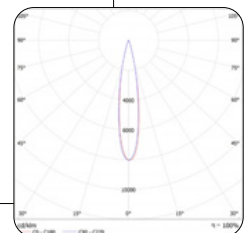

E&OE MAY OCCUR

ARCA CS SPOT 7

TRACK SPOT FOR LUNA S

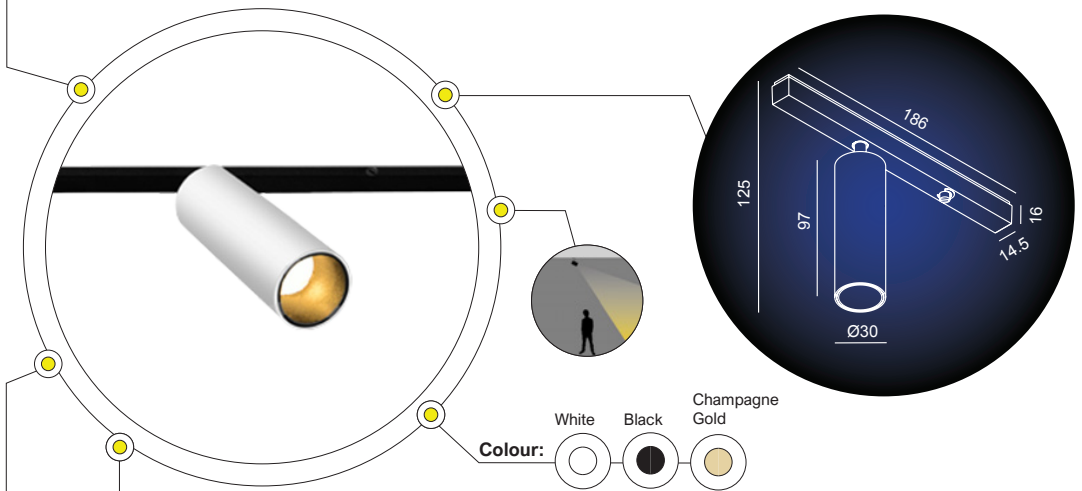

+ IP 20



LOA

3 YRS

ldt



PHYSICAL DATA

FEATURES

- Material: Aluminium
- The ARCA, a spotlight, is used with the Luna S Magnetic Track
- LUNA is a compact and comprehensive lighting track system with magnetically installed luminaires
- Adjustable with a 90° tilt and 320° rotation of the spot head
- Dimming control on the body of spot itself

OPTIONS & ACCESSORIES

- Available in 11.6W, ϕ 42mm diameter lens
- Options in ARCA range available for mounting with the LUCA S track system

MOUNTING: Track, Luna S

APPLICATION AREAS

Indoor, Commercial, Residential, Hospitality, Retail

TECHNICAL DATA

LF527611

LAMP	LED
TOTAL POWER (W)	5.4W
SYSTEM OUTPUT (LM)	380LM
CCT (K)	2700 / 3000 / 3500 / 4000K
CRI (Ra)	80
BEAM ANGLE	14°
OPERATING VOLTAGE-VAC	48VDC
SOURCE POWER (W)	6.8W
SOURCE OUTPUT (LM)	467LM
CURRENT (MA)	450MA
DIMENSIONS	D: ϕ 30 x H:125 x L:186mm

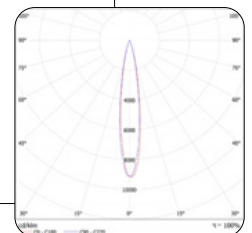
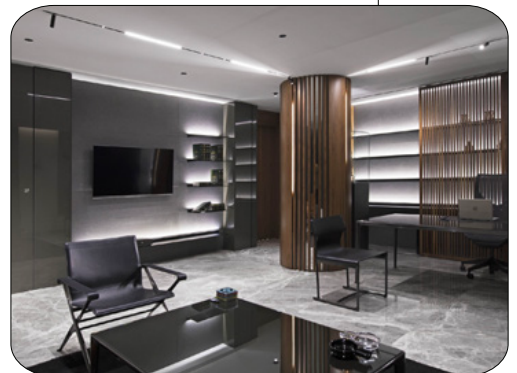

E&OE MAY OCCUR

ARCA CS SPOT 10

TRACK SPOT FOR LUNA S

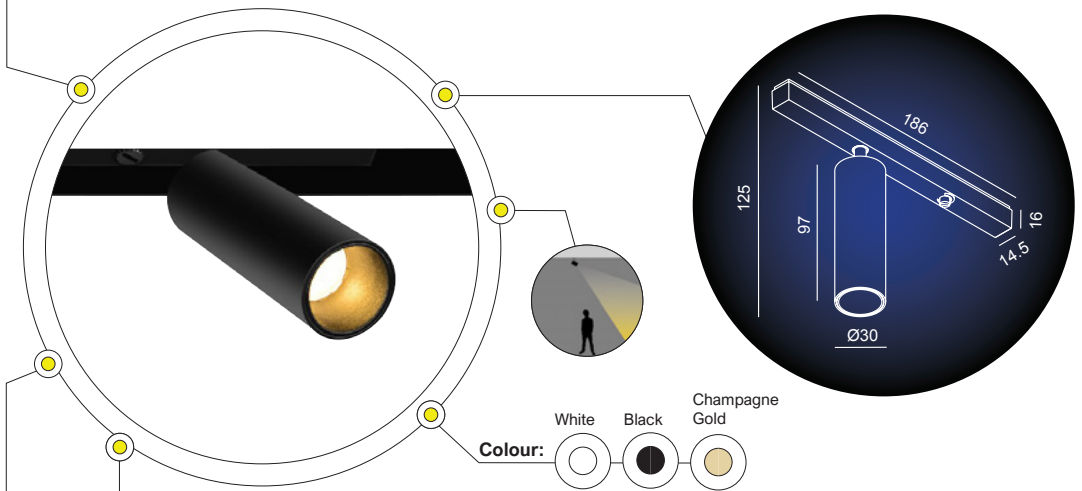

+ IP 20



LOA

3 YRS

ldt



PHYSICAL DATA

FEATURES

- Material: Aluminium
- The ARCA, a spotlight, is used with the Luna S Magnetic Track
- LUNA is a compact and comprehensive lighting track system with magnetically installed luminaires
- Adjustable
- Dimming control on the body of spot itself

OPTIONS & ACCESSORIES

- Available in 5.4W, ϕ 30mm diameter lens
- Available in 11.6W, ϕ 42mm diameter lens

MOUNTING: Track, Luna S

APPLICATION AREAS

Indoor, Commercial, Residential, Hospitality, Retail

TECHNICAL DATA

LF521311

LAMP	LED
TOTAL POWER (W)	8.4W
SYSTEM OUTPUT (LM)	420LM
CCT (K)	2700 / 3000 / 4000K
CRI (Ra)	90
BEAM ANGLE	14°
OPERATING VOLTAGE-VAC	48V
SOURCE POWER (W)	9.7W
SOURCE OUTPUT (LM)	640LM
DIMMING RANGE	30-100%
DIMENSIONS	D: ϕ 30 x H:125 x L:186mm



- CD / KLM
- C0 - C180
 - C90 - C270

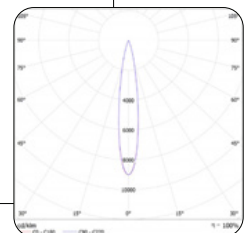

E&OE MAY OCCUR

ARCA CS SPOT 12

TRACK SPOT FOR LUNA S

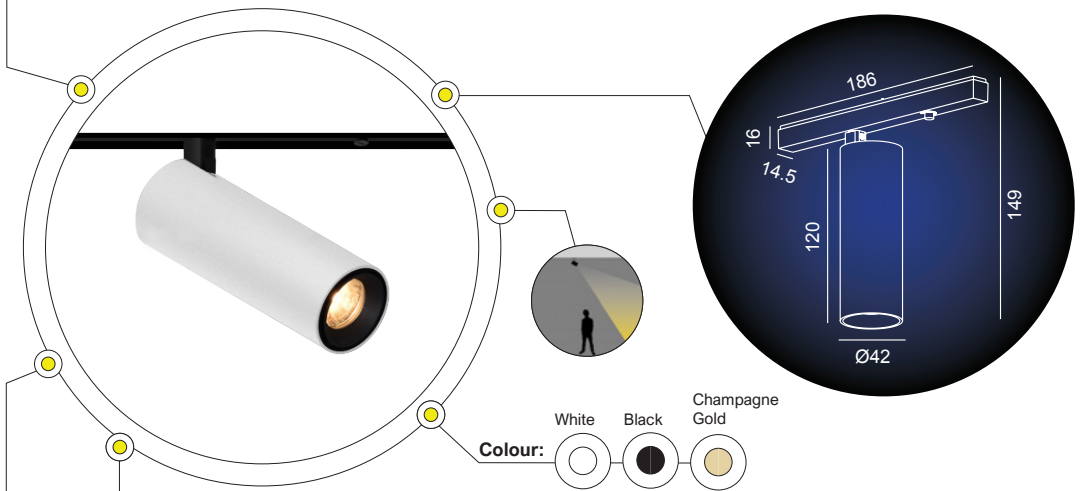

PHYSICAL DATA

FEATURES

- Material: Aluminium
- The ARCA, a spotlight, is used with the Luna S Magnetic Track
- LUNA is a compact and comprehensive lighting track system with magnetically installed luminaires
- Adjustable with a 90° tilt and 320° rotation
- Dimming control on the body of spot itself

OPTIONS & ACCESSORIES

- Available in 5.4W, ϕ 30mm diameter lens

MOUNTING

Track, Luna S

APPLICATION AREAS

Indoor, Commercial, Residential, Hospitality, Retail

+ IP 20



LOA

3 YRS

ldt



TECHNICAL DATA

LF522015E

LAMP	LED
TOTAL POWER (W)	10.8W
SYSTEM OUTPUT (LM)	683LM
CCT (K)	2700 / 3000 / 4000K
CRI (Ra)	90
BEAM ANGLE	26°
OPERATING VOLTAGE-VAC	48V
SOURCE POWER (W)	11.6W
SOURCE OUTPUT (LM)	999LM
DIMMING RANGE	30-100%
FLICKER FACTOR	25.43HZ / 0.2%
DIMENSIONS	D: ϕ 42 x H:120 x L:186mm

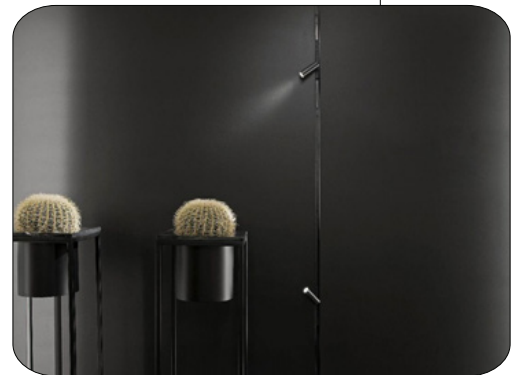

- CD / KLM
- C0 - C180
 - C90 - C270

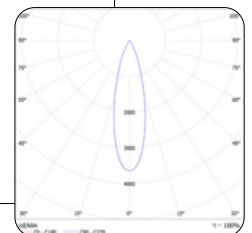

E&OE MAY OCCUR

ELF CS

TRACK SPOT FOR LUNA S

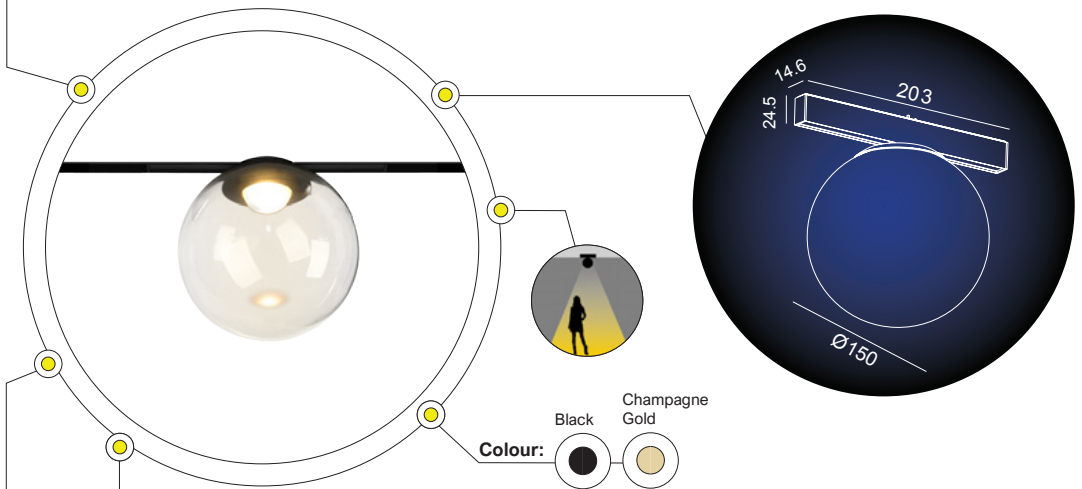

+ IP 20



LOA

3 YRS

PHYSICAL DATA

FEATURES

- Material: Aluminium and glass
- Part of the LUNA S Magnetic Track System
- This is a decorative light for the Luna S Track System
- It is beautiful and practical and suitable for both commercial and residential spaces
- This simple and delicate transparent orb creates unique lighting patterns and is ideal for any space
- Not dimmable

OPTIONS & ACCESSORIES

- The ELF is available as a pendant and decorative spot for the Luca and the Armo track systems
- Also available as an indoor or as an outdoor wall light

MOUNTING: Track, Luna S

APPLICATION AREAS: Indoor, Commercial, Residential, Hospitality, Retail

TECHNICAL DATA

LF523619E

LAMP	LED
TOTAL POWER (W)	6W
SYSTEM OUTPUT (LM)	421LM
CCT (K)	3000K
CRI (Ra)	90
BEAM ANGLE	180°
OPERATING VOLTAGE-VAC	48VDC
SOURCE POWER (W)	7.5W
SOURCE OUTPUT (LM)	623LM
WEIGHT (KG)	0.52KG
DIMENSIONS	L:203 x H:190 x D:φ150mm

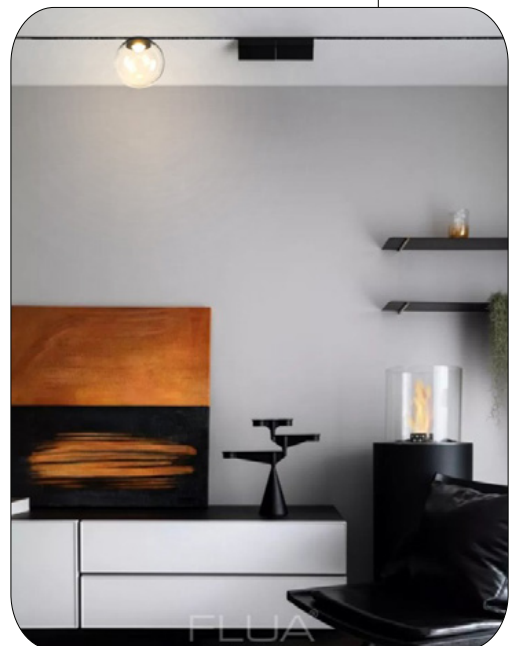

E&OE MAY OCCUR

FAVOR CS S

TRACK SPOT FOR LUNA S

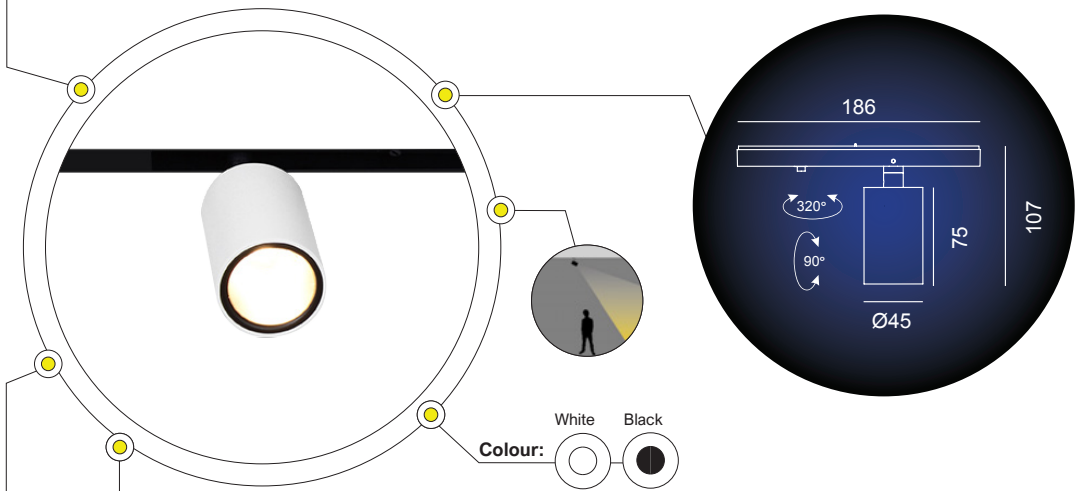

+ IP 20



LOA

3 YRS

ldt



PHYSICAL DATA

FEATURES

- Material: Aluminium
- The FAVOR CS S, a spotlight, is used with the Luna S Magnetic Track; LUNA is a compact and comprehensive lighting track system with magnetically installed luminaires
- Sharp minimalist design also provides style and elegance, suitable for any project
- Adjustable with a 90° tilt and 320° rotation of the spot

head

- Dimming control on the body of spot itself

MOUNTING

Track, Luna S

APPLICATION AREAS

Indoor, Commercial, Residential, Hospitality, Retail

TECHNICAL DATA

LF531019ETD

LAMP	LED
TOTAL POWER (W)	9W
SYSTEM OUTPUT (LM)	388LM
CCT (K)	2700 / 3000 / 3500 / 4000K
CRI (Ra)	80
BEAM ANGLE	28°

OPERATING VOLTAGE-VAC	48VDC
SOURCE POWER (W)	9.6W
SOURCE OUTPUT (LM)	957LM
DIMMING RANGE	30-100%
CURRENT (MA)	500MA
DIMENSIONS	D:φ45 x H:75 x L:186mm

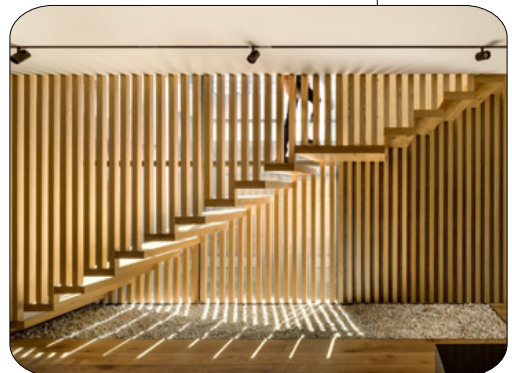

- CD / KLM
- C0 - C180
 - C90 - C270

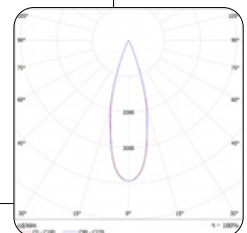

E&OE MAY OCCUR

FLAT CS

FLOODLIGHT FOR LUNA S

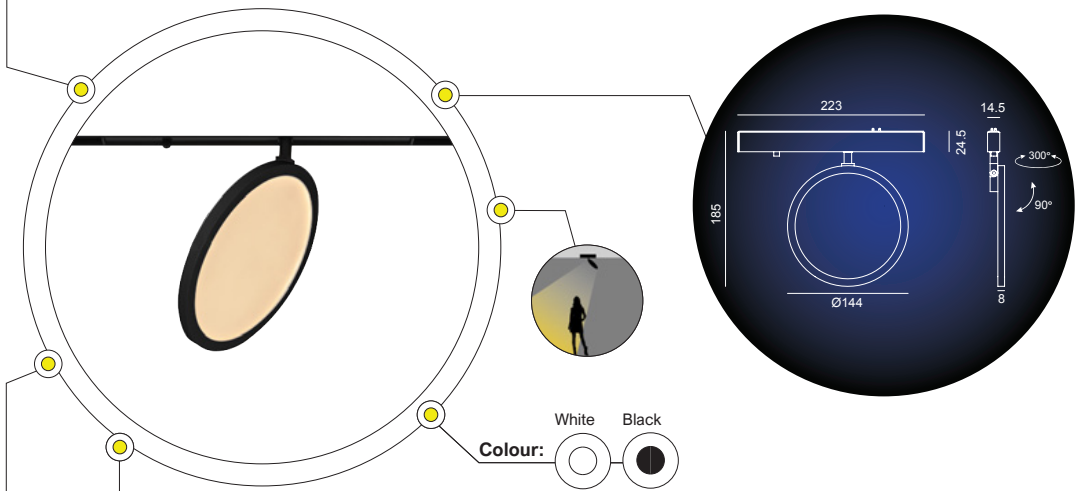

+ IP 20



LOA

3 YRS



PHYSICAL DATA

FEATURES

- Material: Aluminium and glass
- Part of the LUNA S Magnetic Track System
- The FLAT CS is an ultra slim disc-shaped adjustable decorative flood light
- Not dimmable

Luca and the Armo track systems

- The FLAT is also available as a surface and recessed downlight

MOUNTING: Track, Luna S

APPLICATION AREAS

Indoor, Commercial, Residential, Hospitality, Retail

OPTIONS & ACCESSORIES

- The FLAT is also available as a decorative spot for the

TECHNICAL DATA

LF523414

LAMP	LED
TOTAL POWER (W)	11.2W
SYSTEM OUTPUT (LM)	611LM
CCT (K)	2700 / 3000 / 4000K
CRI (Ra)	90
BEAM ANGLE	180°
OPERATING VOLTAGE-VAC	48VDC
SOURCE POWER (W)	14 W
DIMMING RANGE	30-100%
WEIGHT (KG)	0.35KG
DIMENSIONS	L:223 x H:185 x W:24.5mm
LUMINAIRE DIAMETER	D:φ144mm

HUNTER CS M

TRACK SPOT FOR LUNA S

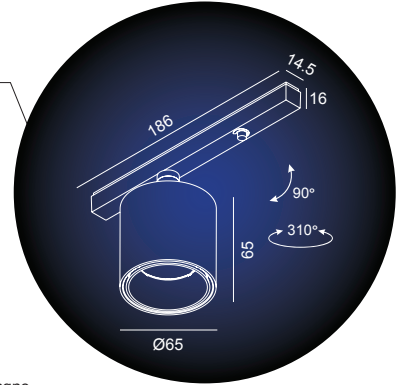
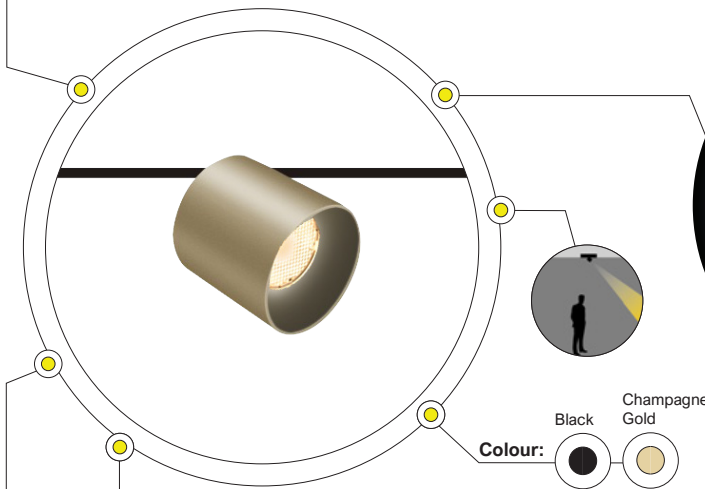

PHYSICAL DATA

FEATURES

- Material: Aluminium
- The HUNTER CS M, a miniature track spotlight, is used with the Luna S Magnetic Track System
- The HUNTER CS M offers a narrow beam angle ideal for highlighting objects in the space
- Adjustable with a 90° tilt and 310° rotation of the spot head
- Dimming control on the body of spot itself

OPTIONS & ACCESSORIES

- The HUNTER KS M is available for the Luca S Track System

MOUNTING

Track, Luna S

APPLICATION AREAS

Indoor, Commercial, Residential, Hospitality, Retail

+ IP 20



LOA

3 YRS

ldt



TECHNICAL DATA

LF521911

LAMP	LED
TOTAL POWER (W)	8.2W
SYSTEM OUTPUT (LM)	466LM
CCT (K)	2700 / 3000 / 3500 / 4000K
CRI (Ra)	90
BEAM ANGLE	6°

OPERATING VOLTAGE-VAC	48VDC
SOURCE POWER (W)	8.2W
SOURCE OUTPUT (LM)	756LM
DIMMING RANGE	30-100%
WEIGHT (KG)	0.28KG
DIMENSIONS	D:φ65 x L:65mm

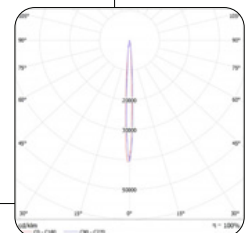

E&OE MAY OCCUR

MOONLINE CS

TRACK LIGHT FOR LUNA S

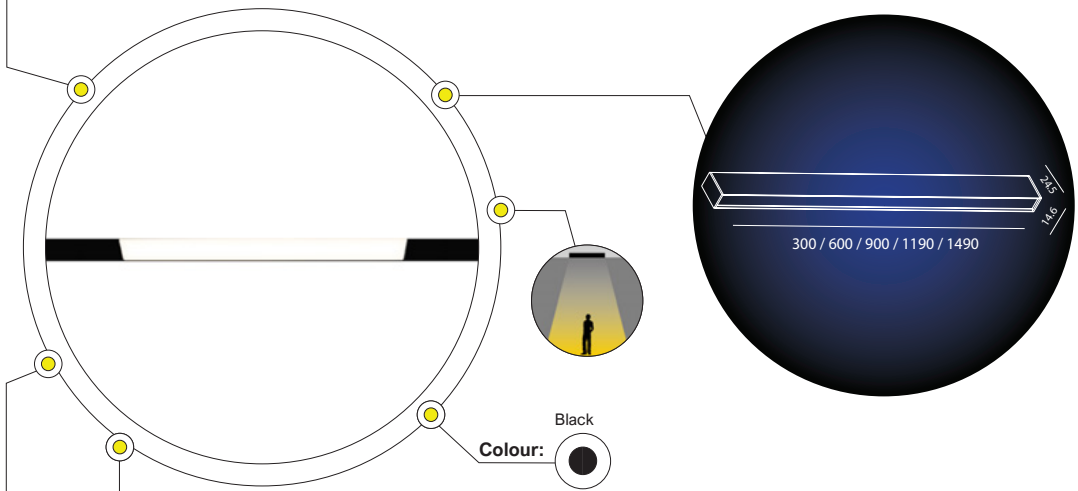

+ IP 20



LOA

3 YRS

ldt

PHYSICAL DATA

FEATURES

- Material: Aluminium
- The MOONLINE CS is a decorative floodlight, that offers a soft diffused lighting effect
- LUNA is a compact and comprehensive lighting track system with magnetically installed luminaires.
- Sharp minimalist design also provides style and elegance, suitable for any project
- Not dimmable

OPTIONS & ACCESSORIES

- The MOONLINE is available on the LUNA M, LUCA S and ULTRA Track Systems

MOUNTING

Track, Luna S

APPLICATION AREAS

Indoor, Commercial, Residential, Hospitality, Retail

TECHNICAL DATA

LF520614

LF520714

LF520814

LF520914

LF521014

	LF520614	LF520714	LF520814	LF520914	LF521014
LAMP	LED	LED	LED	LED	LED
TOTAL POWER (W)	11.3W	11.3W	11.3W	11.3W	11.3W
SYSTEM OUTPUT (LM)	456LM	456LM	456LM	456LM	456LM
CCT (K)	2700K / 3000K 3500 / 4000K	2700K / 3000K 3500 / 4000K	2700K / 3000K 3500 / 4000K	2700K / 3000K 3500 / 4000K	2700K / 3000K 3500 / 4000K
CRI (Ra)	80	80	80	80	80
BEAM ANGLE	180°	180°	180°	180°	180°
OPERATING VOLTAGE	48VDC	48VDC	48VDC	48VDC	48VDC
LENGTH	L:300mm	L:600mm	L:900mm	L:1190mm	L:1490mm
DIMENSIONS	W:14.6 x H:24.5mm	W:14.6 x H:24.5mm	W:14.6 x H:24.5mm	W:14.6 x H:24.5mm	W:14.6 x H:24.5mm

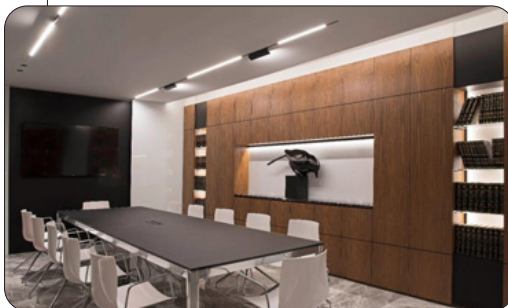

- CD / KLM
- C0 - C180
 - C90 - C270

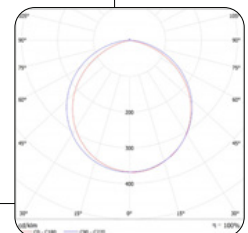

E&OE MAY OCCUR

SHINY CS ON 5

TRACK SPOT FOR LUNA S

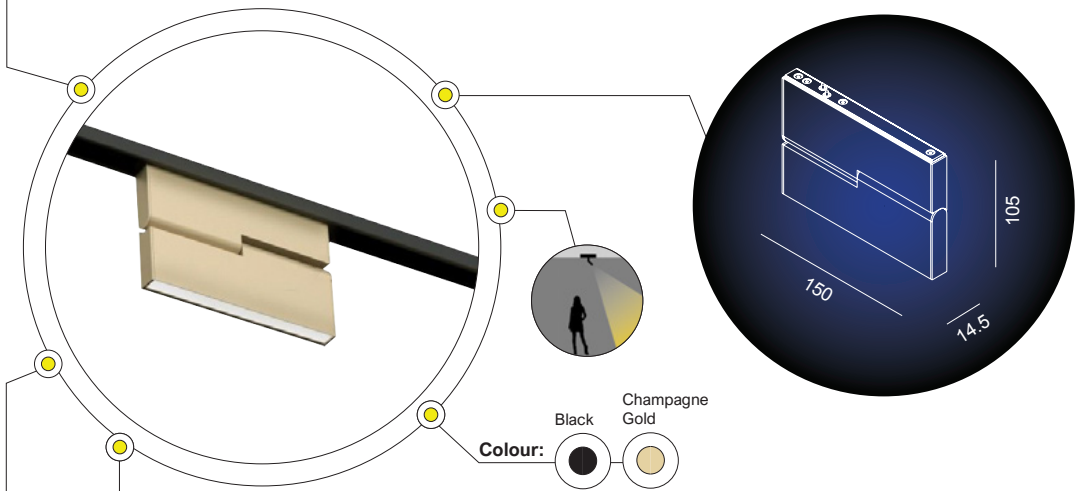

+ IP 20



LOA

3 YRS

ldt



PHYSICAL DATA

FEATURES

- Material: Aluminium
- Part of the Luna S Magnetic Track System
- The SHINY CS ON 5 can adjust with its 90° angle to accent any desired area of the space
- LUNA is a compact and comprehensive lighting track system with magnetically installed luminaires.
- Not dimmable

OPTIONS & ACCESSORIES

- Shiny CS ON 10 available: L:300 x H:105 x W:14.6mm
- The SHINY ON series is available for the LUCA M and ARMO Track Systems

MOUNTING: Track, Luna S

APPLICATION AREAS: Indoor, Commercial, Residential, Hospitality, Retail

TECHNICAL DATA

LF521114

LAMP	LED
TOTAL POWER (W)	5.2W
SYSTEM OUTPUT (LM)	206LM
CCT (K)	2700 / 3000 / 4000K
CRI (Ra)	80
BEAM ANGLE	180°
OPERATING VOLTAGE-VAC	48VDC
DIMENSIONS	L:150 x H:105 x W:14.5mm



- CD / KLM
- C0 - C180
 - C90 - C270

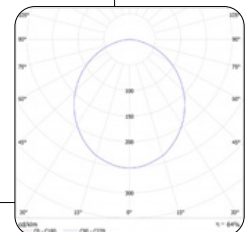

E&OE MAY OCCUR

SHINY CS ON 10

TRACK SPOT FOR LUNA S

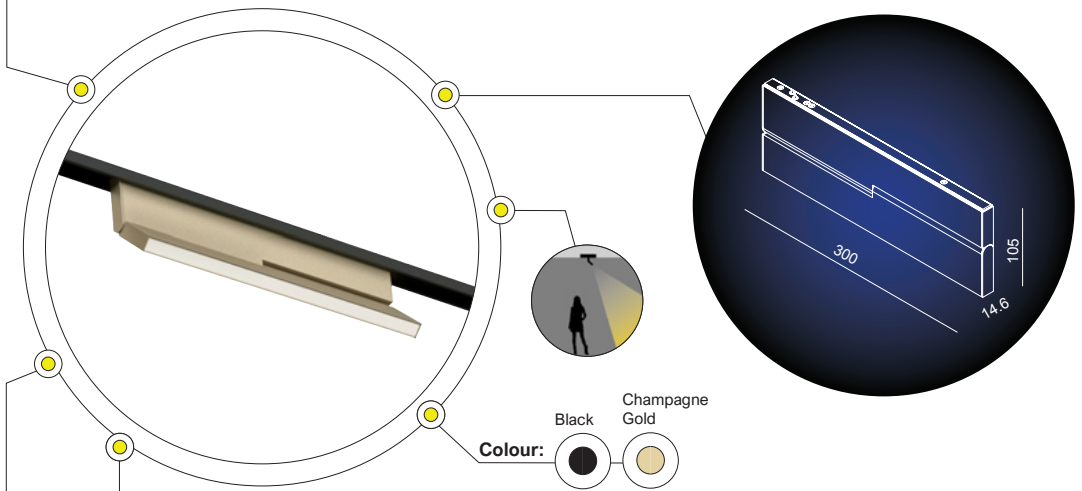

+ IP 20



LOA

3 YRS

ldt



PHYSICAL DATA

FEATURES

- Material: Aluminium
- Part of the Luna S Magnetic Track System
- The SHINY CS ON 10 can adjust with its 90° angle to accent any desired area of the space
- LUNA is a compact and comprehensive lighting track system with magnetically installed luminaires
- Not dimmable

OPTIONS & ACCESSORIES

- Shiny CS ON 5 available: L:150 x H:105 x W:14.6mm
- The SHINY ON series is available for the LUCA M and ARMO Track Systems

MOUNTING: Track, Luna S

APPLICATION AREAS

Indoor, Commercial, Residential, Hospitality, Retail

TECHNICAL DATA

LF521214

LAMP	LED
TOTAL POWER (W)	10W
SYSTEM OUTPUT (LM)	456LM
CCT (K)	2700 / 3000 / 4000K
CRI (Ra)	80
BEAM ANGLE	180°
OPERATING VOLTAGE-VAC	48VDC
DIMENSIONS	L:300 x H:105 x W:14.6mm



- CD / KLM
- C0 - C180
 - C90 - C270

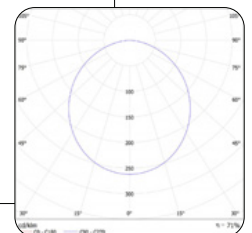

E&OE MAY OCCUR

SHINY CS ON SPOT 5

TRACK SPOT FOR LUNA S

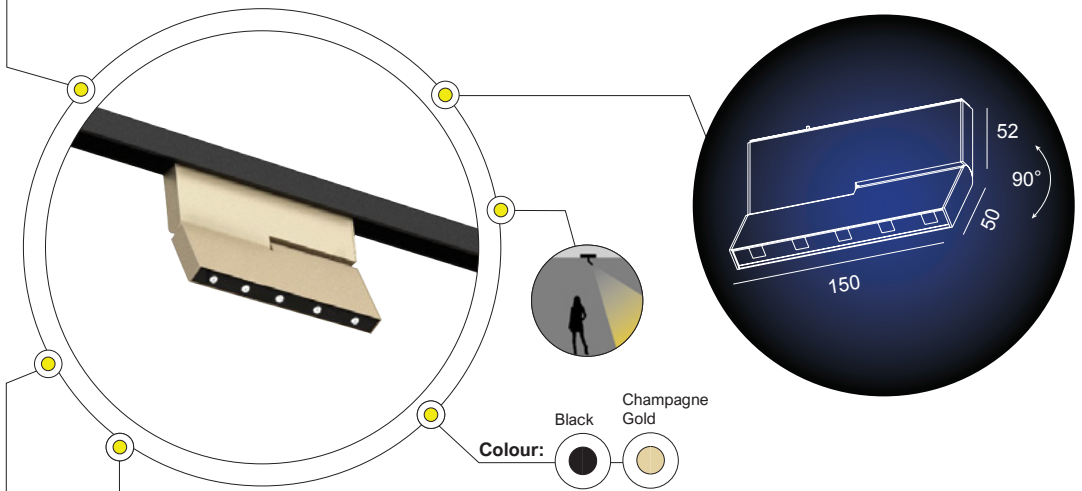

+ IP 20



LOA

3 YRS

ldt



PHYSICAL DATA

FEATURES

- Material: Aluminium
- The SHINY CS ON SPOT 5 can adjust with its 90° angle to accent any desired area of the space
- LUNA is a compact and comprehensive lighting track system with magnetically installed luminaires
- Sharp minimalist design also provides style and elegance, suitable for any project
- Not dimmable

OPTIONS & ACCESSORIES

- Shiny CS ON SPOT 10 available: L:301 x H:102 x W:14.5mm with its 180° adjustable angle

MOUNTING: Track, Luna S

APPLICATION AREAS

Indoor, Commercial, Residential, Hospitality, Retail

TECHNICAL DATA

LF520417

LAMP	LED
TOTAL POWER (W)	5.5W
SYSTEM OUTPUT (LM)	424LM
CCT (K)	2700 / 3000 / 4000K
CRI (Ra)	90
BEAM ANGLE	20°
OPERATING VOLTAGE-VAC	48VDC
WEIGHT (KG)	0.4KG
DIMENSIONS	L:150 x H:102 x W:14.5mm

- CD / KLM
- C0 - C180
- C90 - C270

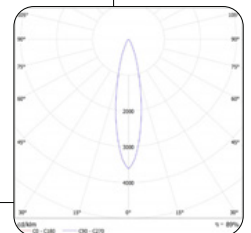

E&OE MAY OCCUR

TRACK & TRACK SPOTS - MAGNETIC TRACKS - LUNA S - TRACK SPOTS - SHINY CS ON SPOT 5

SHINY CS ON SPOT 10

TRACK SPOT FOR LUNA S

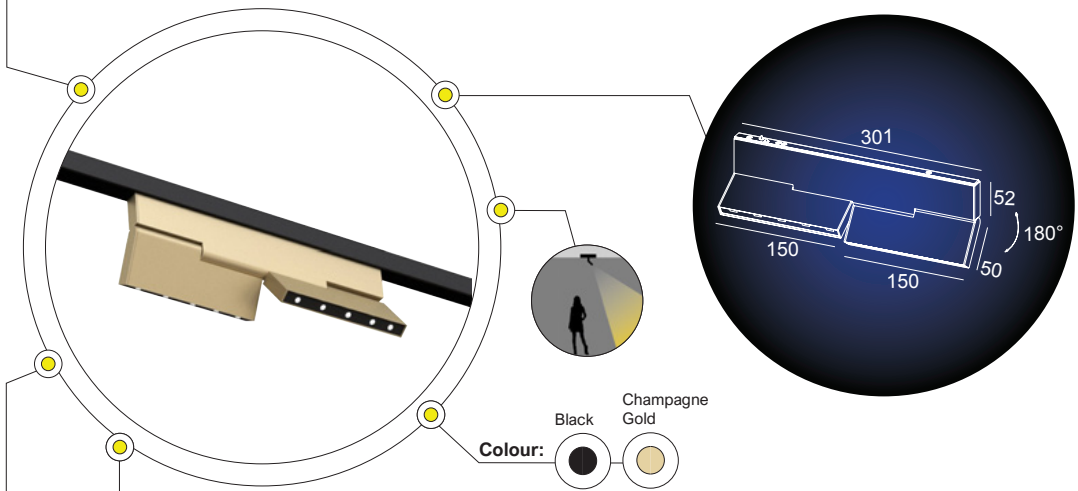

+ IP 20



LOA

3 YRS

ldt



PHYSICAL DATA

FEATURES

- Material: Aluminium
- The SHINY CS ON SPOT 10 can adjust with its 180° angle to accent any desired area of the space
- It is beautiful and practical and is suitable for both commercial and residential spaces
- LUNA is a compact and comprehensive lighting track system with magnetically installed luminaires
- Not dimmable

OPTIONS & ACCESSORIES

- Shiny CS ON SPOT 5 available: L:150 x H:102 x W:14.5mm with its 90° adjustable angle
- Available for the LUCA M and ARMO Track Systems

MOUNTING: Track, Luna S

APPLICATION AREAS

Indoor, Commercial, Residential, Hospitality, Retail

TECHNICAL DATA

LF520527

LAMP	LED
TOTAL POWER (W)	11.6W
SYSTEM OUTPUT (LM)	848LM
CCT (K)	2700 / 3000 / 4000K
CRI (Ra)	90
BEAM ANGLE	20°
OPERATING VOLTAGE-VAC	48VDC
WEIGHT (KG)	0.65KG
DIMENSIONS	L:301 x H:102 x W:14.5mm

- CD / KLM
- C0 - C180
 - C90 - C270

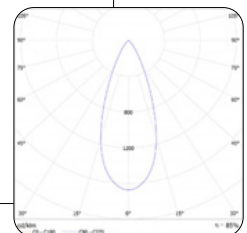

E&OE MAY OCCUR

TURN CS MINI

TRACK SPOT FOR LUNA S

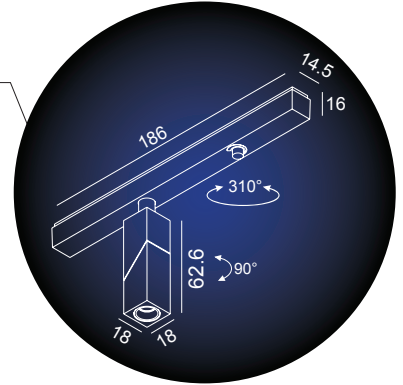
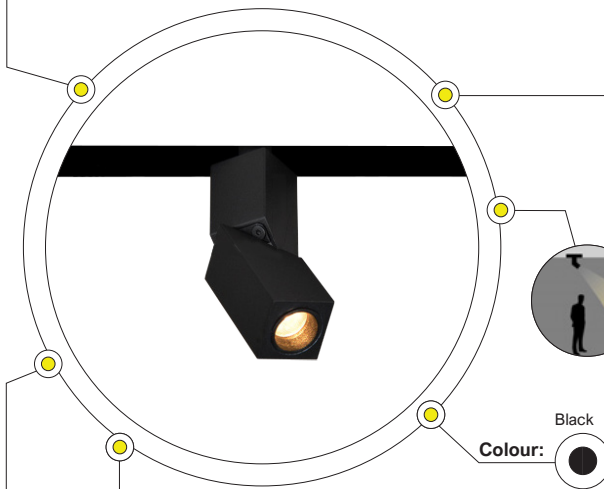

+ IP 20



LOA

3 YRS

ldt



PHYSICAL DATA

FEATURES

- Material: Aluminium
- Part of the Luna S Magnetic Track System
- Touch dim function : The dimming button is on the fitting itself!
- The luminaire can be rotated within 310° degrees and the bottom part twists to a 90° angle

- The TURN is available in various wattages, sizes, as square and cylindrical-shaped options, as surface-mounted ceiling spotlights and also as track light options for the LUNA M, and LUCA Track Systems

MOUNTING: Track, Luna S

APPLICATION AREAS

Indoor, Commercial, Residential, Hospitality, Retail

OPTIONS & ACCESSORIES

TECHNICAL DATA

LF523517

LAMP	LED
TOTAL POWER (W)	0.95W
SYSTEM OUTPUT (LM)	73LM
CCT (K)	2700 / 3000 / 4000K
CRI (Ra)	90
BEAM ANGLE	22°
OPERATING VOLTAGE-VAC	48VDC
SOURCE OUTPUT (LM)	1.2W
DIMMING RANGE	30-100%
WEIGHT (KG)	0.1KG
DIMENSIONS	L:186 x W:18 x H:62mm

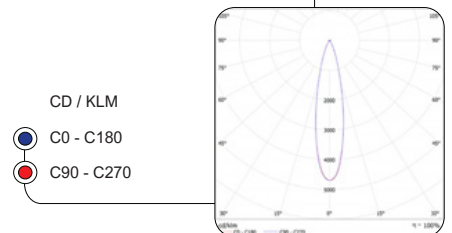
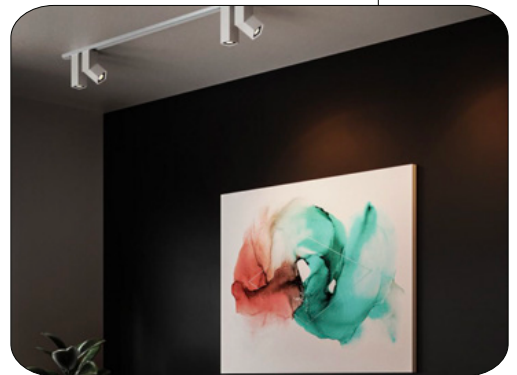

E&OE MAY OCCUR

TURN CS S

TRACK SPOT FOR LUNA S

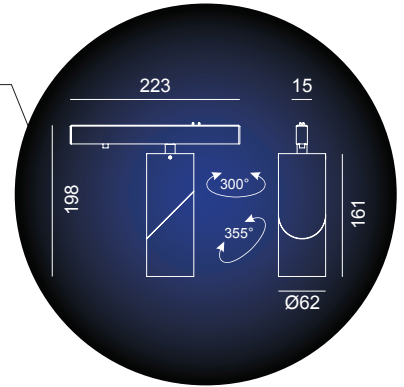
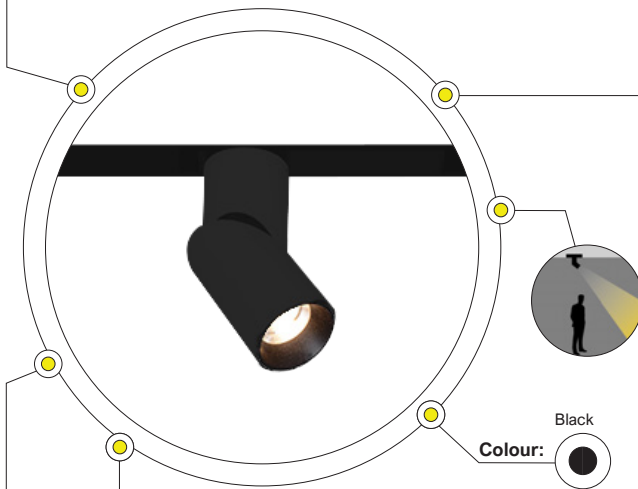

+ IP 20



LOA

3 YRS



PHYSICAL DATA

FEATURES

- Material: Aluminium
- The TURN CS S is a spotlight used with the Luna S Magnetic Track
- Touch dim function : The dimming button is on the fitting itself! The luminaire can be rotated within 300° degrees and the bottom part twists 355° degrees

- The TURN is available in various wattages, sizes, as square and cylindrical-shaped options, as surface-mounted ceiling spotlights and also as track light options for the LUNA M, and LUCA Track Systems

MOUNTING: Track, Luna S

APPLICATION AREAS: Indoor, Commercial, Residential, Hospitality, Retail

OPTIONS & ACCESSORIES

TECHNICAL DATA

LF532219ETD

LAMP	LED
TOTAL POWER (W)	7.5W
SYSTEM OUTPUT (LM)	607LM
CCT (K)	2700 / 3000 / 4000K
CRI (Ra)	90
BEAM ANGLE	28° / 38° / 48°
OPERATING VOLTAGE-VAC	48VDC
DIMMING RANGE	30-100%
WEIGHT (KG)	0.1KG
DIMENSIONS	D:φ62 x H:161 x L:223mm



E&OE MAY OCCUR

TURN CS S SQUARED

TRACK SPOT FOR LUNA S

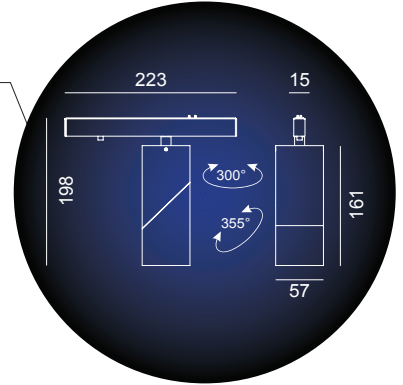
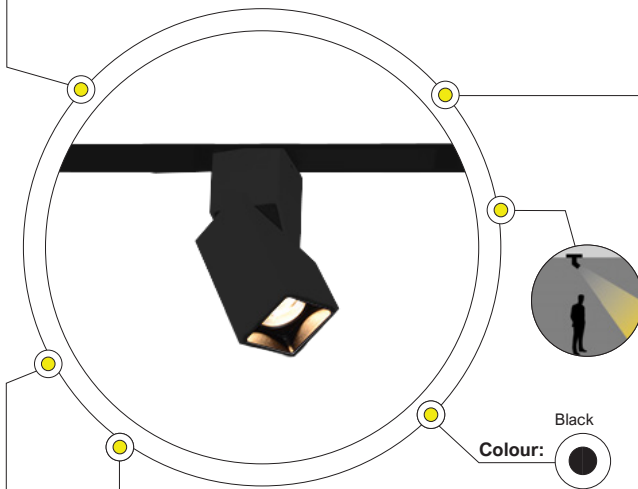

+ IP 20



LOA

3 YRS



PHYSICAL DATA

FEATURES

- Material: Aluminium
- The TURN CS S SQUARED, a spotlight, is used with the Luna S Magnetic Track
- Touch dim function : The dimming button is on the fitting itself! The luminaire can be rotated within 300° degrees and the bottom part twists 355° degrees

- The TURN is available in various wattages, sizes, as square and cylindrical-shaped options, as surface-mounted ceiling spotlights and also as track light options for the LUNA M, and LUCA Track Systems

MOUNTING: Track, Luna S

APPLICATION AREAS: Indoor, Commercial, Residential, Hospitality, Retail

OPTIONS & ACCESSORIES

TECHNICAL DATA

LF532619ETD

LAMP	LED
TOTAL POWER (W)	7.5W
SYSTEM OUTPUT (LM)	607LM
CCT (K)	2700 / 3000 / 4000K
CRI (Ra)	90
BEAM ANGLE	28° / 38° / 48°

OPERATING VOLTAGE-VAC	48VDC
DIMMING RANGE	30-100%
WEIGHT (KG)	0.1KG
DIMENSIONS	L:57 x W:57 x H:161



E&OE MAY OCCUR

LUNA S P 120 48V

TRACK PENDANT FOR LUNA S

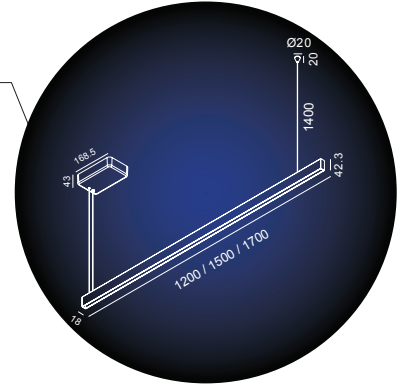
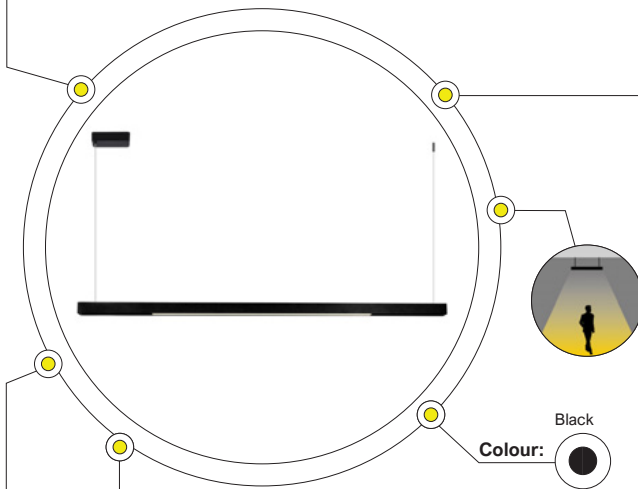

PHYSICAL DATA

FEATURES

- Material: Aluminium
- Part of the LUNA S Magnetic Track System
- LUNA is a compact and comprehensive lighting track system with magnetically installed luminaires.
- Sharp minimalist design also provides style and elegance, suitable for any project
- It is beautiful and practical and suitable for both commercial and residential spaces

OPTIONS & ACCESSORIES

- Available lengths: 1200mm, 1500mm and 1700mm

MOUNTING

Track, Luna S

APPLICATION AREAS

Indoor, Commercial, Residential, Hospitality, Retail

TECHNICAL DATA

LF002094

LF002095

LF002103

LAMP	LED	LED	LED
TOTAL POWER (W)	52.8W	52.8W	52.8W
OPERATING VOLTAGE-VAC	48VDC	48VDC	48VDC
LAMP DIMENSIONS	L:1200 x W:18 x H:42.3mm	L:1500 x W:18 x H:42.3mm	L:1700 x W:18 x H:42.3mm

➤ LED STRIP LIGHTING

PROFILES & DIFFUSERS



PROFILES & DIFFUSERS

PROFILES & DIFFUSERS

Standard



LBLEXTA4



LBLEXTA6



LBLEXTA10



LBLEXTA11

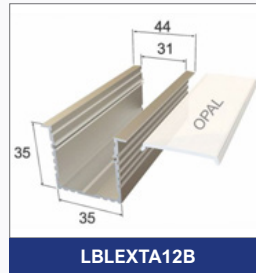

LBLEXTA12B



LBLEXTA13



LBLEXTA15



LBLEXTA48

For Joinery

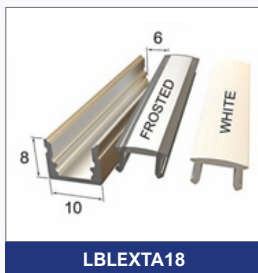

LBLEXTA18

Bendable Profile



LBLEXTA54

➤ 24V LED STRIPS

COMMERCIAL & ARCHITECTURAL

LED STRIP LIGHTING - 24V LED STRIPS



LBLFLEX4.8

24V STANDARD
NON WATERPROOF

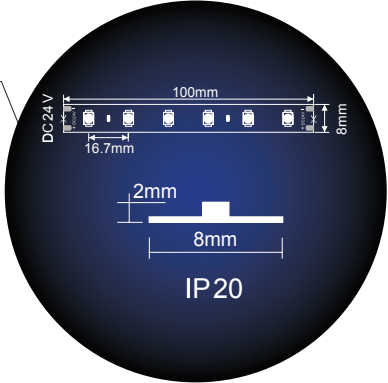
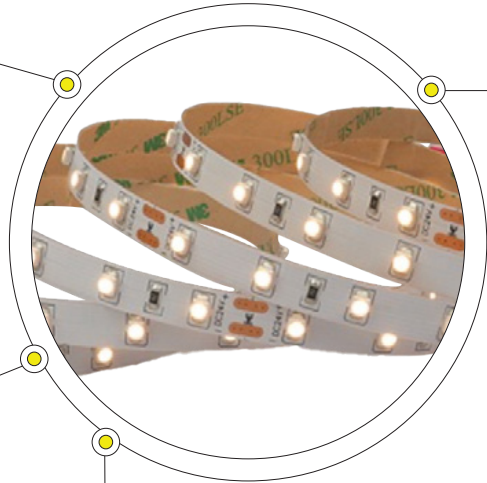

+ IP 20

LOA

5 YRS

ldt

FLX



PHYSICAL DATA

FEATURES

- Self-encapsulated design
- High thermal 3M adhesive
- Double layer FPC (2oz) for good heat dissipation
- 1-BIN delivery / 5m Reel
- Dimmable

- Offers four optional R/G/B/Y colourful lights

MOUNTING

Surface

APPLICATION AREAS

Indoor, Commercial, Residential, Retail, Hospitality

OPTIONS & ACCESSORIES

- Offers six optional 2100-6000K

TECHNICAL DATA

LBLFLEX4.8WW24V

LBLFLEX4.8CW24V

LAMP	SMD3528	SMD3528
OPERATING VOLTAGE-VAC	24V	24V
TOTAL POWER (W)	4.8W	4.8W
SYSTEM OUTPUT (LM)	375LM	397LM
EFFICACY (LM/W)	78	83
CCT (K)	3000K	4000K
CRI (Ra)	>80	>80
BEAM ANGLE	120°	120°
RATED LIFE (HRS)	50 000HRS	50 000HRS
CURRENT (MA)	0.2MA	0.2MA
OPERATING TEMP °C	-20°C TO 50°C	-20°C TO 50°C
TC CASE MAX TEMP (°C)	60°C	60°C
MAC ADAM STEP	3 STEP	3 STEP
DIMENSIONS	5000mm x 8mm x 2mm	5000mm x 8mm x 2mm
WEIGHT	0.23	0.23
CUT	100mm/cut	100mm/cut



CD / KLM

● C0 - C180

● C90 - C270

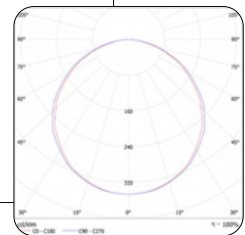

E&OE MAY OCCUR

LBLFLEX9.6

24V STANDARD
NON WATERPROOF

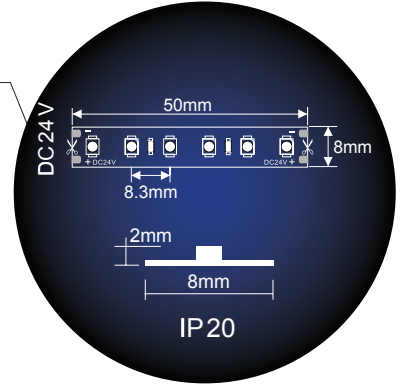

PHYSICAL DATA

FEATURES

- Self encapsulated design
- High quality PCB, high thermal 3M adhesive
- Double layer FPC (2oz) for good heat dissipation
- 1-Bin delivery
- Dimmable

- White lights and R/G/B/Y colourful lights optional

MOUNTING

Surface

APPLICATION AREAS

Indoor, Commercial, Residential, Retail, Hospitality

OPTIONS & ACCESSORIES

- Offers optional 1800-10000K

+ IP 20

LOA

5 YRS

ldt

FLX



TECHNICAL DATA

LBLFLEX9.6WW24

LBLFLEX9.6CW24V

LAMP	SMD3528	SMD3528
OPERATING VOLTAGE-VAC	24V	24V
TOTAL POWER (W)	9.6W	9.6W
SYSTEM OUTPUT (LM)	825LM	918LM
EFFICACY (LM/W)	86	95
CCT (K)	3000K	4000K
CRI (Ra)	>80	>80
BEAM ANGLE	120°	120°
RATED LIFE (HRS)	50 000HRS	50 000HRS
CURRENT (MA)	0.4MA	0.4MA
OPERATING TEMP °C	-20°C TO 50°C	-20°C TO 50°C
TC CASE MAX TEMP (°C)	60°C	60°C
MAC ADAM STEP	3 STEP	3 STEP
DIMENSIONS	5000mm x 8mm x 2mm	5000mm x 8mm x 2mm
WEIGHT	0.25	0.25
CUT	50mm/cut	50mm/cut



CD / KLM

● C0 - C180

● C90 - C270

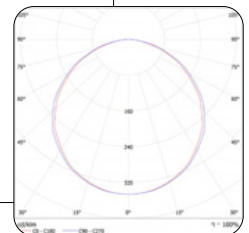

E&OE MAY OCCUR

LBLFLEX14.4

24V STANDARD
NON WATERPROOF

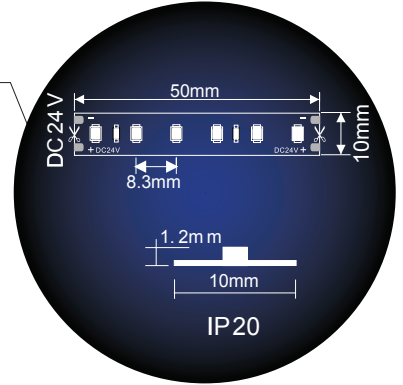

+ IP 20

LOA

5 YRS

ldt

FLX



PHYSICAL DATA

FEATURES

- Self-encapsulated design
- High-quality PCB, high-thermal 3M adhesive
- Double layer FPC (2oz) for good heat dissipation
- 1-BIN delivery / 5m Reel
- Dimmable

- Offers four optional R/G/B/Y colourful lights optional

MOUNTING

Surface

APPLICATION AREAS

Indoor, Commercial, Residential, Retail, Hospitality

OPTIONS & ACCESSORIES

- Offers six optional 2100-6000K

TECHNICAL DATA

LBLFLEX14.4WW24

LBLFLEX14.4CW24

LAMP	SMD2835	SMD2835
OPERATING VOLTAGE-VAC	24V	24V
TOTAL POWER (W)	14.4W	14.4W
SYSTEM OUTPUT (LM)	2154LM	2947LM
EFFICACY (LM/W)	90	123
CCT (K)	3000K	4000K
CRI (Ra)	>80	>80
BEAM ANGLE	120°	120°
RATED LIFE (HRS)	50 000HRS	50 000HRS
CURRENT (MA)	0.6MA	0.6MA
OPERATING TEMP °C	-20°C TO 50°C	-20°C TO 50°C
TC CASE MAX TEMP (°C)	60°C	60°C
MAC ADAM STEP	3 STEP	3 STEP
DIMENSIONS	5000mm x 10mm x 1.2mm	5000mm x 10mm x 1.2mm
WEIGHT	0.25	0.25
CUT	50mm/cut	50mm/cut

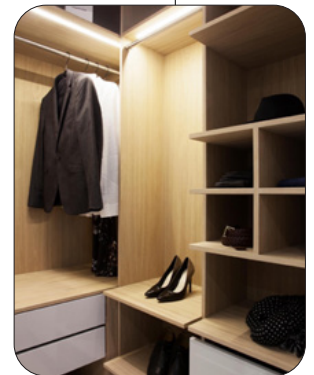

CD / KLM

● C0 - C180

● C90 - C270

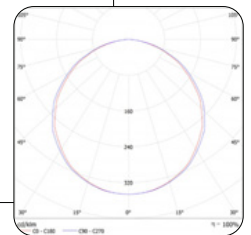

E&OE MAY OCCUR

LBLFLEXW4.8

24V STANDARD
WATERPROOF

LED STRIP LIGHTING - 24V STRIPS - STANDARD - WATERPROOF - LBLFLEXW4.8

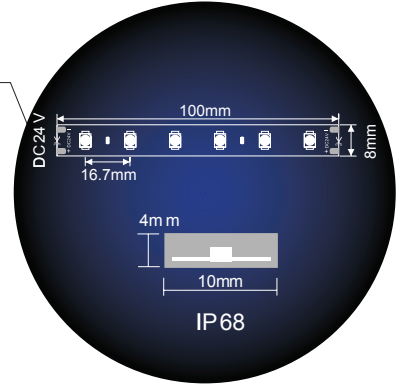

+ IP 68

LOA

3 YRS

ldt

FLX



PHYSICAL DATA

FEATURES

- Self-encapsulated design
- High-quality PCB, high-thermal 3M adhesive
- Double layer FPC (2oz) for good heat dissipation
- 1-BIN delivery / 5m Reel
- Dimmable

- Offers white lights and R/G/B/Y colourful lights

MOUNTING

Surface

APPLICATION AREAS

Indoor, Commercial, Residential, Retail, Hospitality

OPTIONS & ACCESSORIES

- Offers optional 1800 -10 000K

TECHNICAL DATA

LBLFLEXW4.8WW24

LBLFLEXW4.8CW24

LAMP	SMD3528	SMD3528
OPERATING VOLTAGE-VAC	24V	24V
TOTAL POWER (W)	4.8W	4.8W
SYSTEM OUTPUT (LM)	454LM	504LM
EFFICACY (LM/W)	95	105
CCT (K)	3000K	4000K
CRI (Ra)	>80	>80
BEAM ANGLE	120°	120°
RATED LIFE (HRS)	30 000HRS	30 000HRS
CURRENT (MA)	0.2MA	0.2MA
OPERATING TEMP °C	-20°C TO 50°C	-20°C TO 50°C
TC CASE MAX TEMP (°C)	60°C	60°C
MAC ADAM STEP	3 STEP	3 STEP
DIMENSIONS	5000mm x 10mm x 4mm	5000mm x 10mm x 4mm
WEIGHT	0.45	0.45
CUT	100mm/cut	100mm/cut



CD / KLM

● C0 - C180

● C90 - C270

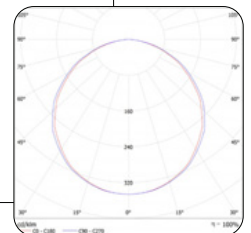

E&OE MAY OCCUR

LBLFLEXW9.6

24V STANDARD
WATERPROOF

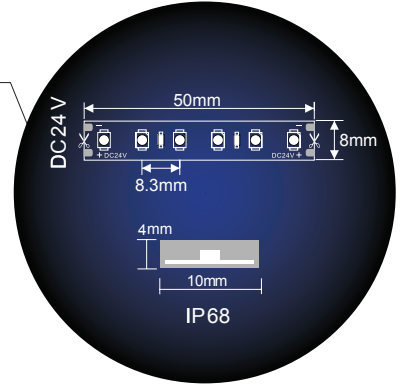

+ IP 68

LOA

3 YRS

ldt

FLX



PHYSICAL DATA

FEATURES

- Self-encapsulated design
- High-quality PCB, high-thermal 3M adhesive
- Double layer FPC (2oz) for good heat dissipation
- 1-BIN delivery / 5m Reel
- Dimmable

- White lights and R/G/B/Y colourful lights optional

MOUNTING

Surface

APPLICATION AREAS

Indoor, Commercial, Residential, Retail, Hospitality

OPTIONS & ACCESSORIES

- Offers optional 1800-10000K

TECHNICAL DATA

LBLFLEXW9.6WW24

LBLFLEXW9.6CW24

LAMP	SMD3528	SMD3528
OPERATING VOLTAGE-VAC	24V	24V
TOTAL POWER (W)	9.6W	9.6W
SYSTEM OUTPUT (LM)	718LM	779LM
EFFICACY (LM/W)	75	81
CCT (K)	3000K	4000K
CRI (Ra)	>80	>80
BEAM ANGLE	120°	120°
RATED LIFE (HRS)	30 000HRS	30 000HRS
CURRENT (MA)	0.4MA	0.4MA
OPERATING TEMP °C	-20°C TO 50°C	-20°C TO 50°C
TC CASE MAX TEMP (°C)	60°C	60°C
MAC ADAM STEP	3 STEP	3 STEP
DIMENSIONS	5000mm x 10mm x 4mm	5000mm x 10mm x 4mm
WEIGHT	0.45	0.45
CUT	50mm/cut	50mm/cut

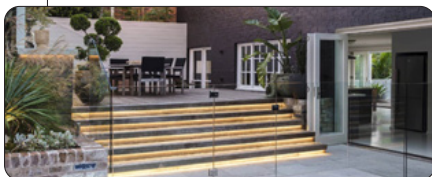
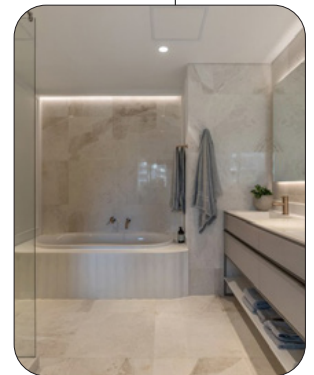

CD / KLM

● C0 - C180

● C90 - C270

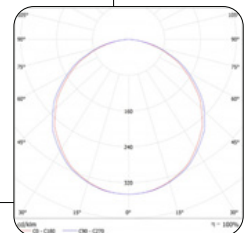

E&OE MAY OCCUR

LBLFLEXW14.4

24V STANDARD
WATERPROOF

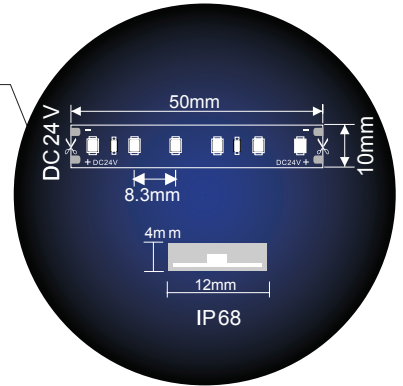

PHYSICAL DATA

+ IP 68

LOA

3 YRS

ldt

FLX



FEATURES

- Self-encapsulated design
- High-quality PCB, high-thermal 3M adhesive
- Double layer FPC (2oz) for good heat dissipation
- 1-BIN delivery / 5m Reel
- Dimmable

- Offers four optional R/G/B/Y colourful lights optional

MOUNTING

Surface

APPLICATION AREAS

Indoor, Commercial, Residential, Retail, Hospitality

OPTIONS & ACCESSORIES

- Offers six optional 2100-6000K

TECHNICAL DATA

LBLFLEXW14.4WW24

LBLFLEXW14.4CW24

LAMP	SMD2835	SMD2835
OPERATING VOLTAGE-VAC	24V	24V
TOTAL POWER (W)	14.4W	14.4W
SYSTEM OUTPUT (LM)	2135LM	2947LM
EFFICACY (LM/W)	90	90
CCT (K)	3000K	4000K
CRI (Ra)	>80	>80
BEAM ANGLE	120°	120°
RATED LIFE (HRS)	30 000HRS	30 000HRS
CURRENT (MA)	1.2MA	1.2MA
OPERATING TEMP °C	-20°C TO 50°C	-20°C TO 50°C
TC CASE MAX TEMP (°C)	60°C	60°C
MAC ADAM STEP	3 STEP	3 STEP
DIMENSIONS	5000mm x 12mm x 4mm	5000mm x 12mm x 4mm
WEIGHT	0.45	0.45
CUT	50mm/cut	50mm/cut

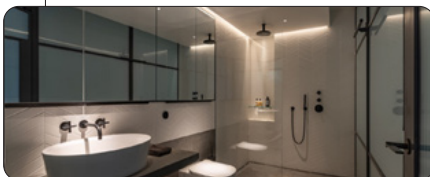
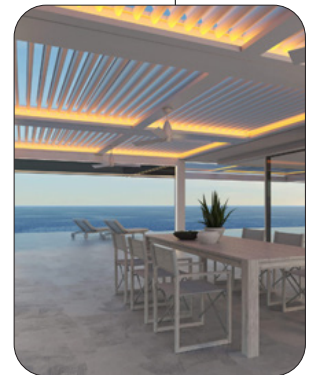

CD / KLM

● C0 - C180

● C90 - C270

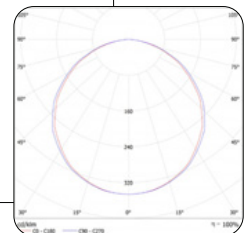

E&OE MAY OCCUR

LBLFLEX5

**24V SPECIAL STRIPS
NON WATERPROOF**

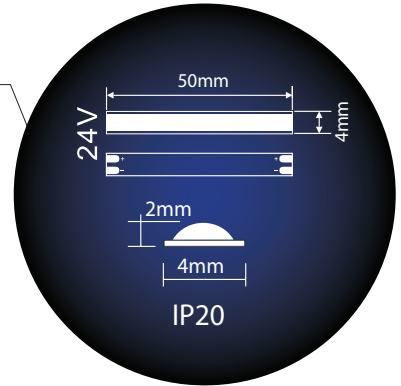
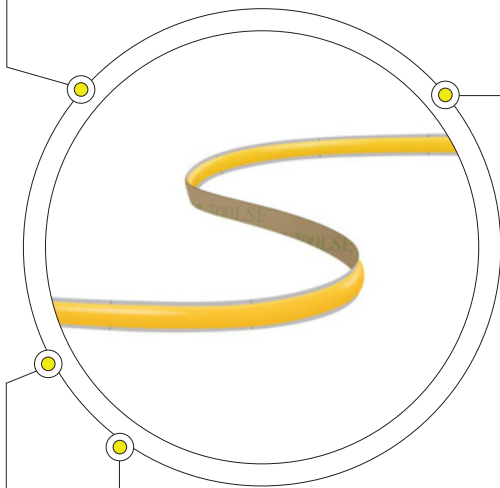

+IP
20

LOA

✓
5 YRS

ldt

FLX



PHYSICAL DATA

FEATURES

- Light beam angle up to 180°
- Chips on narrow strip
- High quality PCB, high thermal 3M adhesive
- No dots shown through diffusers
- The density of chips is 480 chips per meter

- Various mono-colours available as well as RGB, RGBW and Tunable white COB strips for selection
- The available widths of PCB for selection: 4mm, 8mm, and 10mm

MOUNTING: Surface

OPTIONS & ACCESSORIES

- CCT (K) available for selection: 2700K, 3000K, 4000K and 6500K

APPLICATION AREAS: Indoor, Commercial, Residential, Retail, Hospitality

TECHNICAL DATA

LBLFLEX5WW24V

LAMP	LED COB
OPERATING VOLTAGE-VAC	24V
TOTAL POWER (W)	5W
SYSTEM OUTPUT (LM)	512LM @ 3000K
EFFICACY (LM/W)	93
CCT (K)	3000K
CRI (Ra)	90
BEAM ANGLE	180°
CURRENT (A/m)	0.21A
OPERATING TEMP °C	-20°C TO 50°C
MAC ADAM STEP	3 STEP
DIMENSIONS	L:5000 x W:4 x H:2mm
CUT	50mm/cut



- CD / KLM
- C0 - C180
- C90 - C270

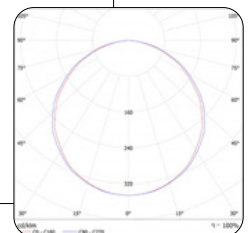

E&OE MAY OCCUR

LBLFLEX10

24V SPECIAL STRIPS
NON WATERPROOF

LED STRIP LIGHTING - 24V STRIPS - SPECIAL - NON-WATERPROOF - LBLFLEX10

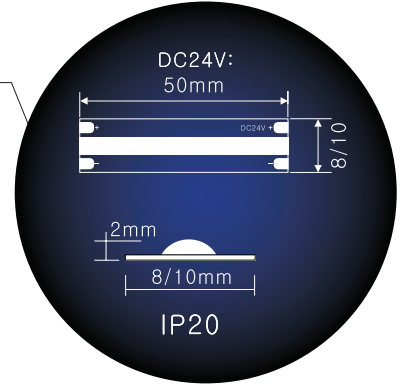
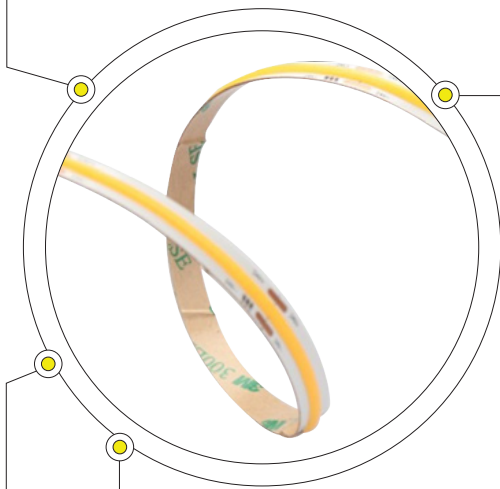

+IP
20

LOA

5 YRS

ldt

FLX



PHYSICAL DATA

FEATURES

- Light beam angle up to 180°
- Self encapsulated design
- Chips on broad strip
- High quality PCB, high thermal 3M adhesive
- No dots shown through diffusers

MOUNTING

Surface

APPLICATION AREAS

Indoor, Commercial, Residential, Retail, Hospitality

OPTIONS & ACCESSORIES

- Offers optional 2700-6000K

TECHNICAL DATA

LBLFLEX10WW24V

LBLFLEX10CW24V

LAMP	COB LED	COB LED
OPERATING VOLTAGE-VAC	24V	24V
TOTAL POWER (W)	10W	10W
SYSTEM OUTPUT (LM)	880LM	989LM
EFFICACY (LM/W)	88	99
CCT (K)	3000K	4000K
CRI (Ra)	>80	>80
BEAM ANGLE	180°	180°
RATED LIFE (HRS)	50 000HRS	50 000HRS
CURRENT (MA)	0.42MA	0.42MA
OPERATING TEMP °C	-20°C TO 50°C	-20°C TO 50°C
TC CASE MAX TEMP (°C)	60°C	60°C
MAC ADAM STEP	3 STEP	3 STEP
DIMENSIONS	5000mm x 10mm x 2mm	5000mm x 10mm x 2mm
WEIGHT	0.25	0.25
CUT	50mm/cut	50mm/cut

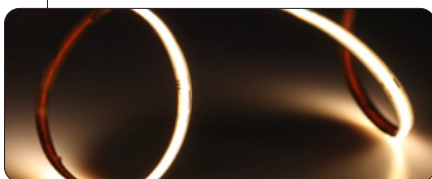

CD / KLM

● C0 - C180

● C90 - C270

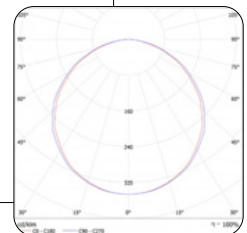

E&OE MAY OCCUR

LBLFLEX100

24V SPECIAL STRIPS
NON WATERPROOF

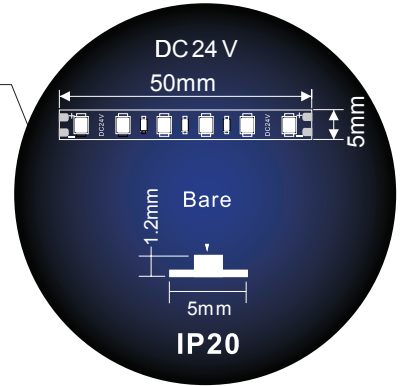
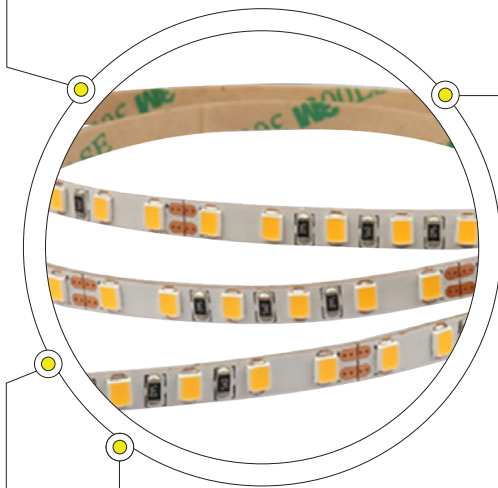

+ IP 20

LOA

5 YRS

ldt

FLX



PHYSICAL DATA

FEATURES

- Self-encapsulated design
- High quality PCB, high thermal 3M adhesive
- 1-BIN delivery / 5m Reel
- Dimmable
- Very narrow for minimalistic design
- Special strip for A18 profile

- Offers optional 2100 - 6000K
- White lights and R/G/B/Y and others colorful lights for option

MOUNTING

Surface

APPLICATION AREAS

Indoor, Commercial, Residential, Retail, Hospitality

OPTIONS & ACCESSORIES

TECHNICAL DATA

LBLFLEX100WW

LBLFLEX100CW

LAMP	SMD2835	SMD2835
OPERATING VOLTAGE-VAC	24V	24V
TOTAL POWER (W)	6.7W	6.7W
SYSTEM OUTPUT (LM)	594LM	594LM
EFFICACY (LM/W)	88	88
CCT (K)	3000K	4000K
CRI (Ra)	>80	>80
BEAM ANGLE	120°	120°
RATED LIFE (HRS)	50 000HRS	50 000HRS
CURRENT (MA)	0.56MA	0.56MA
OPERATING TEMP °C	-20°C TO 50°C	-20°C TO 50°C
TC CASE MAX TEMP (°C)	60°C	60°C
MAC ADAM STEP	3 STEP	3 STEP
DIMENSIONS	5000mm x 5mm x 1.2mm	5000mm x 5mm x 1.2mm
WEIGHT	0.25	0.25
CUT	50mm/cut	50mm/cut



CD / KLM

● C0 - C180

● C90 - C270

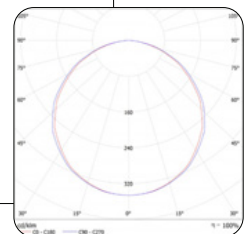

E&OE MAY OCCUR

LBLFLEX18DTW224

24V SPECIAL STRIPS
NON WATERPROOF

LED STRIP LIGHTING - 24V STRIPS - SPECIAL - NON-WATERPROOF - LBLFLEX18DTW224

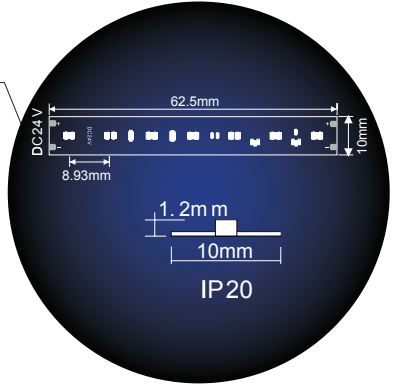
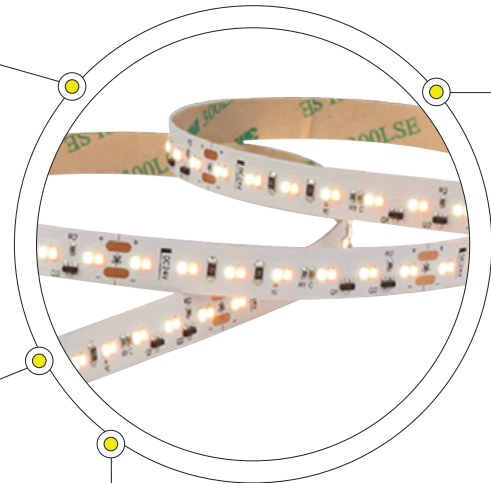

- + IP 20
- LOA
- 5 YRS
- ldt
- FLX
-

PHYSICAL DATA

FEATURES

- Dim to Warm White LED strip
- Dim by TRIAC, 0/1 - 10V, DALI and PWM constant voltage dimmable driver
- High quality PCB, high thermal 3M adhesive
- 1-Bin delivery

MOUNTING

Surface

APPLICATION AREAS

Indoor, Commercial, Residential, Retail, Hospitality

OPTIONS & ACCESSORIES

- Other CCT available for selection

TECHNICAL DATA

LBLFLEX18DTW224

LAMP	SMD2216
OPERATING VOLTAGE-VAC	24V
TOTAL POWER (W)	18W (full brightness)
SYSTEM OUTPUT (LM)	1529LM @ 3000K
EFFICACY (LM/W)	85
CCT (K)	1800-3000K
CRI (Ra)	>80
BEAM ANGLE	120°
RATED LIFE (HRS)	50 000HRS
CURRENT (MA)	0.75MA
OPERATING TEMP °C	0°C TO 50°C
TC CASE MAX TEMP (°C)	60°C
MAC ADAM STEP	3 STEP
DIMENSIONS	5000mm x 10mm x 1.2mm
WEIGHT	0.25
CUT	62.5mm/cut



Project Ernie Els Winery / Design Rumour Has It / Photography Charles Russell



Project Ernie Els Winery

- CD / KLM
- C0 - C180
- C90 - C270

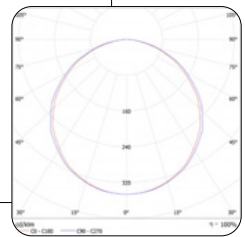

E&OE MAY OCCUR

LBLFLEX18WDTW224

24V SPECIAL STRIPS
WATERPROOF

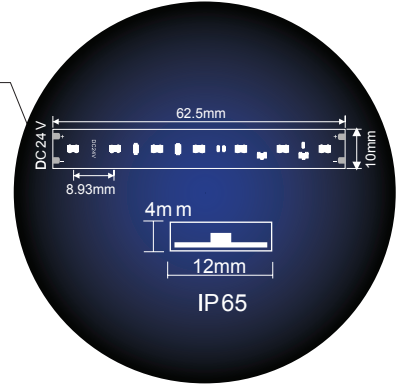

+ IP 65

LOA

3 YRS

ldt

FLX



PHYSICAL DATA

FEATURES

- Dim to Warm White LED strip
- Dim by TRIAC, 0/1 - 10V, DALI and PWM constant voltage dimmable driver
- High quality PCB, high thermal 3M adhesive
- 1-Bin delivery

MOUNTING

Surface

APPLICATION AREAS

Indoor, Commercial, Residential, Retail, Hospitality

OPTIONS & ACCESSORIES

- Other CCT available for selection

TECHNICAL DATA

LBLFLEX18WDTW224

LAMP	SMD2216
OPERATING VOLTAGE-VAC	24V
TOTAL POWER (W)	18W (full brightness)
SYSTEM OUTPUT (LM)	1529LM @ 3000K
EFFICACY (LM/W)	85
CCT (K)	1800-3000K
CRI (Ra)	>80
BEAM ANGLE	120°
RATED LIFE (HRS)	50 000HRS
CURRENT (MA)	0.75MA
OPERATING TEMP °C	0°C TO 50°C
TC CASE MAX TEMP (°C)	60°C
MAC ADAM STEP	3 STEP
DIMENSIONS	5000mm x 12mm x 4mm
WEIGHT	0.25
CUT	62.5mm/cut

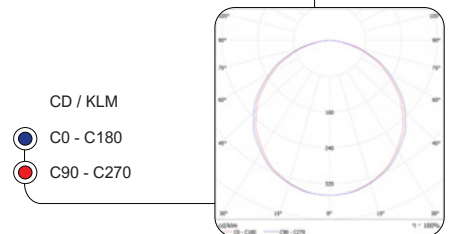
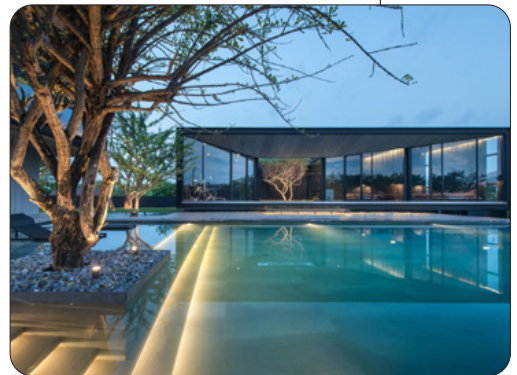

E&OE MAY OCCUR

LBLFLEX14.4RGB

24V SPECIAL STRIPS
NON - WATERPROOF

LED STRIP LIGHTING - 24V STRIPS - SPECIAL - NON-WATERPROOF - LBLFLEX14.4RGB

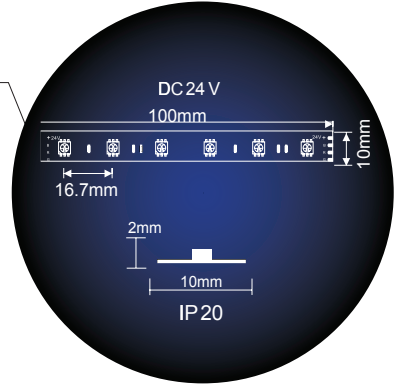
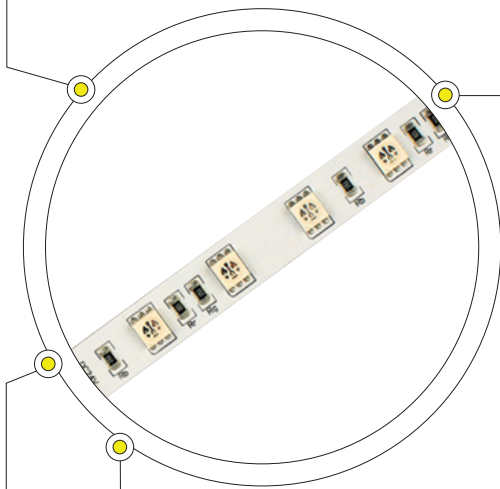

+ IP 20

LOA

5 YRS

ldt

FLX



PHYSICAL DATA

FEATURES

- RGB colourful strip
- 5050 LED with broader luminous surface
- Self-encapsulated design
- High quality PCB, high thermal 3M adhesive
- Widely adaptable to all types of controllers
- Double layer FPC(2oz) for good heat dissipation

MOUNTING

Surface

APPLICATION AREAS

Indoor, Commercial, Residential, Retail, Hospitality

TECHNICAL DATA

LBLFLEX14.4RGB

LAMP	SMD5050
OPERATING VOLTAGE-VAC	24V
TOTAL POWER (W)	14.4W
SYSTEM OUTPUT (LM)	620LM
EFFICACY (LM/W)	43
CCT (K)	39015.80K (All colours RGB @ 100%)
CRI (Ra)	57
BEAM ANGLE	120°
RATED LIFE (HRS)	50 000HRS
CURRENT (MA)	0.6MA
OPERATING TEMP°C	-20°C TO 50°C
TC CASE MAX TEMP (°C)	60°C
MAC ADAM STEP	6 STEP
DIMENSIONS	5000mm x 10mm x 2mm
WEIGHT	0.35
CUT	100mm/cut

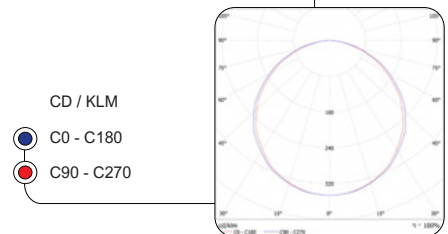

E&OE MAY OCCUR

LBLFLEXW14.4RGB

24V SPECIAL STRIPS
WATERPROOF

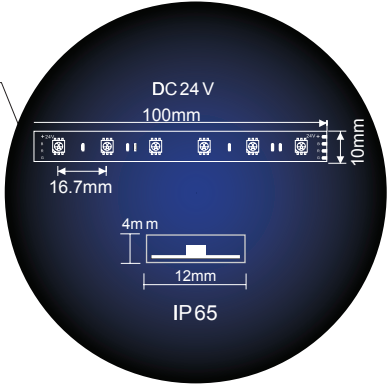

+IP 68

LOA

3 YRS

ldt

FLX



PHYSICAL DATA

FEATURES

- RGB colourful strip
- 5050 LED with broader luminous surface
- Self-encapsulated design
- High quality PCB, high thermal 3M adhesive
- Widely adaptable to all types of controllers
- Double layer FPC(2oz) for good heat dissipation

MOUNTING

Surface

APPLICATION AREAS

Outdoor, Commercial, Residential, Retail, Hospitality

TECHNICAL DATA

LBLFLEXW14.4RGB

LAMP	SMD5050
OPERATING VOLTAGE-VAC	24V
TOTAL POWER (W)	14.4W
SYSTEM OUTPUT (LM)	620LM
EFFICACY (LM/W)	43
CCT (K)	42300K (All colours RGB @ 100%)
CRI (Ra)	50
BEAM ANGLE	120°
RATED LIFE (HRS)	50 000HRS
CURRENT (MA)	0,6MA
OPERATING TEMP°C	-20°C TO 50°C
TC CASE MAX TEMP (°C)	60°C
MAC ADAM STEP	3 STEP
DIMENSIONS	5000mm x 12mm x 4mm
WEIGHT	0.35
CUT	100mm/cut

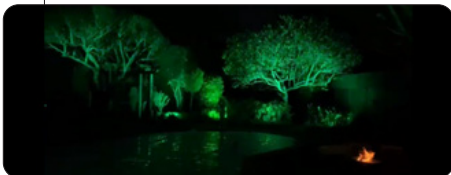

- CD / KLM
- C0 - C180
 - C90 - C270

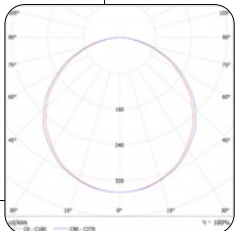

E&OE MAY OCCUR

LED STRIP LIGHTING - 24V STRIPS - SPECIAL - WATERPROOF - LBLFLEXW14.4RGB

LBLNEON6

24V SPECIAL STRIPS
WATERPROOF

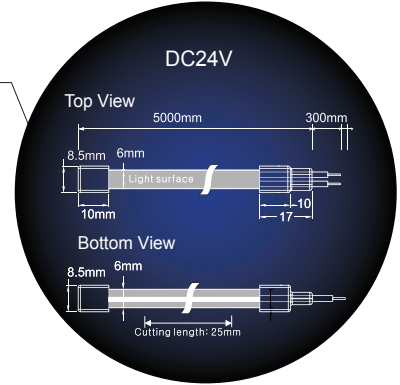
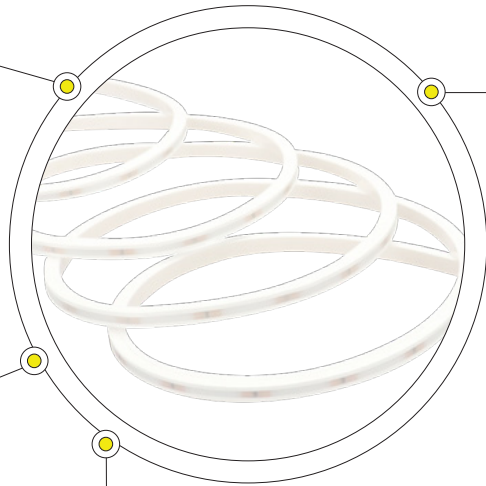

LED STRIP LIGHTING - 24V STRIPS - SPECIAL - WATERPROOF - LBLNEON6

- + IP 67
- LOA
- 3 YRS
- ldt
- FLX
-

PHYSICAL DATA

FEATURES

- Flat luminous surface series
- Top Bend - Vertical bend only!
- Minimum bending diameter is 200mm
- UV protected, solvent and saltwater resistant
- 1-BIN delivery / 5m Reel (max length) with one-end power

OPTIONS & ACCESSORIES

- Other CCT (K) available
- Mounting clips, standard end-caps, scissors with angular

scale, 2-pin cables and 2-pin connectors (single colour) accessories available for selection

- The NEON FLEX Range includes: Side Bend, Top Bend, 360° Neon, 3D Neon, PU Neon and RGB options available for selection

MOUNTING: Surface

APPLICATION AREAS

Indoor, Commercial, Residential, Retail, Hospitality

TECHNICAL DATA

LBLNEON6

LAMP	SILICONE NEON
OPERATING VOLTAGE-VAC	24V
TOTAL POWER (W)	6W/m
SYSTEM OUTPUT (LM)	348LM
EFFICACY (LM/W)	58 @ 3000K
CCT (K)	3000 / 3500 / 4000K
CRI (Ra)	>90
BEAM ANGLE	120°
RATED LIFE (HRS)	50 000HRS
OPERATING TEMP°C	-20°C TO 45°C
DIMENSIONS	W:6mm x H:6mm
MIN CUT LENGTH	25mm

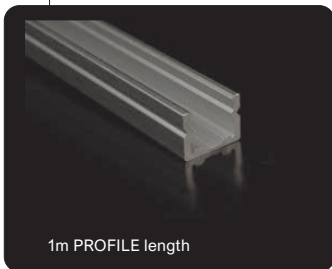
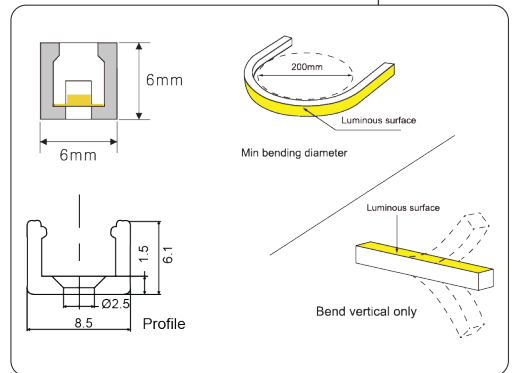

- CD / KLM
- C0 - C180
 - C90 - C270

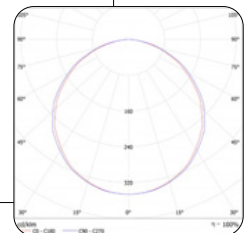

E&OE MAY OCCUR

LBLNEON9.6

24V SPECIAL STRIPS
WATERPROOF

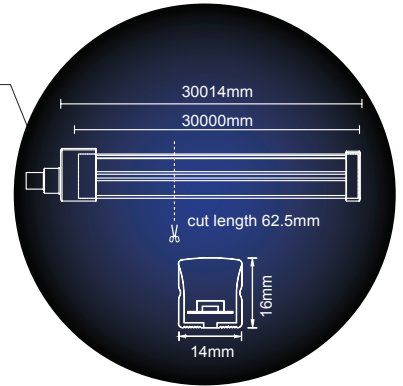
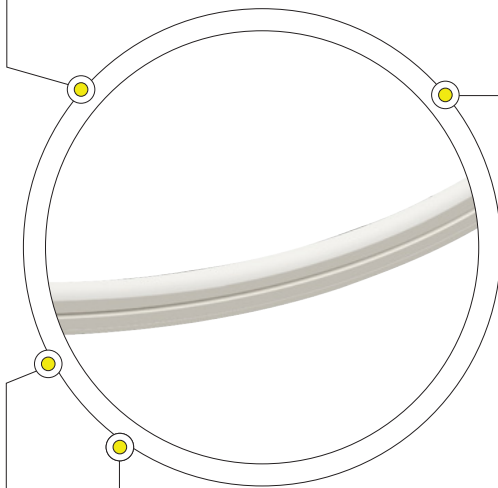

+ IP 68

LOA

3 YRS

ldt

FLX



PHYSICAL DATA

FEATURES

- Material: High-strength silicone body with super tensile resistance
- The Neon Flex is 3D bendable, it can be bendable both vertically and horizontally
- Single color, 30m long run length with single feed that is driven by one power supply with the same brightness end to end
- PCB designed in parallel with function of skipping

broken cuttable unit

- Warranty: 5 years indoors, 3 years outdoors
- Flame resistant, Solvent resistant, Saltwater resistant, UV resistant

MOUNTING: as per application requirements

APPLICATION AREAS

Indoor, Commercial, Residential, Retail, Hospitality

TECHNICAL DATA

LBLNEON9.6

LAMP	LED
TOTAL POWER (W)	9.6W/m
SYSTEM OUTPUT (LM)	448 / 483 / 493 / 504 / 476 / 515LM/w
EFFICACY (LM/W)	47 / 50 / 51 / 53 / 50 / 54
CCT (K)	2700 / 3000 / 3500 / 4000 / 5000 / 6000K
CRI (Ra)	>80
BEAM ANGLE	112°
OPERATING VOLTAGE-VAC	24V DC
OPERATING TEMP °C	-20°C to 60°C
STORAGE TEMP °C	-20°C to 70°C
IMPACT RATING (IK)	IK08
DIMENSIONS	L:14 x H:16mm
MIN CUT LENGTH	62.5mm

Bending diameter:

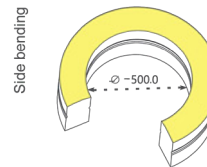
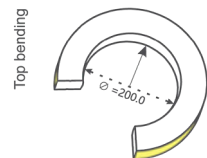

E&OE MAY OCCUR

LBLNEON16 - SINGLE

24V SPECIAL STRIPS
WATERPROOF

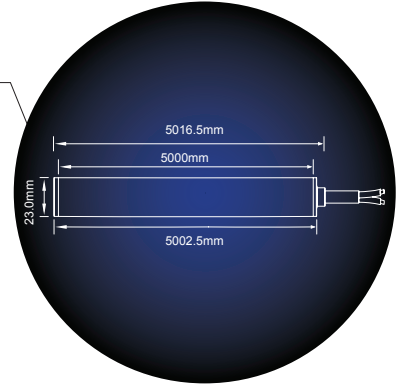
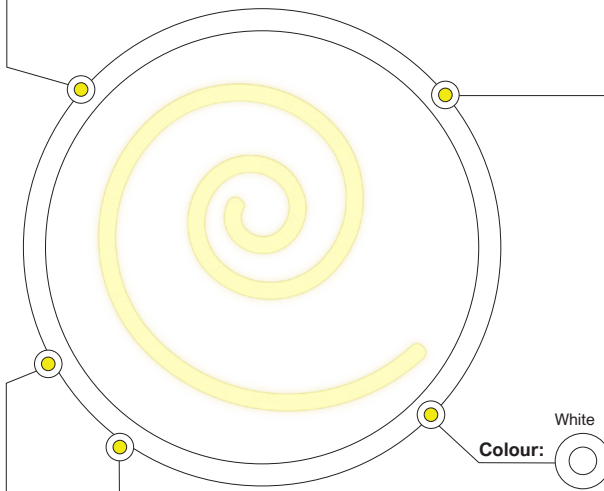

+IP 65

LOA

3 YRS

ldt

FLX



PHYSICAL DATA

FEATURES

- Material: Silicone extrusion
- Superior design with exquisite craftsmanship ensure stable and reliable performance
- Flexibility: 360 bending, minimum bend diameter 120mm
- Saltwater resistant, UV resistant, Temporary immersion protection, Solvent resistant, Flame resistant
- Dimmable, 5m Reel

OPTIONS & ACCESSORIES

- Customization: multiple spec options, can be customized upon requirements

MOUNTING:

Suspended, ceiling mounted with correct accessories

APPLICATION AREAS

Indoor, Outdoor, Commercial, Residential, Retail, Hospitality

TECHNICAL DATA

LBLNEON16 - SINGLE COLOUR

LAMP	LED
TOTAL POWER (W)	16W/m
SYSTEM OUTPUT (LM)	1156 / 1270 / 1457 / 1466 / 1473 / 1362LM/m
EFFICACY (LM/W)	71.6 / 84.3 / 90.3 / 90.5 / 92.8 / 85.1
CCT (K)	2400 / 2700 / 3000 / 4000 / 5200 / 6500K
CRI (Ra)	80
BEAM ANGLE	360°
OPERATING VOLTAGE-VAC	24V DC
OPERATING TEMP °C	-20°C TO 60°C
STORAGE TEMP °C	-20°C TO 70°C
DIMMING RANGE	as per Dimming Protocols
DIMENSIONS	D:φ23 x L:5000mm
MIN CUT LENGTH	35.71mm

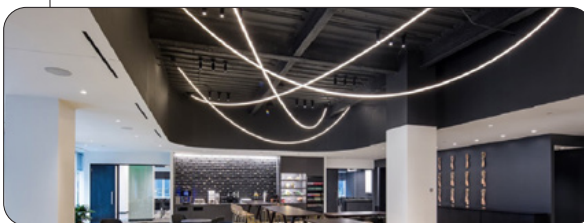

E&OE MAY OCCUR

LBLNEON16 - COLOUR

24V SPECIAL STRIPS
WATERPROOF

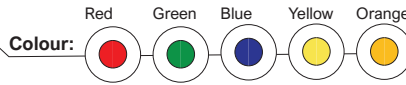
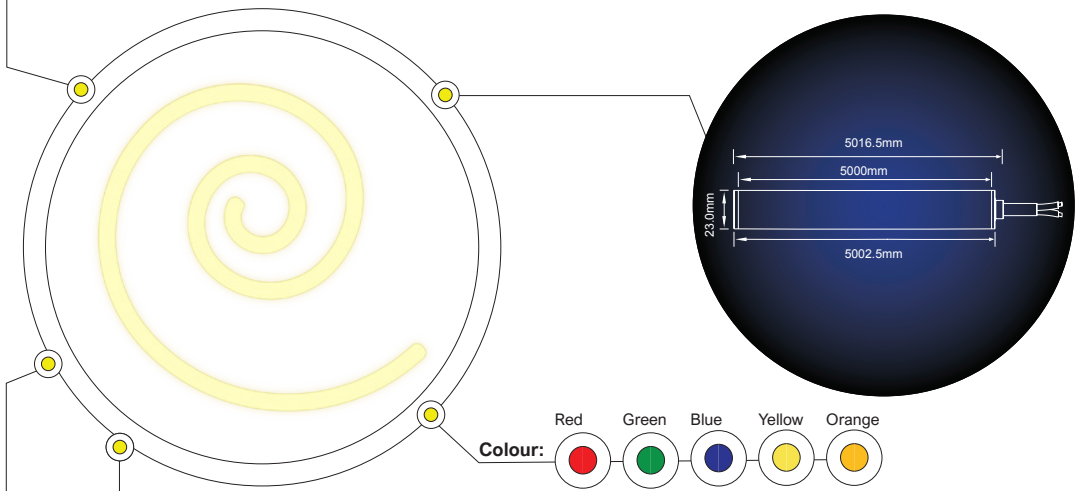

+ IP 65

LOA

3 YRS

ldt

FLX



PHYSICAL DATA

FEATURES

- Material: Silicone extrusion
- Superior design with exquisite craftsmanship ensure stable and reliable performance
- Flexibility: 360 bending, minimum bend diameter 120mm
- Saltwater resistant, UV resistant, Temporary immersion protection, Solvent resistant, Flame resistant
- Dimmable, 5m Reel

OPTIONS & ACCESSORIES

- Customization: multiple spec options, can be customized upon requirements

MOUNTING:

Suspended, ceiling mounted with correct accessories

APPLICATION AREAS

Indoor, Outdoor, Commercial, Residential, Retail, Hospitality

TECHNICAL DATA

LBLNEON16-RED

LBLNEON16-GREEN

LBLNEON16-BLUE

LBLNEON16-YELLOW

LBLNEON16-ORANGE

LAMP	LED	LED	LED	LED	LED
TOTAL POWER (W)	16W/m	16W/m	16W/m	16W/m	16W/m
SYSTEM OUTPUT (LM)	435LM/m	1338LM/m	315LM/m	201LM/m	393LM/m
EFFICACY (LM/W)	27.2	83.6	19.7	12.6	24.6
CCT (K)	RED	GREEN	BLUE	YELLOW	ORANGE
CRI (Ra)	80	80	80	80	80
BEAM ANGLE	360°	360°	360°	360°	360°
OPERATING VOLTAGE-VAC	24V DC	24V DC	24V DC	24V DC	24V DC
OPERATING TEMP °C	-20°C TO 60°C	-20°C TO 60°C	-20°C TO 60°C	-20°C TO 60°C	-20°C TO 60°C
STORAGE TEMP °C	-20°C TO 70°C	-20°C TO 70°C	-20°C TO 70°C	-20°C TO 70°C	-20°C TO 70°C
DIMMING RANGE	as per Dimming Protocols				
LAMP DIMENSIONS	D:φ23 x L:5000mm	D:φ23 x L:5000mm	D:φ23 x L:5000mm	D:φ23 x L:5000mm	D:φ23 x L:5000mm
MIN CUT LENGTH	35.71mm	35.71mm	35.71mm	35.71mm	35.71mm

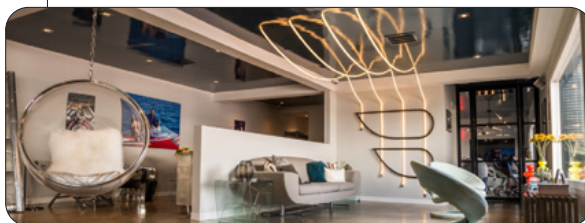

E&OE MAY OCCUR

LBLNEONFLEX6RGB24V

24V SPECIAL STRIPS
WATERPROOF

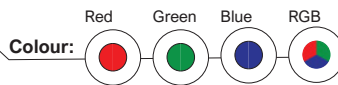
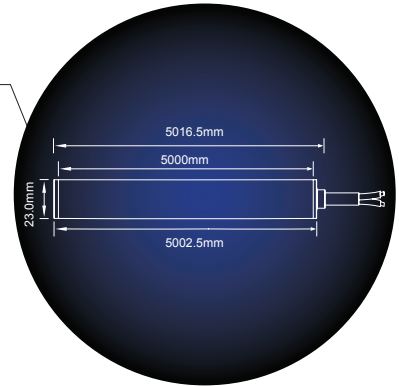
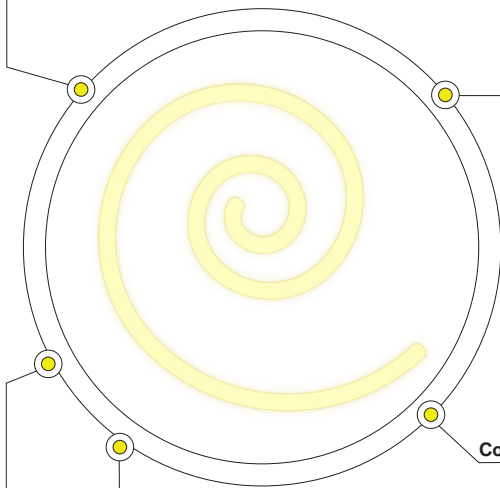

+IP 65

LOA

3 YRS

ldt

FLX



PHYSICAL DATA

FEATURES

- Material: Silicone extrusion
- Superior design with exquisite craftsmanship ensure stable and reliable performance
- Flexibility: 360 bending, minimum bend diameter 120mm
- Saltwater resistant, UV resistant, Temporary immersion protection, Solvent resistant, Flame resistant
- Dimmable, 5m Reel

OPTIONS & ACCESSORIES

- Customization: multiple spec options, can be customized upon requirements

MOUNTING:

Suspended, ceiling mounted with correct accessories

APPLICATION AREAS

Indoor, Outdoor, Commercial, Residential, Retail, Hospitality

TECHNICAL DATA

LBLNEONFLEX6RGB24V

LAMP	LED
TOTAL POWER (W)	6.4 / 6.4 / 6.4 / 19.2W/m
SYSTEM OUTPUT (LM)	108 / 498 / 103 / 696LM/m
EFFICACY (LM/W)	17.8 / 67.0 / 15.6 / 35.4
CCT (K)	R / G / B / RGB
BEAM ANGLE	360°

OPERATING VOLTAGE-VAC	24V DC
OPERATING TEMP °C	-20°C TO 60°C
STORAGE TEMP °C	-20°C TO 70°C
DIMMING RANGE	as per Dimming Protocols
LAMP DIMENSIONS	D:φ23 x L:5000mm
MIN CUT LENGTH	41.66mm

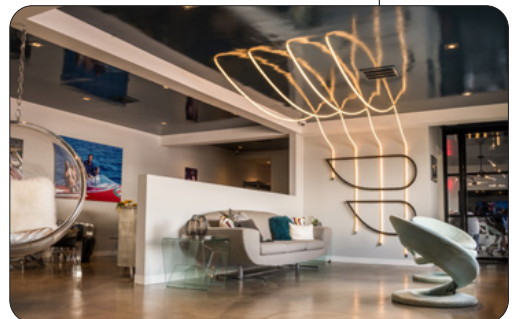
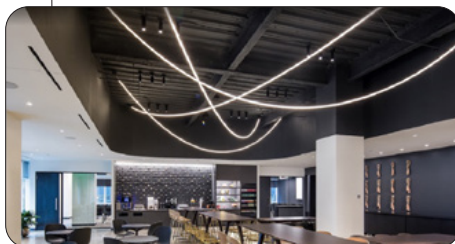

E&OE MAY OCCUR

CANOPY & END CAP SET

CEILING KIT

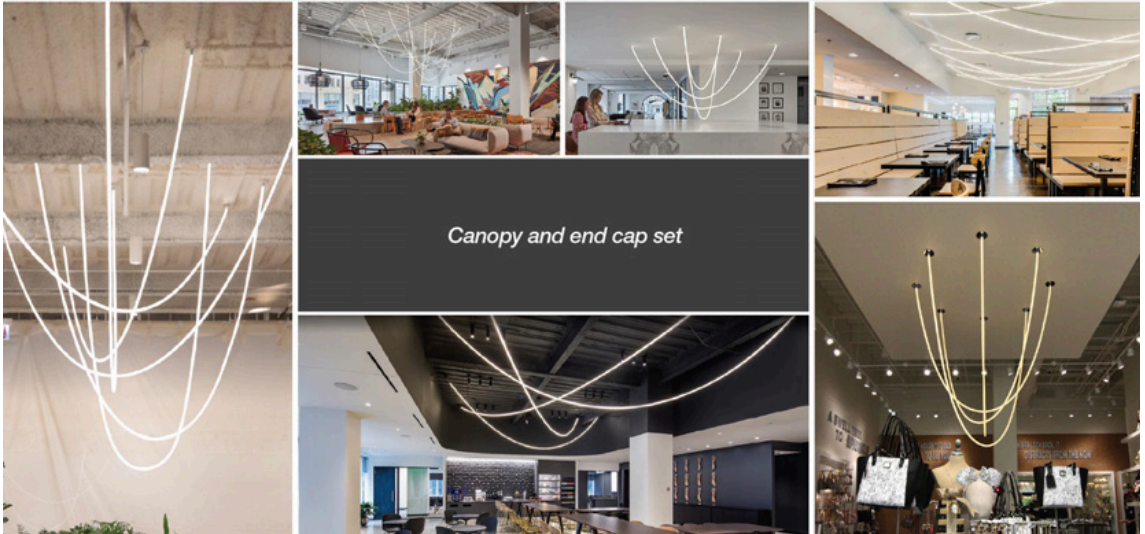

Canopy and end cap set



NCR23 Ceiling hardware



NCR23 Connector

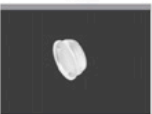

Silicone Plug



Ceiling - hardware end-cap



Hexagon screw(M3*5)



Self-tapping screw (PA3*16)

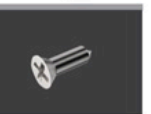

Countersunk head self-tapping screw(KA1.6*6)

LED STRIP LIGHTING - 24V STRIPS - SPECIAL - WATERPROOF - LBLINE016 - CANOPY & END CAP SET

E&OE MAY OCCUR

HARDWARE WIRE & END CAP SET

CEILING KIT



LED STRIP LIGHTING - 24V STRIPS - SPECIAL - WATERPROOF - LBLNEON16 - HARDWARE WIRE & END CAP SET

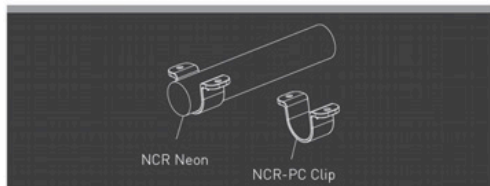
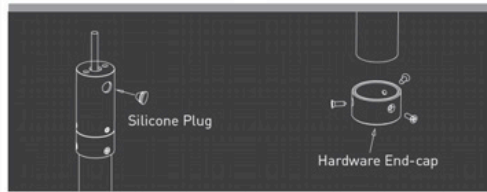

NCR23 Plastic Clip



Screw [3*13mm]

E&OE MAY OCCUR

HARDWARE WIRE & PC TUBE SET

CEILING KIT

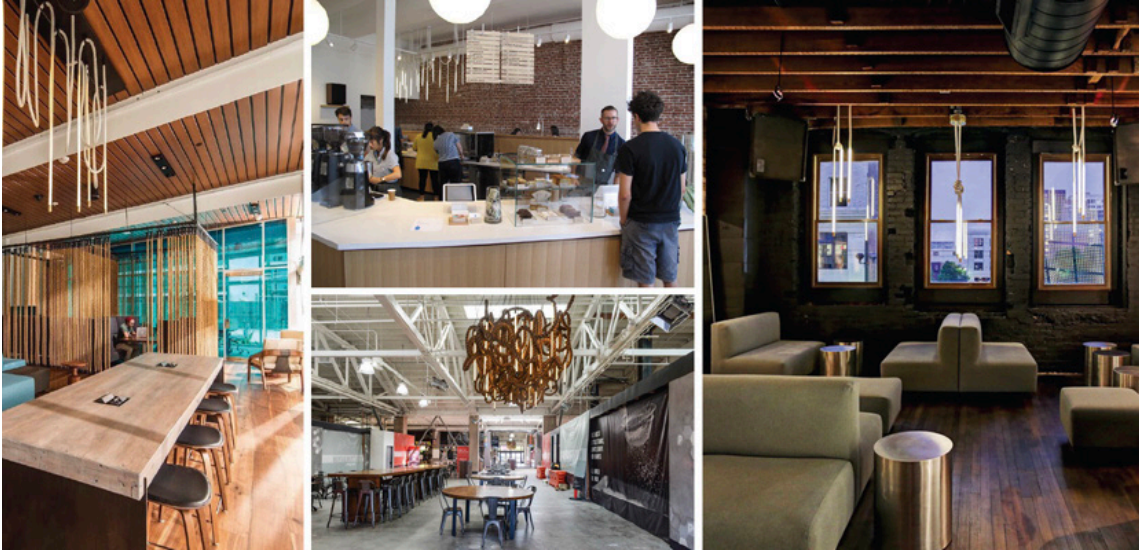

Hardware front-cap for PC tube Ceiling hardware Hardware end-cap for PC tube PC Tube Silicone O-ring Silicone plug

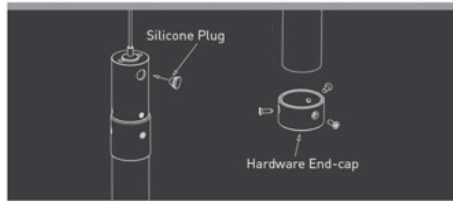

Countersunk head self-tapping Hexagon screw (M3*5) Wire locker Transparent wire Connector Wire fastener Self-tapping screw (PA3*16)

E&OE MAY OCCUR

METAL POLE & CANOPY SET

PENDANT KIT

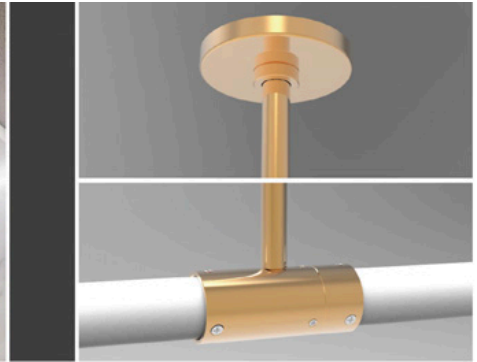
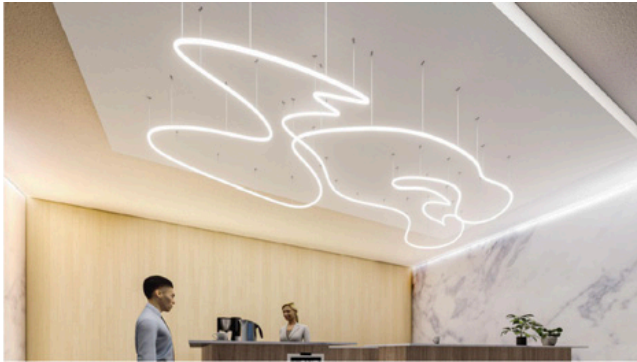

Pendant Pole & Metal Ring

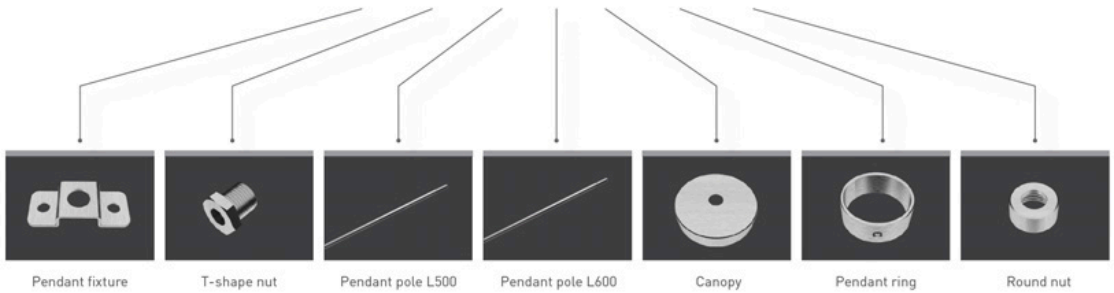

Metal Canopy

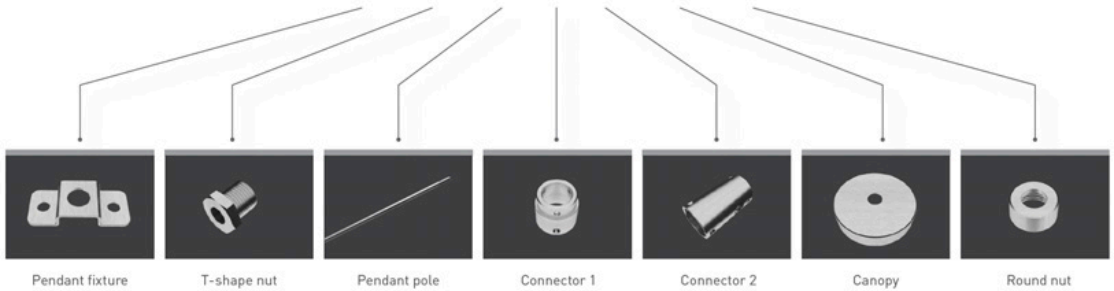

E&OE MAY OCCUR

COMPONENT LIST

360° NEON FLEX



LBLNEON CEILING
HARDWARE



LBLNEON
CONNECTOR



SILICONE PLUG



CEILING - END CAP



HEXAGON SCREW
(M3*5)



SELF-TAPPING
SCREW (PA3*16)



COUNTERSUNK HEAD
SCREW (KA1.6*6)



LBLNEON
PLASTIC CLIP



SCREW (3*13mm)



LBLNEON BRACKET



T-SHAPE NUT



PENDANT POLE L500



PENDANT POLE L600



CANOPY



PENDANT RING



ROUND NUT



LBLNEON
CONNECTOR 1



LBLNEON
CONNECTOR 2



HARDWARE FRONT
CAP FOR PC TUBE



HARDWARE END CAP
FOR PC TUBE



PC TUBE



SILICONE O-RING



WIRE LOCKER



TRANSPARENT WIRE



CONNECTOR



WIRE FASTENER

> ACCESSORIES

COMMERCIAL & ARCHITECTURAL

LED STRIP LIGHTING - ACCESSORIES



Project: Meda Clinic Stellenbosch

ACCESSORIES

STRIP LIGHTING
ACCESSORIES

Accessories



**CD_IR-MS
MINI PIR SWITCH**



**LBLMSWITCH
MAGNETIC SWITCH**

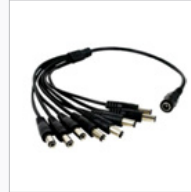

**LEDCONNBNW
CONNECTORS**



LEDEXTA**CLIP
CLIPS**



LEDEXTA**END
END CAPS**

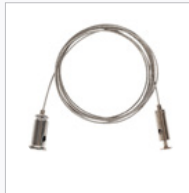

**P410ARC
SUSPENSION CABLES**

LED STRIP LIGHTING - ACCESSORIES

> REMOTE CONTROLS

COMMERCIAL & ARCHITECTURAL



M1 LED MINI RF DIM

**LED REMOTE
DIMMER / CONTROLLER**

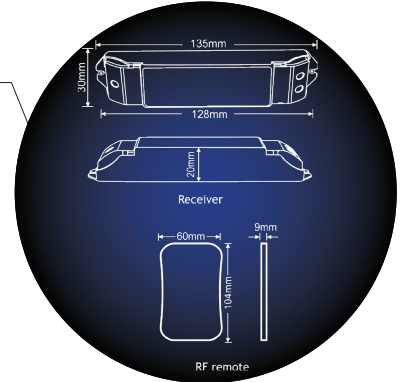
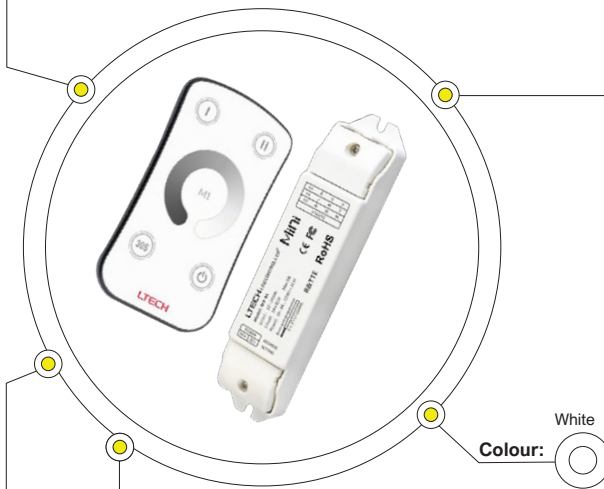

+ IP 20



5 YRS

PHYSICAL DATA

FEATURES

- M1 RF Remote & M3-3A Dimmer (Controller) for single colour dimming application
- The LED Mini 1 uses a Radio Frequency signal at 433.92 MHz and can reach about 40-50 meters
- LED Strips can be easily dimmed with the touch remote
- The 3x3A LED Receiver RF Mini is included with this product
- Comes in a set of the M3-3A Controller and the M1 Remote
- Protection includes: Reverse Polarity, LED Output Short,

- Overload and Restart after Protection
- It remembers its settings in case of power failure!

OPTIONS & ACCESSORIES

- M3-3A Controller and Remote available separately

MOUNTING: Surface

APPLICATION AREAS

LED Lighting Applications

TECHNICAL DATA

LEDCTMM1

MATERIAL	PLASTIC
TYPE	SINGLE COLOUR DIMMER
OUTPUT POWER	108W@12V 216W@24V
INPUT VOLTAGE	12 - 24V DC
OUTPUT CURRENT (MA)	3000MA
AMPERE (A)	9A (Max 3Ax3CH)
REMOTE WORKING VOLTAGE	3V (Battery CR2032)
CONTROL OUTPUT SIGNAL	RF, PWM-CV
FREQUENCY	433.92 MHz
REMOTE DISTANCE	30m
CONTROL ZONES	1
NUMBER OF CHANNELS	1
FUNCTIONS	PROGRAMMABLE
OPERATING TEMP	-30°C to 55°C
WEIGHT (KG) - CONTROLLER	0.47KG
WEIGHT (KG) - REMOTE	0.04KG
DIMENSIONS - CONTROLLER	L:135 x W:30 x H:20mm
DIMENSIONS - REMOTE	L:104 x W:60 x H:90mm

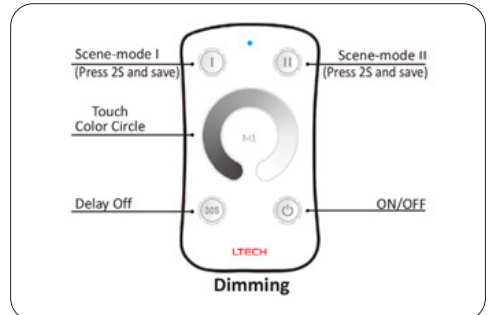

E&OE MAY OCCUR

M8 RGBW CONTROLLER

LED RGB
REMOTE & CONTROLLER

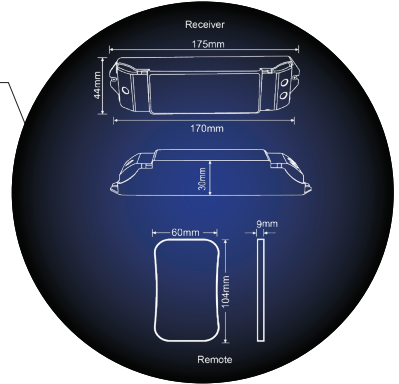

PHYSICAL DATA

FEATURES

- The M4-5A controller is an RGBW 4 x 5A controller
- This product comes in a set and includes the M4-5A Controller and the M8 Remote
- It works on both 12V and 24V
- Can run roughly 7 meters of 12V 19.2W RGBW strip and 15 meters of 24V 19.2W RGBW strip
- Protection includes: Reverse Polarity, LED Output Short, Overload and Restart after Protection

- It remembers its settings in case of power failure!

OPTIONS & ACCESSORIES

- M4-5A Controller and the M8 Remote available separately

MOUNTING: Surface

APPLICATION AREAS: LED Lighting Applications

+ IP 20



5 YRS

TECHNICAL DATA

LEDCTMM8

MATERIAL	PLASTIC
TYPE	RGBW DIMMER
OUTPUT POWER	100W @ 5V 240W @ 12V 480W @ 24V
INPUT VOLTAGE	5 - 24V DC
OUTPUT CURRENT (MA)	5000MA
AMPERE (A)	20A (5A x 4CH)
LED OUTPUTS	4
RECEIVER MODEL	M4-5A
REMOTE WORKING VOLTAGE	DC3V (Battery CR2032)
CONTROL OUTPUT SIGNAL	RF, PWM-CV
CONTROL	BUTTONS CONTROL PANEL
FREQUENCY	433.92 MHz
REMOTE DISTANCE	40m
CONTROL ZONES	1
NUMBER OF CHANNELS	4
FUNCTIONS	PROGRAMMABLE
REMOTE MODEL	M4/M8
OPERATING TEMPERATURE	-30°C TO 55°C
WEIGHT (KG) - CONTROLLER	0.42KG
WEIGHT (KG) - REMOTE	0.125KG
DIMENSIONS - CONTROLLER	L:135 x W:30 x H:20mm
DIMENSIONS - REMOTE	L:104 x W:58 x H:90mm

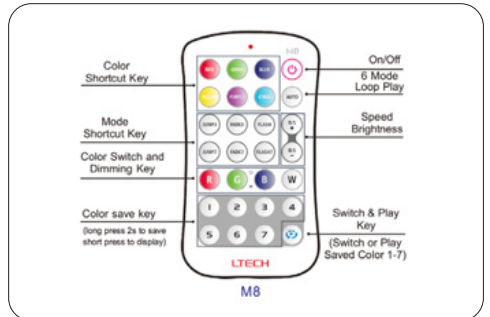

E&OE MAY OCCUR

> DRIVERS

DIMMABLE DRIVERS



DRIVERS - DIMMABLE DRIVERS

Project Ernie Els Wines | Design: Rumour Has It | Photography: Charles Russell

DALI / PUSH DIMMABLE DRIVERS

DIMMABLE DRIVERS

DRIVERS - DIMMABLE DRIVERS - DALI / PUSH DIMMABLE DRIVERS

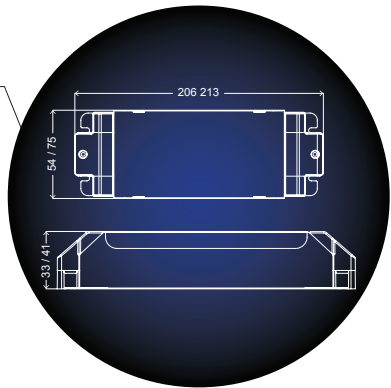
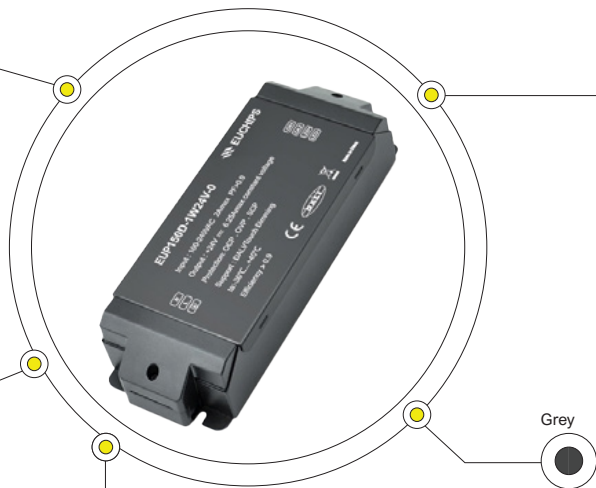

- + IP 20
-
- LOA
- 3 YRS

PHYSICAL DATA

FEATURES

- Single-channel constant voltage output
- Supports Push Dim and DALI Dimming
- Dimming effect smooth, no flicker
- Over-current, Short-circuit, Over-voltage and Over-temperature Protection

MOUNTING

Subject to Application

APPLICATION AREAS

LED Lighting Applications

TECHNICAL DATA

LBL75WNP24VDD

LBL150WNP24VDD

MATERIAL	METAL	METAL
TYPE	DALI / PUSH DRIVER	DALI / PUSH DRIVER
OUTPUT POWER	75W	150W
INPUT VOLTAGE	100-240V	100-240V
OUTPUT VOLTAGE	DC24V	DC24V
AMPERE (A)	3.1A	6.25A
DIMENSIONS	L:213 x B:54 x H:33mm	L:206 x B:75 x H:41mm

DALI / PUSH DIM DRIVERS

DIMMABLE DRIVERS

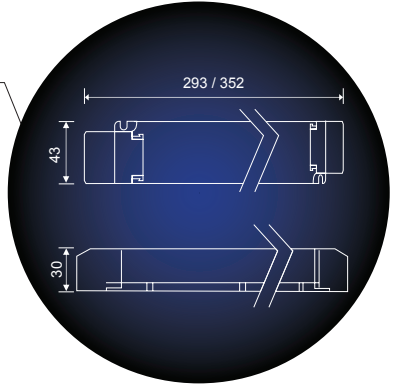

Colour:  White

+ IP 20



LOA

5 YRS

PHYSICAL DATA

FEATURES

- Dimming interface: DALI, Push Dim
- Fully-protected plastic housing with removable end cover which is for the convenient adjustments of length of drivers
- Dimmable 0.1 -100%, flicker-free, high-frequency exemption level
- High-efficiency driver with innovative thermal management technology, intelligent power life protection
- Low standby power loss
- Compliant with Safety Extra Low Voltage Standard

- Over-heat / Over voltage / Over load / Short circuit protection / Recover automatically
- Rated life: 50 000hrs

MOUNTING

- Subject to application
- Breathable environment

APPLICATION AREAS

LED Lighting Applications

TECHNICAL DATA

LED75CTDALI2V

LED75CTDALI24V

LED150CTDALI2V

LED150CTDALI24V

MATERIAL	PLASTIC	PLASTIC	PLASTIC	PLASTIC
TYPE	DALI / PUSH DIM	DALI / PUSH DIM	DALI / PUSH DIM	DALI / PUSH DIM
OUTPUT POWER	75W	75W	150W	150W
INPUT VOLTAGE	220-240V	220-240V	220-240V	220-240V
OUTPUT VOLTAGE	DC 12V	DC 24V	DC 12V	DC 24V
AMPERE (A)	6.25A	3.12A	12.5A	6.25A
DIMENSIONS	L:293 x B:43 x H:30mm	L:293 x B:43 x H:30mm	L:352 x B:43 x H:30mm	L:352 x B:43 x H:30mm

DALI Connection



Push DIM Connection



E&OE MAY OCCUR

TRIAC DIMMABLE DRIVERS

DIMMABLE DRIVERS

DRIVERS - DIMMABLE DRIVERS - TRIAC DIMMABLE DRIVERS

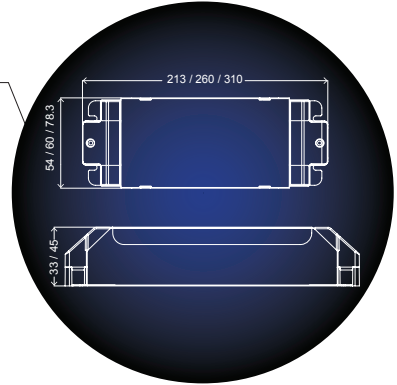

PHYSICAL DATA

FEATURES

- Single-channel constant voltage output
- Supports TRIAC and trailing edge (ELV) dimmer and compatible with the systems of various brands
- Dimming effect smooth, no flicker
- Over-current, Short-circuit, Over-voltage and Over-temperature Protection

MOUNTING

Subject to Application

APPLICATION AREAS

LED Lighting Applications

TECHNICAL DATA

LBL75WNWP12VTD

LBL150WNWP12VTD

LBL75WNWP24VTD

LBL150WNWP24VTD

MATERIAL	METAL	METAL	ALUMINIUM	ALUMINIUM
TYPE	LED TRIAC DRIVER	LED TRIAC DRIVER	LED TRIAC DRIVER	LED TRIAC DRIVER
OUTPUT POWER	75W	150W	75W	150W
INPUT VOLTAGE	200-240V	200-240V	200-240V	200-240V
OUTPUT VOLTAGE	DC12V	DC12V	DC24V	DC24V
AMPERE (A)	6.2A	12.5A	3.1A	6.3A
DIMENSIONS	L:213 x B:54 x H:33mm	L:260 x B:78.3 x H:45mm	L:213 x B:54 x H:33mm	L:310 x B:60 x H:45mm

TRIAC / ELV / PUSH DIM DRIVERS

DIMMABLE DRIVERS

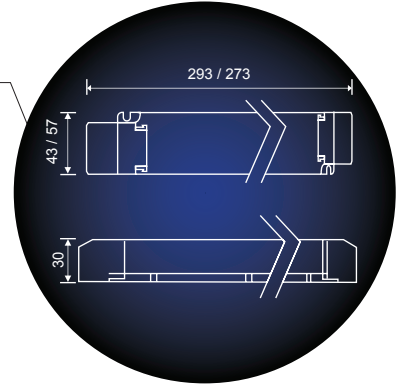

White
Colour:

+ IP 20



LOA

5 YRS

PHYSICAL DATA

FEATURES

- Dimming Interface: Leading edge (TRIAC), Trailing edge (ELV) phase-cut and Push DIM driver
- Fully-protected plastic housing with removable end cover which is for the convenient adjustments of length of drivers
- With soft-on and fade-in function, visually more comfortable
- Dimmable 0.1 -100%, flicker-free, high-frequency exemption level
- High efficiency driver with innovative thermal management technology, intelligent power life protection

- Over load / Over temp / Short circuit / Over-heat / Over voltage protection / Recover automatically

MOUNTING

- Subject to application
- Breathable environment

APPLICATION AREAS

LED Lighting Applications

TECHNICAL DATA

LED75TD12

LED75TD24

LED150TD12

LED150TD24

	LED75TD12	LED75TD24	LED150TD12	LED150TD24
MATERIAL	PLASTIC	PLASTIC	PLASTIC	PLASTIC
TYPE	TRIAC / ELV / PUSH DIM	TRIAC / ELV / PUSH DIM	TRIAC / ELV / PUSH DIM	TRIAC / ELV / PUSH DIM
OUTPUT POWER	75W	75W	150W	150W
INPUT VOLTAGE	220-240V	220-240V	220-240V	220-240V
OUTPUT VOLTAGE	DC 12V	DC 24V	DC 12V	DC 24V
AMPERE (A)	6.25A	3.12A	12.5A	6.25A
DIMENSIONS	L:293 x B:43 x H:30mm	L:293 x B:43 x H:30mm	L:273 x B:57 x H:37mm	L:273 x B:57 x H:37mm

TRIAC Connection



Push DIM Connection



Short press to on/off, long press to dim.

* Push DIM is invalid for DC voltage input.

Dimming interface priority: First Triac, next Push DIM.

E&OE MAY OCCUR

0-10V / PUSH DIM DRIVERS

DIMMABLE DRIVERS

DRIVERS – DIMMABLE DRIVERS – 0-10V / PUSH DIM DRIVERS

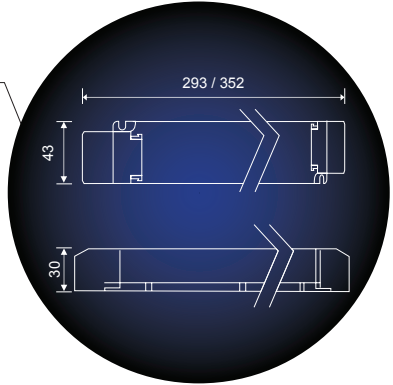
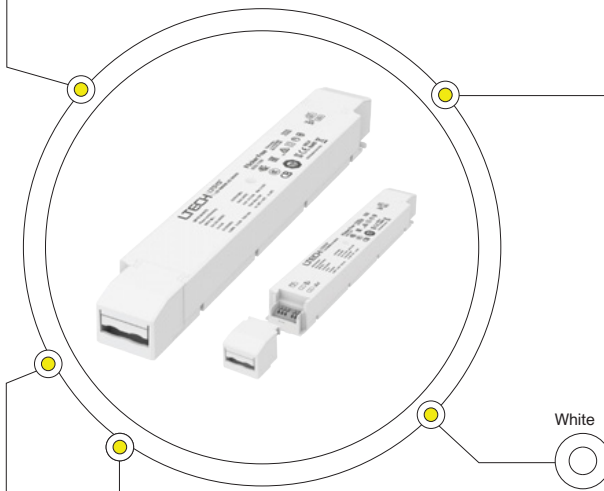

+ IP 20



LOA

5 YRS

PHYSICAL DATA

FEATURES

- Dimming interface: 0-10V(1-10V/10V PWM/RX), Push Dim
- Fully-protected plastic housing with removable end cover which is for convenient adjustments of length of drivers
- With soft-on and fade-in function, visually more comfortable
- Dimmable 0.1 -100%, flicker-free, high-frequency exemption level, rated life: 50 000hrs
- Automatic recognition of 0-10V, 1-10V input signal
- Ultra-low consumption of 0-10V ports
- High efficiency driver with innovative thermal management

technology, intelligent power life protection

- Over-heat / Over voltage / Over load / Short circuit protection / Recover automatically

MOUNTING

- Subject to application
- Breathable environment

APPLICATION AREAS

LED Lighting Applications

TECHNICAL DATA

LED75ADDAL12V

LED75ADDAL124V

LED150ADDAL12V

LED150ADDAL124V

	LED75ADDAL12V	LED75ADDAL124V	LED150ADDAL12V	LED150ADDAL124V
MATERIAL	PLASTIC	PLASTIC	PLASTIC	PLASTIC
TYPE	DALI / PUSH DIM	DALI / PUSH DIM	DALI / PUSH DIM	DALI / PUSH DIM
OUTPUT POWER	75W	75W	150W	150W
INPUT VOLTAGE	220-240V	220-240V	220-240V	220-240V
OUTPUT VOLTAGE	DC 12V	DC 24V	DC 12V	DC 24V
AMPERE (A)	6.25A	3.12A	12.5A	6.25A
DIMENSIONS	L:293 x B:43 x H:30mm	L:293 x B:43 x H:30mm	L:352 x B:43 x H:30mm	L:352 x B:43 x H:30mm

0-10V Connection



Push DIM Connection



Dimming interface priority: First 0-10V, next Push DIM.

E&OE MAY OCCUR

> NON-DIMMABLE DRIVERS

COMMERCIAL & ARCHITECTURAL



POWER SUPPLIES

NON DIMMABLE DRIVERS

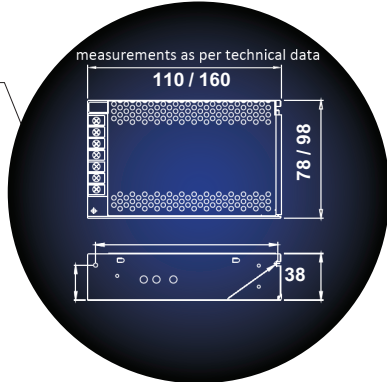

Silver

+ IP 20



LOA

3 YRS

PHYSICAL DATA

FEATURES

- Overload Short-circuit Protection
- Compact / Slim size for easy installation
- High transfer efficiency
- Wide input range
- 100% full loading
- 100% burn-in tested

MOUNTING

Subject to application

APPLICATION AREAS

LED Lighting Applications

TECHNICAL DATA

LBL60NWP12V

LBL60NWP24VJ

LBL120NWP24V

LBL150NWP12VJ

MATERIAL	ALUMINIUM	ALUMINIUM	ALUMINIUM	ALUMINIUM
TYPE	LED DRIVER	LED DRIVER	LED DRIVER	LED DRIVER
OUTPUT POWER	100-250V	100-250V	100-250V	100-250V
INPUT VOLTAGE	DC 12V	DC 24V	DC 24V	DC 12V
OUTPUT VOLTAGE	60W	60W	120W	150W
AMPERE (A)	5A	2.5A	5A	12.5A
WEIGHT (KG)	270G	270G	450G	450G
DIMENSIONS	L:110 x B:78 x H:35mm	L:110 x B:78 x H:35mm	L:160 x B:98 x H:38mm	L:160 x B:98 x H:38mm

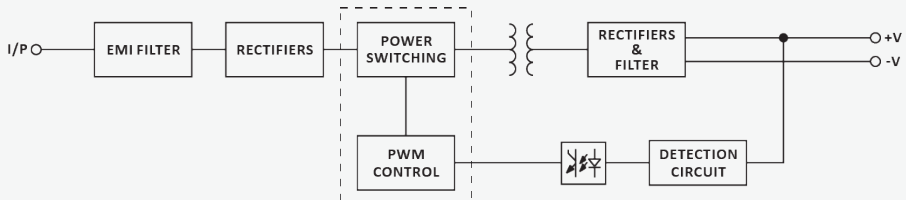

E&OE MAY OCCUR

DRIVERS - NON-DIMMABLE DRIVERS - POWER SUPPLIES

POWER SUPPLIES

NON DIMMABLE DRIVERS

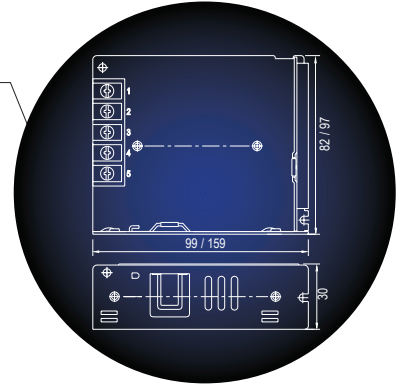

Colour: 

+ IP 20



LOA

3 YRS

PHYSICAL DATA

FEATURES

- Universal AC input / Full range
- AC input range selectable by switch on LBL150NWP
- Withstands 300VAC surge input for 5 seconds
- No load/power consumption between <math><0.2W</math> and <math><0.5W</math>
- Miniature size and 1U low profile
- High operating temperatures up to 70°C
- Protections: Short-circuit, Overload, Over-voltage cat III
- Over-temperature protection on LBL150NWP
- Cooling by free air convection

- Operating altitude up to 5000m
- Withstand 5G vibration test
- High efficiency, long life and high reliability
- LED indicator for power on
- 100% full load burn-in test

MOUNTING: Subject to application

APPLICATION AREAS

LED Lighting Applications

TECHNICAL DATA

	LBL35NWP	LBL50NWP	LBL75NWP	LBL100NWP	LBL150NWP
MATERIAL	ALUMINIUM	ALUMINIUM	ALUMINIUM	ALUMINIUM	ALUMINIUM
TYPE	LED DRIVER	LED DRIVER	LED DRIVER	LED DRIVER	LED DRIVER
OUTPUT POWER	35W / 36W	50.4W / 52.8W	72W / 76.8W	102W / 108W	150W / 156W
INPUT VOLTAGE	120-373V	120-373V	120-373V	120-373V	120-373V
OUTPUT VOLTAGE	DC 12V / 3A	DC 12V / 4.2A	DC 12V / 6A	DC 12V / 8.5A	DC 12V / 12.5A
AMPERE (A)	DC 24V / 1.5A	DC 24V / 2.2A	DC 24V / 3.2A	DC 24V / 4.5A	DC 24V / 6.5A
WEIGHT (KG)	230G	230G	250G	340G	480G
DIMENSIONS	L:99 x B:82 x H:30mm	L:99 x B:82 x H:30mm	L:99 x B:97 x H:30mm	L:159 x B:97 x H:30mm	L:159 x B:97 x H:30mm

BLOCK DIAGRAM FOR LBL35NWP

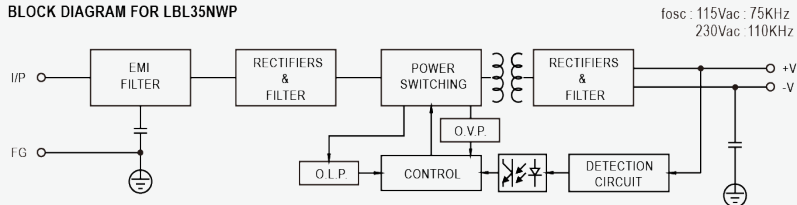

E&OE MAY OCCUR

> WATERPROOF DRIVERS

COMMERCIAL & ARCHITECTURAL

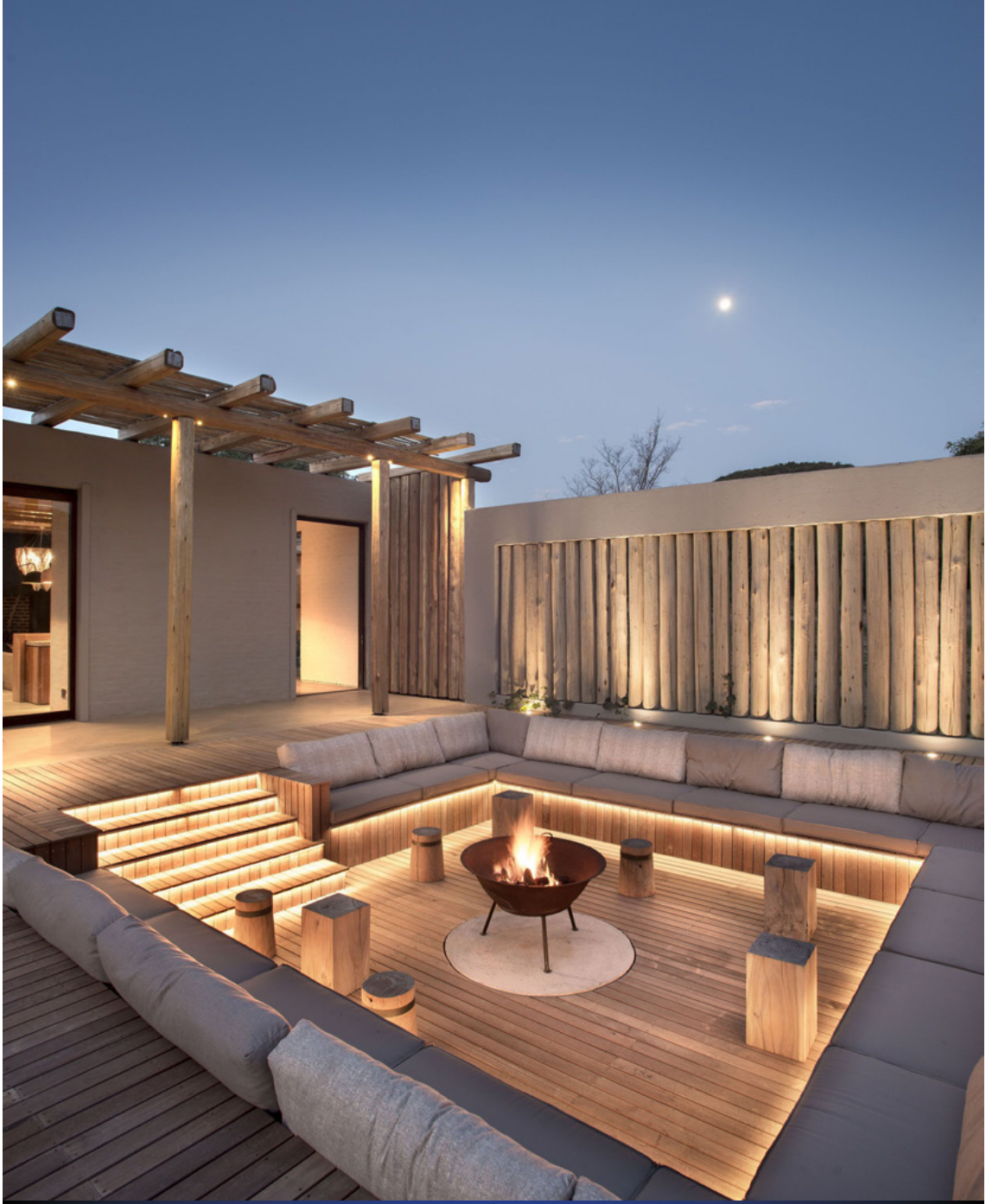

POWER SUPPLIES IP

WATERPROOF DRIVERS

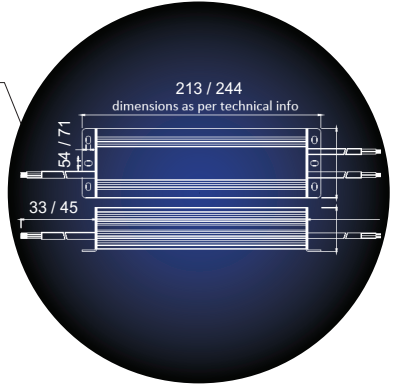

Colour:  Silver

+ IP 67



LOA

2 YRS

PHYSICAL DATA

FEATURES

- Overload Short-circuit Protection
- Compact / Slim size for easy installation
- High transfer efficiency
- Wide input range
- 100% full loading
- 100% burn-in tested

MOUNTING

Subject to Application

APPLICATION AREAS

LED Lighting Applications

TECHNICAL DATA

LBL60WP12VJ

LBL150WP12VJ

MATERIAL	ALUMINIUM	ALUMINIUM
TYPE	LED DRIVER	LED DRIVER
OUTPUT POWER	60W	150W
INPUT VOLTAGE	170-250V	170-250V
OUTPUT VOLTAGE	DC 12V	DC 12V
AMPERE (A)	5A	12.5A
DIMENSIONS	L:213 x B:54 x H:33mm	L:244 x B:71 x H:45mm

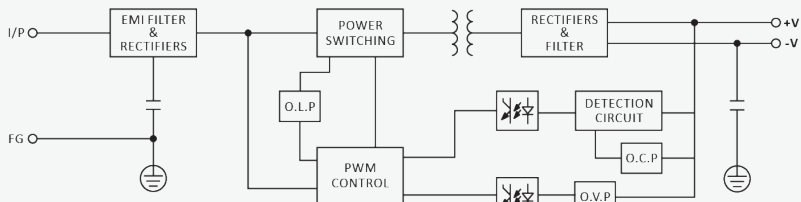

E&OE MAY OCCUR

POWER SUPPLIES IP

WATERPROOF DRIVERS

DRIVERS - DIMMABLE DRIVERS - DALI / PUSH DIMMABLE DRIVERS

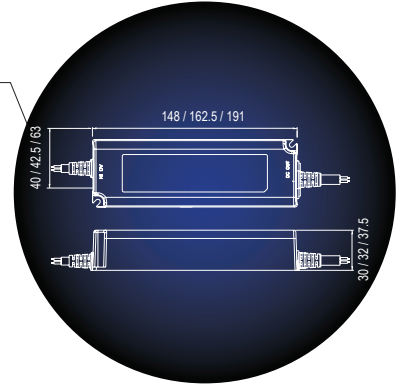

White

+ IP 67



LOA

3 YRS

PHYSICAL DATA

FEATURES

- Fully encapsulated, isolated plastic case
- Constant voltage design
- Universal AC input / Full range
- Withstand 300VAC surge input for 5 seconds
- Protections: Short circuit / Overload / Over voltage
- Cooling by free air convection
- Class II power unit, no FG, Pass LPS
- 100% full load burn-in test
- Low cost, high reliability

MOUNTING

- Subject to application
- 50mm gap between drivers
- Breathable environment

APPLICATION AREAS:

LED Lighting Applications

TECHNICAL DATA

LBL35WP

LBL60WP

LBL150WP

MATERIAL	ALUMINIUM	ALUMINIUM	ALUMINIUM
TYPE	LED DRIVER	LED DRIVER	LED DRIVER
OUTPUT POWER	36W	60W	120W / 151.2W
INPUT VOLTAGE	90-370V	90-370V	180-305V
OUTPUT VOLTAGE	DC 12V / 24V	DC 12V / 24V	DC 12V / 24V
AMPERE (A)	3A / 1.5A	5A / 2.5A	10A / 6.3A
DIMENSIONS	L:148 x B:40 x H:30mm	L:162.5 x B:42.5 x H:32mm	L:191 x B:63 x H:37.5mm

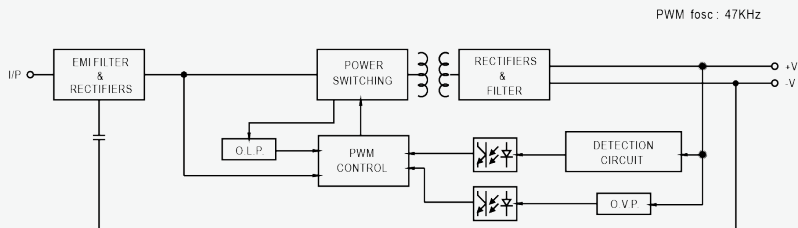

E&OE MAY OCCUR

> WALL

ART & MIRROR LIGHTING



LBLPL0114

ART & PICTURE LIGHTING

WALL - ART & MIRROR LIGHTING - LBLPL0114

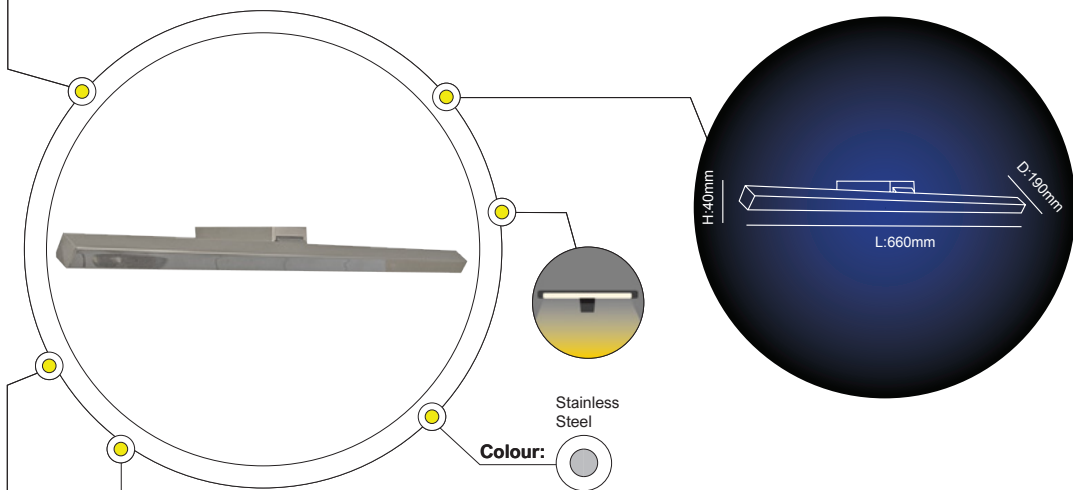

+ IP 20



1 YR

PHYSICAL DATA

FEATURES

- Material: stainless steel
- Modern slim design picture light
- Built in LED driver

MOUNTING

Surface, Wall

APPLICATION AREAS

Indoor, Commercial, Residential, Retail, Hospitality

TECHNICAL DATA

LBLPL0114

LAMP	LED
TOTAL POWER (W)	14W
OPERATING VOLTAGE-VAC	220-240V
DIMENSIONS	L:660 x D:190 x H:40mm

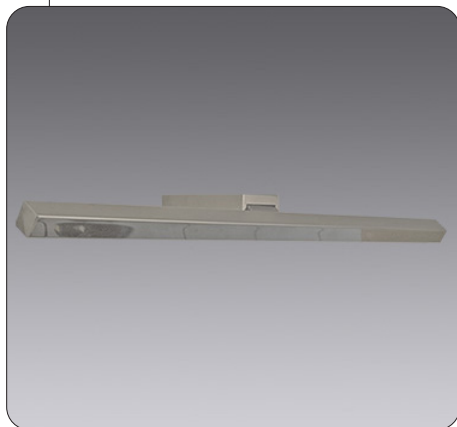

E&OE MAY OCCUR

LBLPL03

ART & PICTURE LIGHTING

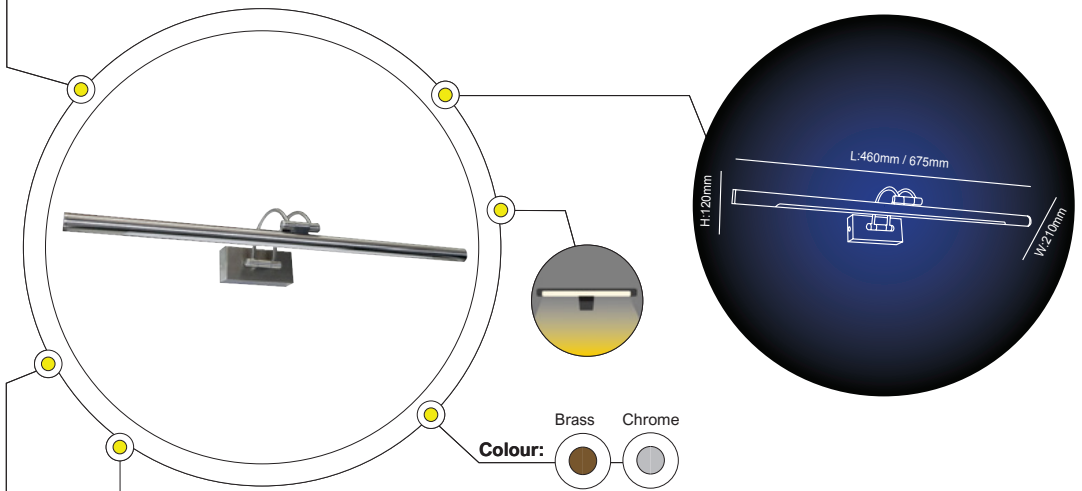

- + IP 20
-
- 1 YR

PHYSICAL DATA

FEATURES

- Body: Metal with diffuser
- Non-dimmable luminaire

MOUNTING

Surface, Wall

APPLICATION AREAS

Indoor, Commercial, Residential, Retail, Hospitality

TECHNICAL DATA

LBLPL038

LBLPL0312

LAMP	LED	LED
TOTAL POWER (W)	8W	12W
CCT (K)	3000K	3000K
OPERATING VOLTAGE-VAC	220-240V	220-240V
DIMENSIONS	L:460 x H:120 x W:210mm	L:675 x H:120 x W:210mm

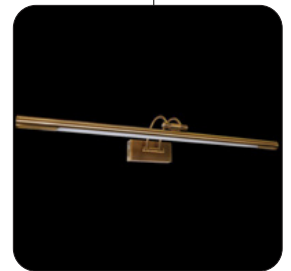

LBLPL04

ART & PICTURE LIGHTING

WALL - ART & MIRROR LIGHTING - LBLPL04

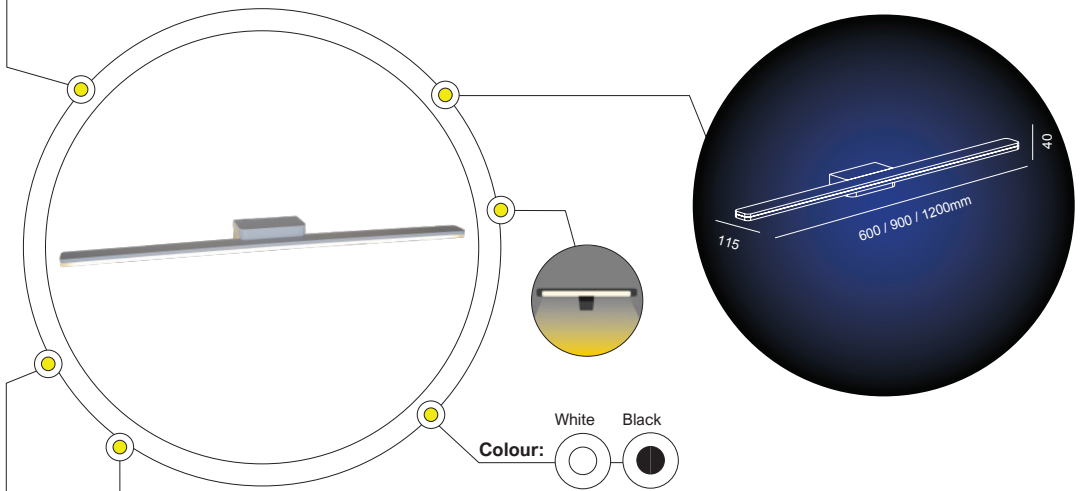

+ IP 54



LOA

3 YRS



PHYSICAL DATA

FEATURES

- Material: Die-cast aluminium
- The LBLPL04 is an indoor decorative light or mirror lamp in the bathroom
- Can be installed with the light beam facing either up or down
- TRIAC dimmable

OPTIONS & ACCESSORIES

- 600mm, 900mm and 1200mm lengths available for selection

MOUNTING: Surface, Wall

APPLICATION AREAS

Indoor, Commercial, Residential, Retail, Hospitality

TECHNICAL DATA

LBLPL04

LAMP	LED
TOTAL POWER (W)	10 / 14.5 / 18.8W
SYSTEM OUTPUT (LM)	610 / 884 / 1146LM
CCT (K)	3000K
CRI (Ra)	80
BEAM ANGLE	180°
OPERATING VOLTAGE-VAC	220-240V
DIMENSIONS	W:115 x H:40mm
LENGTHS	L:600 / 900 / 1200mm

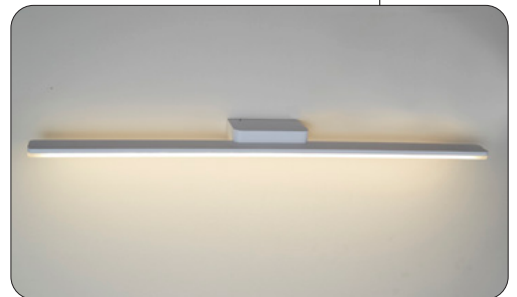

LBLP1028

ART & PICTURE LIGHTING

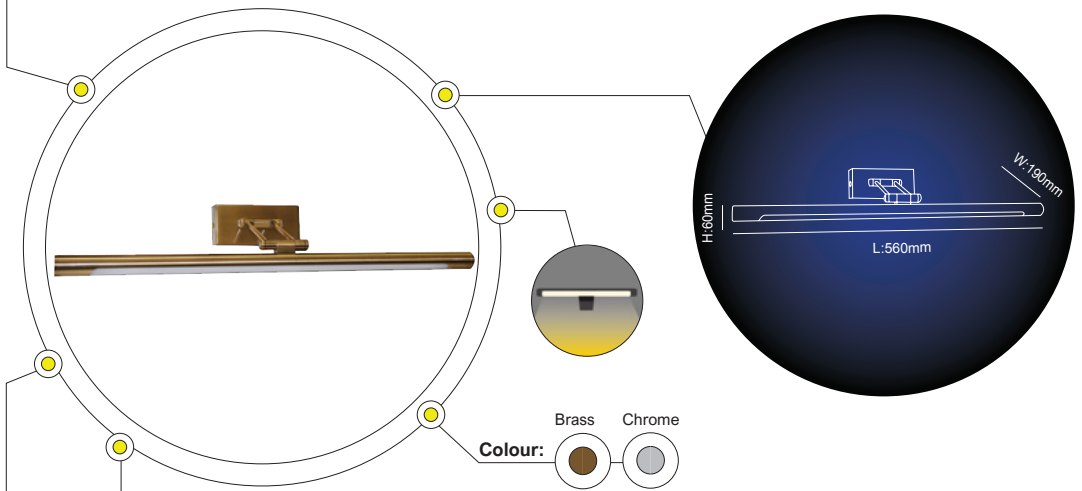

+ IP 20



✓ 1YR

PHYSICAL DATA

FEATURES

- Body: Metal with diffuser
- Non-dimmable luminaire

MOUNTING

Surface, Wall

APPLICATION AREAS

Indoor, Commercial, Residential, Retail, Hospitality

TECHNICAL DATA

LBLP1028

LAMP	LED
TOTAL POWER (W)	8W
CCT (K)	3000K
OPERATING VOLTAGE-VAC	220-240V
DIMENSIONS	L:560 x H:60 x W:190mm



E&OE MAY OCCUR

LBLBL015

BATHROOM WALL LIGHTS

WALL - ART & MIRROR LIGHTING - LBLBL015

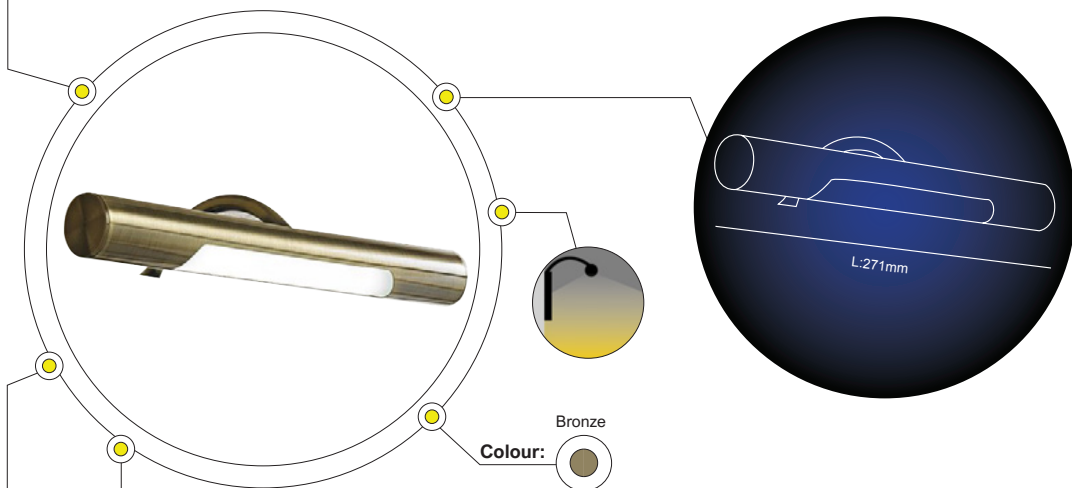

+ IP 44



5 YRS

PHYSICAL DATA

FEATURES

- Body: Iron and Polycarbonate with polycarbonate diffuser
- This luminaire offers medium illuminance with optimum lighting quality in the mirror
- Ideal for installation over cabinets, wooden frames and mirrors
- Alternating current LED technology
- No external driver

- No LED spares
- Easy Installation

MOUNTING

Surface, Wall

APPLICATION AREAS

Indoor, Commercial, Residential, Retail, Hospitality

TECHNICAL DATA

LBLBL015

LAMP	LED
TOTAL POWER (W)	5W
SYSTEM OUTPUT (LM)	500LM
CCT (K)	5700K
CRI (Ra)	80
BEAM ANGLE	141°
OPERATING VOLTAGE-VAC	220-240V
RATED LIFE (HRS)	36 000HRS
LENGTH	271mm



E&OE MAY OCCUR

LBLBL029

BATHROOM WALL LIGHTS

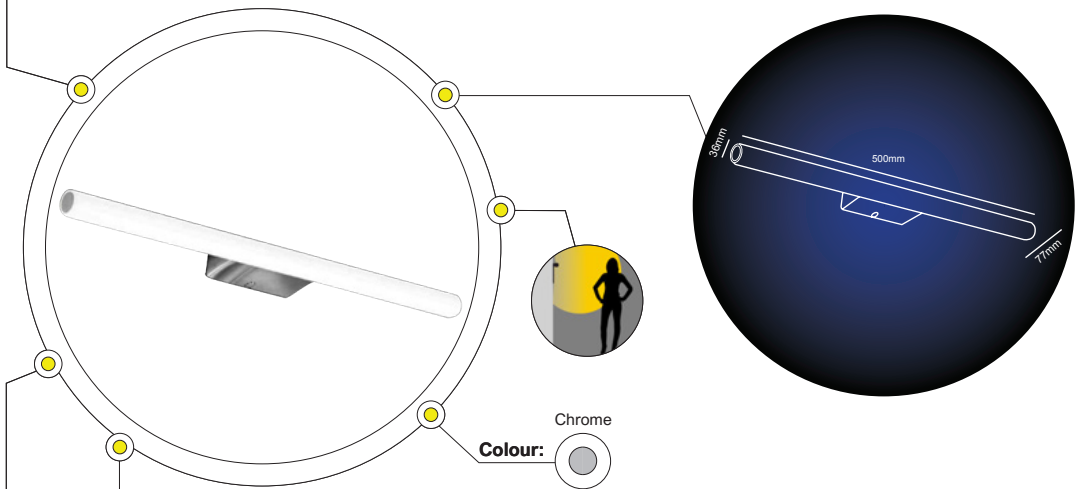

Chrome
Colour:

+ IP 44



5 YRS

PHYSICAL DATA

FEATURES

- Body: ABS with polycarbonate diffuser
- This luminaire offers multiple mounting options, high illuminance with optimum lighting quality in the mirror
- Ideal for wall installations
- Alternating current LED technology
- No external driver and LED spares
- Easy Installation and low environmental impact

OPTIONS & ACCESSORIES

- The range offers an over mirror light, available in 300mm, 500mm and 800mm for selection

MOUNTING

Surface, Wall

APPLICATION AREAS

Indoor, Commercial, Residential, Retail, Hospitality

TECHNICAL DATA

LBLBL029

LAMP	LED
TOTAL POWER (W)	9W
SYSTEM OUTPUT (LM)	865LM
CCT (K)	5700K
CRI (Ra)	80
BEAM ANGLE	210°
OPERATING VOLTAGE-VAC	220-240V
RATED LIFE (HRS)	36 000HRS
DIMENSIONS	W:77 x L:500m
LIGHT ROD DIAMETER	D:36mm



E&OE MAY OCCUR

LBLBL03

BATHROOM WALL LIGHTS

WALL - ART & MIRROR LIGHTING - LBLBL03

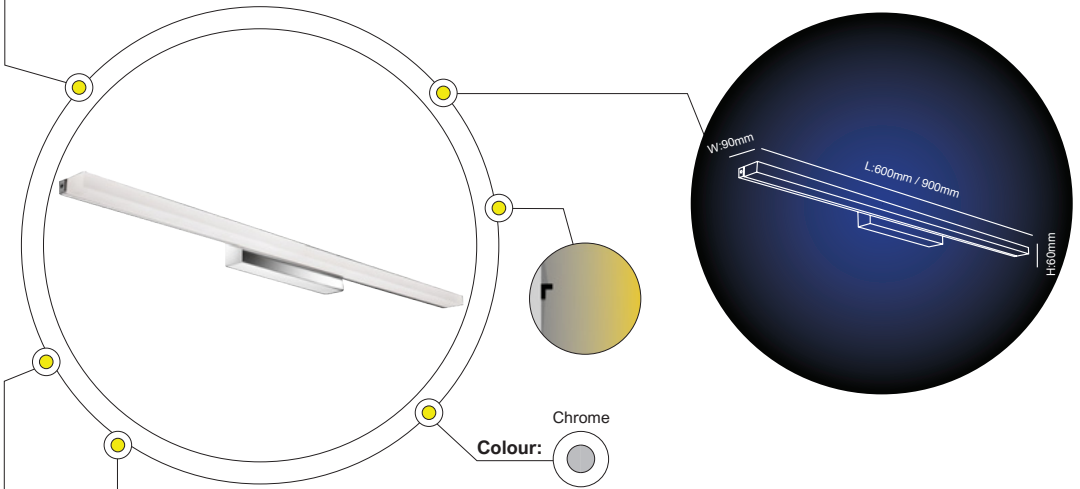

+IP 44



✓ 1YR

PHYSICAL DATA

FEATURES

- Body: Chrome with frosted acrylic diffuser
- The light is available in two lengths; 600 and 900mm
- Non-dimmable luminaire

MOUNTING

Surface, Wall

APPLICATION AREAS

Indoor, Commercial, Residential, Retail, Hospitality

TECHNICAL DATA

LBLBL03

LAMP	LED
TOTAL POWER (W)	12 / 18W
SYSTEM OUTPUT (LM)	540 / 810LM
CCT (K)	3000 / 4000K
OPERATING VOLTAGE-VAC	220-240V
LENGTHS	600 / 900mm
DIMENSIONS	H:60 x W:90mm

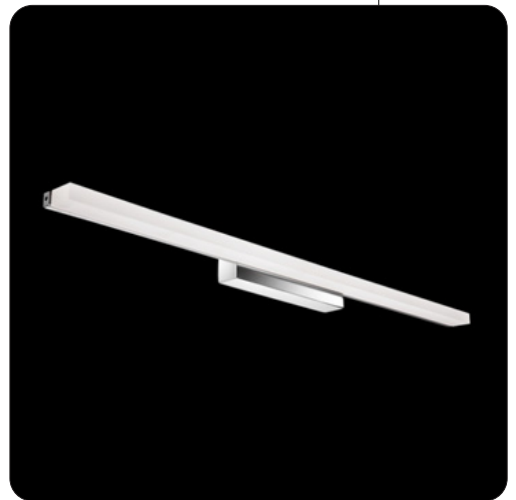

LBLBL04

BATHROOM WALL LIGHTS

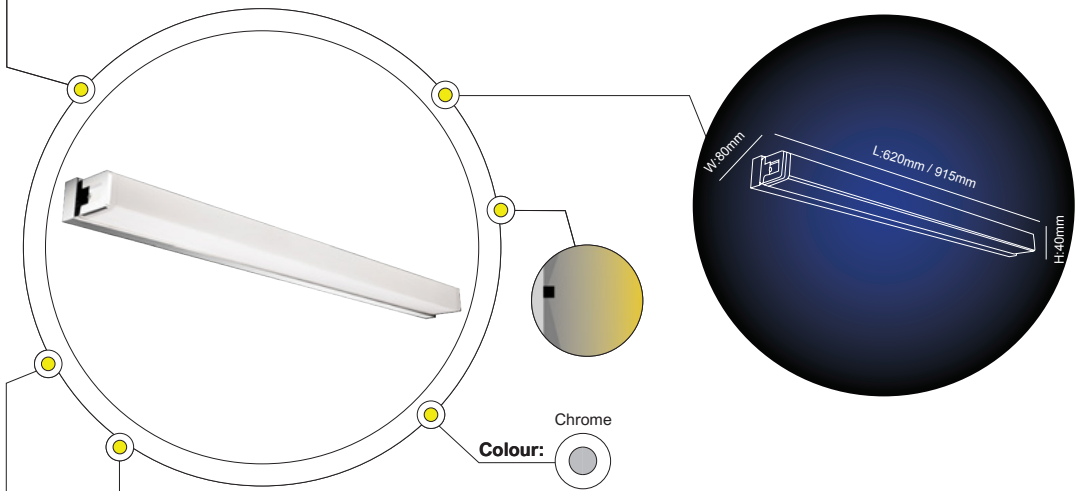

+ IP 44



✓ 1 YR

PHYSICAL DATA

FEATURES

- Body: Chrome with opal acrylic diffuser
- The light is available in two lengths; 620 and 915mm
- Non-dimmable luminaire

MOUNTING

Surface, Wall

APPLICATION AREAS

Indoor, Commercial, Residential, Retail, Hospitality

TECHNICAL DATA

LBLBL04

LAMP	LED
TOTAL POWER (W)	12 / 18W
SYSTEM OUTPUT (LM)	540 / 810LM
CCT (K)	3000 / 4000K
OPERATING VOLTAGE-VAC	220-240V
LENGTHS	620 / 915mm
DIMENSIONS	H:40 x W:80mm



LBLBL05

BATHROOM WALL LIGHTS

WALL - ART & MIRROR LIGHTING - LBLBL05

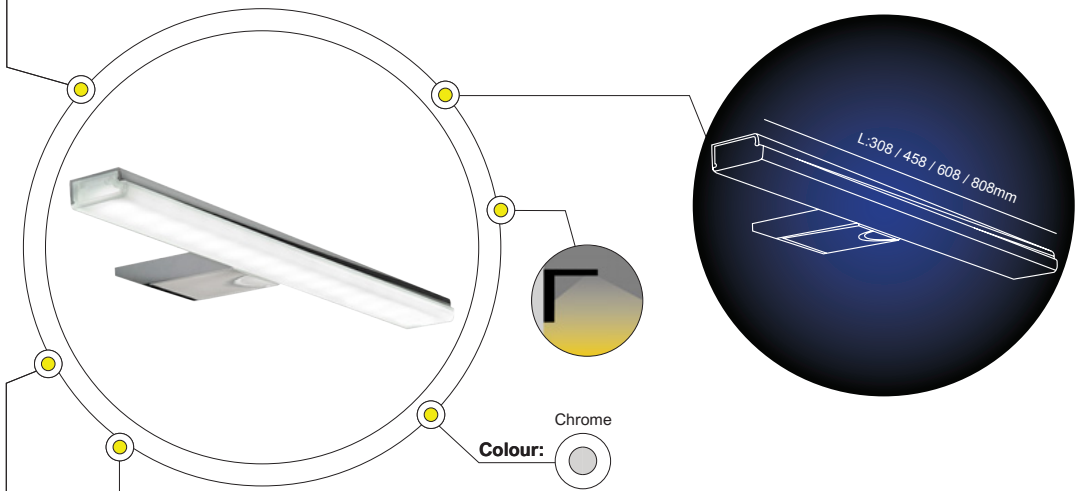

+ IP 44



5 YRS

PHYSICAL DATA

FEATURES

- Body: Aluminium, ABS with polycarbonate diffuser
- This luminaire combines a sleek design and next-generation materials
- It offers high illuminance with optimum lighting quality in the mirror and is ideal for installation over cabinets, wooden frames and mirrors
- Alternating current LED technology, Low environmental impact, No external driver, No LED spares and easy installation

OPTIONS & ACCESSORIES

- The LBLBL05 offers the following sizes: 308mm, 458mm, 606mm and 808mm for selection
- The following options are available for selection: LBLBL05 BLACK (308 and 458mm) The LBLBL05 PLUG & PLAY (458mm)

MOUNTING: Surface, Wall

APPLICATION AREAS: Indoor, Commercial, Residential, Retail, Hospitality

TECHNICAL DATA

LBLBL05

LAMP	LED
TOTAL POWER (W)	8 / 10 / 12 / 15W
SYSTEM OUTPUT (LM)	562 / 757 / 955 / 1270LM
CCT (K)	4000K / 5700K
CRI (Ra)	80
BEAM ANGLE	108°
OPERATING VOLTAGE-VAC	220-240V
RATED LIFE (HRS)	36 000HRS
LENGTH	308 / 458 / 608 / 808mm

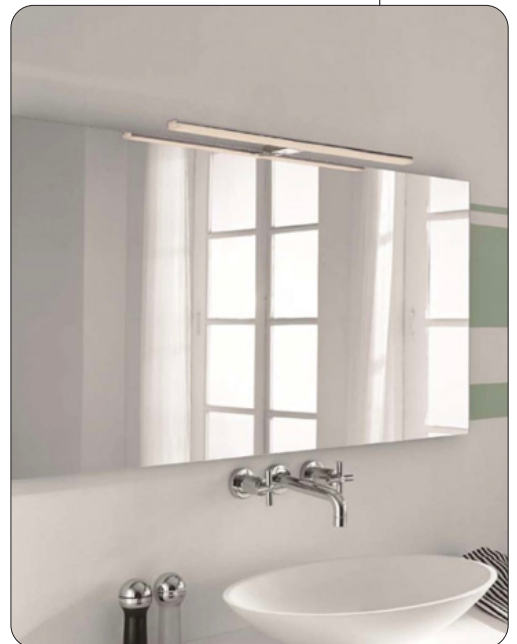

E&OE MAY OCCUR

MIRO

WALL LIGHTS

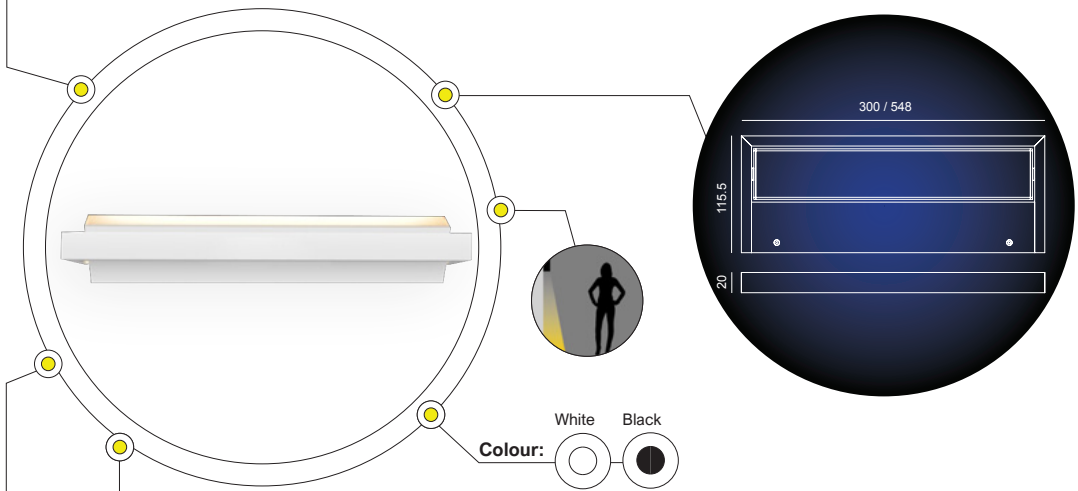

+ IP 20



LOA

3 YRS



PHYSICAL DATA

FEATURES

- Material: Aluminium
- The MIRO is a wall lamp with a diffused light that can easily be adjusted as needed; be it over a mirror, painting or other objects on a wall
- Adjustable, rotating light source - light beam can be either up or down
- Driver: On/Off

OPTIONS & ACCESSORIES

- The MIRO is available in the following lengths to choose from: 300mm or 548mm

MOUNTING

Surface

APPLICATION AREAS

Indoor, Commercial, Residential, Retail, Hospitality

TECHNICAL DATA

LF439614A

LF439714A

LAMP	LED	LED
TOTAL POWER (W)	7.7W	14.2W
SYSTEM OUTPUT (LM)	460LM	882LM
CCT (K)	3000K	3000K
CRI (Ra)	80	80
BEAM ANGLE	180°	180°
OPERATING VOLTAGE-VAC	220-240V	220-240V
SOURCE POWER (W)	9.3W	17.1W
WEIGHT (KG)	0.7KG	1.3KG
DIMENSIONS	L:300 x W:115.5 x H:20mm	L:548 x W:115.5 x H:20mm

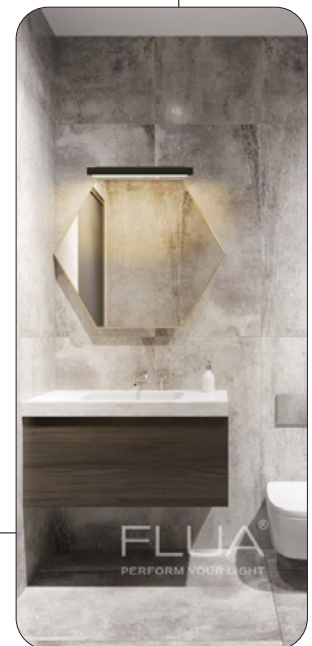
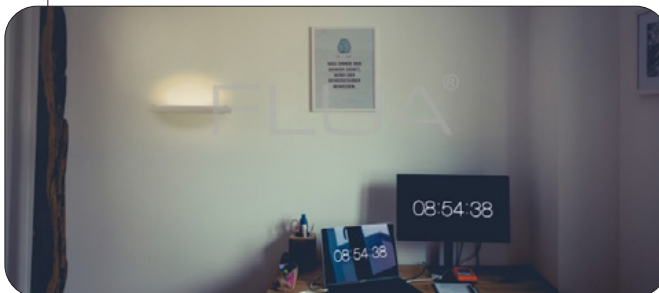

E&OE MAY OCCUR

> ILLUMINATED MIRRORS

COMMERCIAL & ARCHITECTURAL



LBLML0120

ILLUMINATED MIRROR

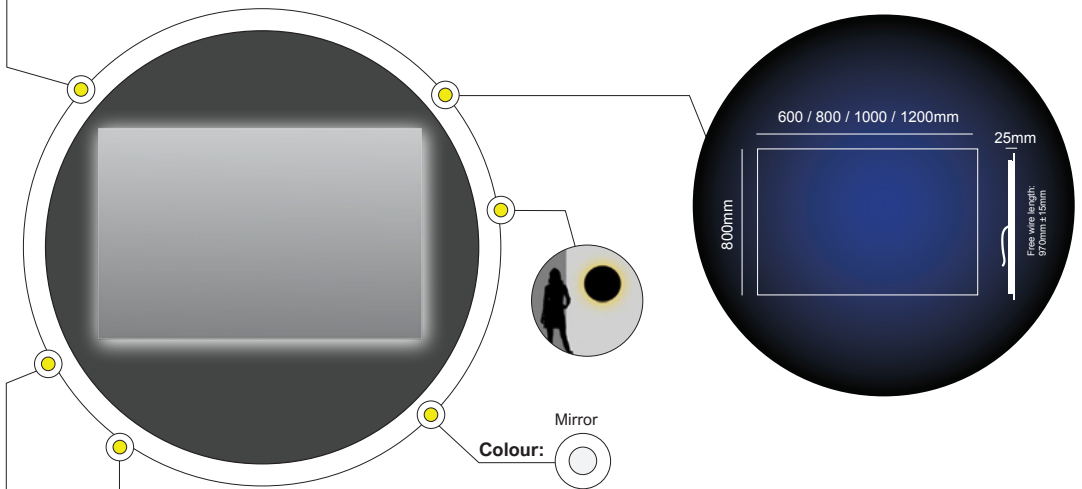

+ IP 44



5 YRS

PHYSICAL DATA

FEATURES

- Body: 4mm mirror with LED strip on PVC profile
- This illuminated mirror is an elegant mirror with pure lines that fits perfectly in any space
- This mirror has a corrosion protection treatment to avoid glass oxidation and offers medium illuminance
- The mirror can be rotated to suit your requirements
- Ambient light, easy installation and low environmental impact

OPTIONS & ACCESSORIES

- The LBLML0120 is available in the following lengths for selection 600mm, 800mm, 1000 and 1200mm

MOUNTING

Surface, Wall

APPLICATION AREAS: Indoor, Commercial, Residential, Retail, Hospitality

TECHNICAL DATA

LBLML0120

LAMP	LED
TOTAL POWER (W)	20W
SYSTEM OUTPUT (LM)	850 / 950 / 1070 / 1180LM
CCT (K)	5700K
CRI (Ra)	80
OPERATING VOLTAGE-VAC	220-240V
RATED LIFE (HRS)	36 000HRS
LENGTH	600 / 800 / 1000 / 1200mm
WIDTH	800mm

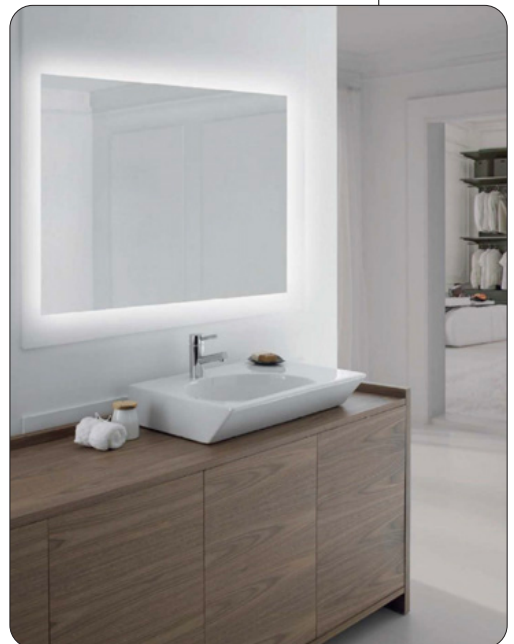

E&OE MAY OCCUR

LBLML0212

ILLUMINATED MIRROR

WALL - MIRRORS - LBLML0212

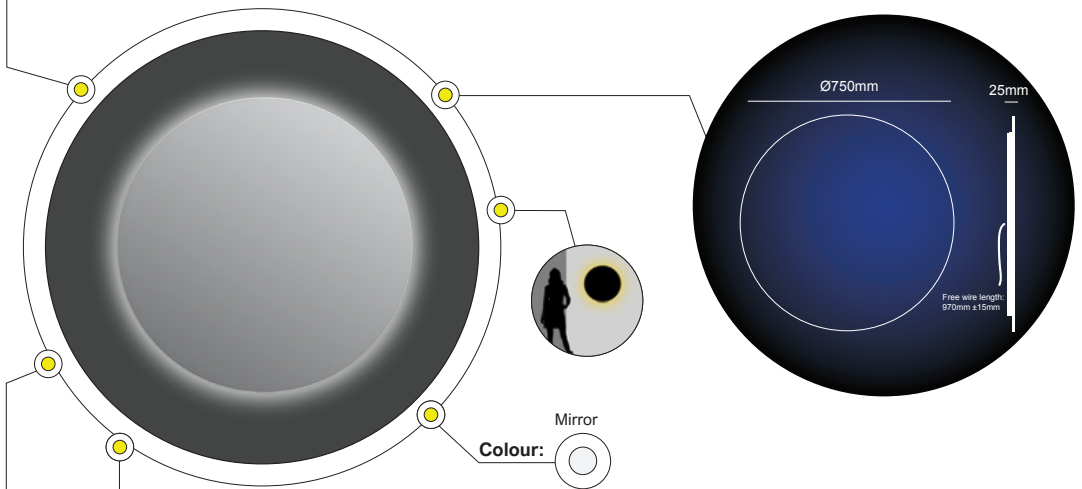

+ IP 44



5 YRS

PHYSICAL DATA

FEATURES

- Body: 4mm mirror with LED strip on PVC profile
- This illuminated mirror is an attractive mirror with a homogeneous light that offers medium illuminance
- This mirror has a corrosion protection treatment to avoid glass oxidation and a defogger system to guarantee perfect visibility without steam
- Ambient light
- Easy Installation

- Low environmental impact

MOUNTING

Surface, Wall

APPLICATION AREAS

Indoor, Commercial, Residential, Retail, Hospitality

TECHNICAL DATA

LBLML0212

LAMP	LED
TOTAL POWER (W)	12W
DEFOGGER POWER	21W
SYSTEM OUTPUT (LM)	720LM
CCT (K)	5700K
CRI (Ra)	80
OPERATING VOLTAGE-VAC	220-240V
RATED LIFE (HRS)	36 000HRS
DIAMETER	D:Ø750mm

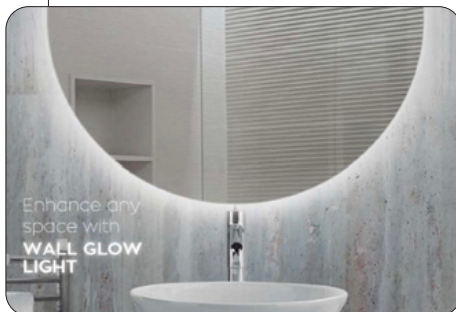

E&OE MAY OCCUR

LBLML03

ILLUMINATED MIRROR

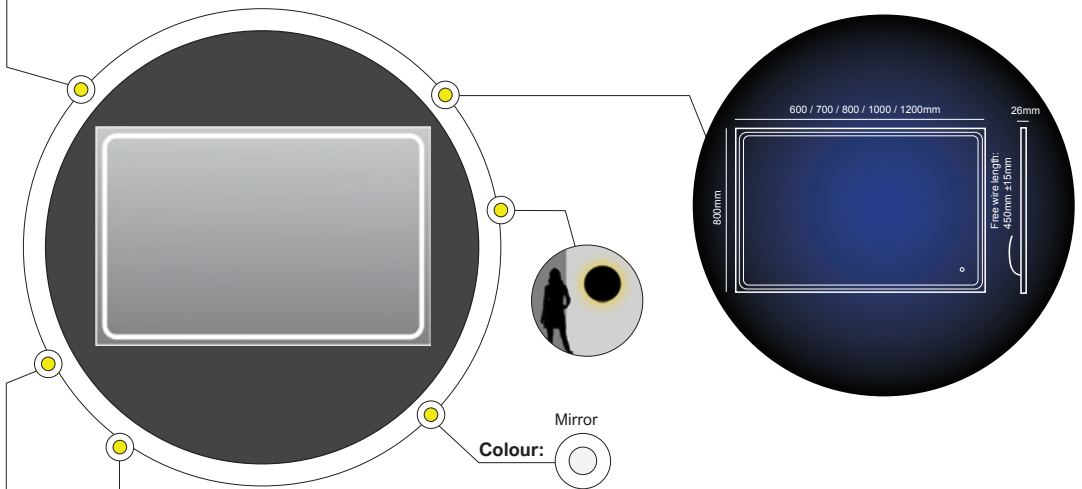

+ IP 44



5 YRS

PHYSICAL DATA

FEATURES

- Body: 4mm mirror, PVC, decorative brushed aluminium frame and LED strip
- This illuminated mirror provides optimal homogeneous lighting on the mirror with high illuminance
- The mirror has a corrosion protection treatment to avoid glass oxidation and an On/Off Touch switch
- Easy Installation and low environmental impact

OPTIONS & ACCESSORIES

- The LBLML03 is available in the following lengths for selection: 600mm, 700mm, 800mm, 1000mm and 1200mm

MOUNTING: Surface, Wall

APPLICATION AREAS

Indoor, Commercial, Residential, Retail, Hospitality

TECHNICAL DATA

LBLML03

LAMP	LED
TOTAL POWER (W)	30 / 40W
CCT (K)	5700K
CRI (Ra)	80
OPERATING VOLTAGE-VAC	220-240V
RATED LIFE (HRS)	36 000HRS
LENGTH	600 / 700 / 800 / 1000 / 1200mm
WIDTH	800mm



E&OE MAY OCCUR

LBLML0420W

ILLUMINATED MIRROR

WALL - MIRRORS - LBLML0420W

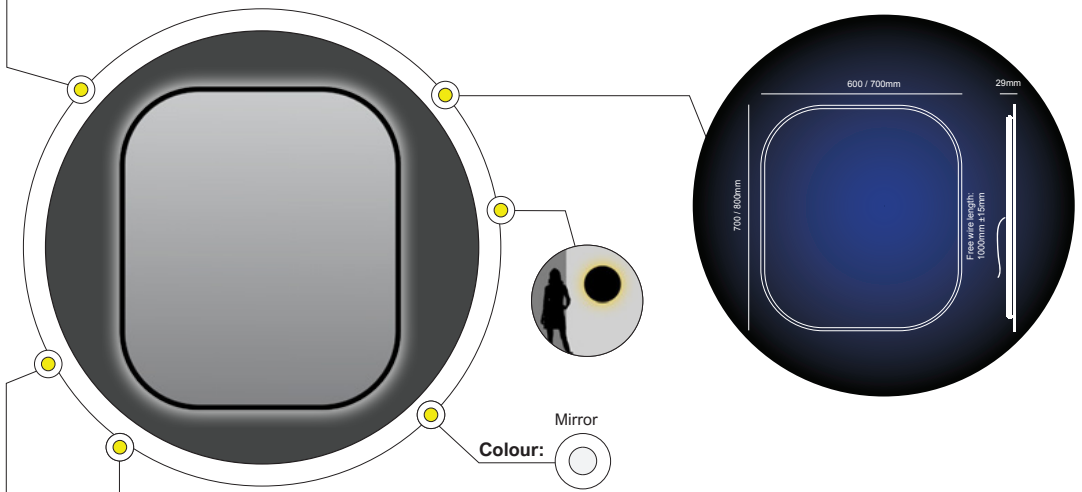

+IP 44



5 YRS

PHYSICAL DATA

FEATURES

- Body: 4mm mirror, white iron and LED strip on PVC profile
- This illuminated mirror has a decorative design with a homogeneous light that offers medium illuminance
- The mirror has a corrosion protection treatment to avoid glass oxidation
- Ambient light, easy installation and low environmental impact

OPTIONS & ACCESSORIES

- The LBLML0420W is available in the following sizes for selection: 600 x 700mm, 700 x 800mm and D:φ800mm

MOUNTING

Surface, Wall

APPLICATION AREAS

Indoor, Commercial, Residential, Retail, Hospitality

TECHNICAL DATA

LBLML0420W

LAMP	LED
TOTAL POWER (W)	20W
SYSTEM OUTPUT (LM)	820 / 945 / 890LM
CCT (K)	5700K
CRI (Ra)	80
OPERATING VOLTAGE-VAC	220-240V
RATED LIFE (HRS)	36 000HRS
DIMENSIONS	W:600 x H:700mm W:700 x H:800mm D:φ750mm



E&OE MAY OCCUR

LBLML0520

ILLUMINATED MIRROR

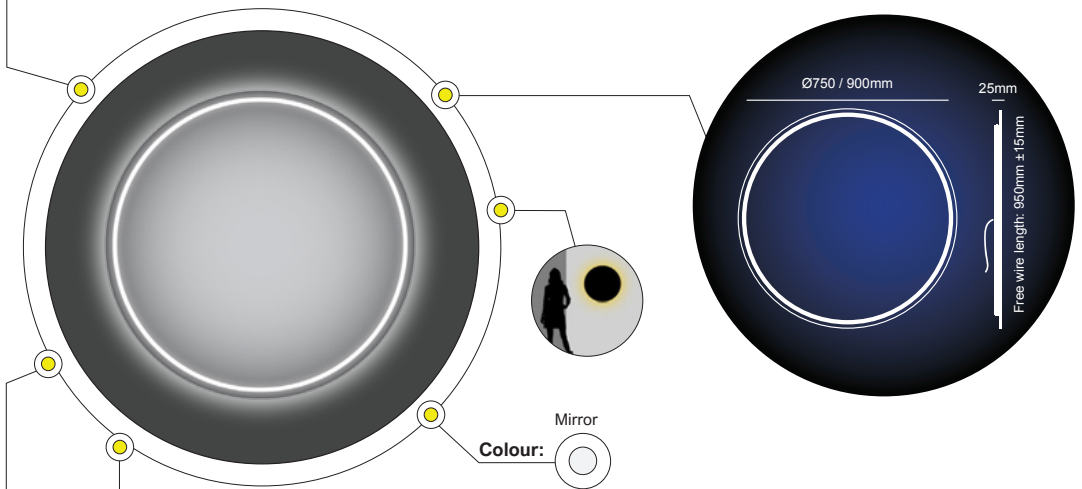

+ IP 44



5 YRS

PHYSICAL DATA

FEATURES

- Body: 4mm mirror, white iron and LED strip on PVC profile
- This illuminated mirror has an attractive round design with a homogeneous light that offers medium illuminance
- The mirror has a corrosion protection treatment to avoid glass oxidation and a defogger system to guarantee perfect visibility without steam

- Ambient light, easy Installation and low environmental impact

MOUNTING

Surface, Wall

APPLICATION AREAS

Indoor, Commercial, Residential, Retail, Hospitality

TECHNICAL DATA

LBLML0520

LAMP	LED
TOTAL POWER (W)	20W
DEFOGGER POWER	21W
SYSTEM OUTPUT (LM)	1450LM
CCT (K)	5700K
CRI (Ra)	80
OPERATING VOLTAGE-VAC	220-240V
RATED LIFE (HRS)	36 000HRS
DIAMETER	D:φ750mm

Enhance any space with
WALL GLOW LIGHT



E&OE MAY OCCUR

> BEDSIDE LIGHTING

COMMERCIAL & ARCHITECTURAL

WALL - BEDSIDE LIGHTING



Project: House Fischer / Lighting Design: Dominique Paronitti / Photography: Archigrafiya

BEL

BEDSIDE LIGHTING

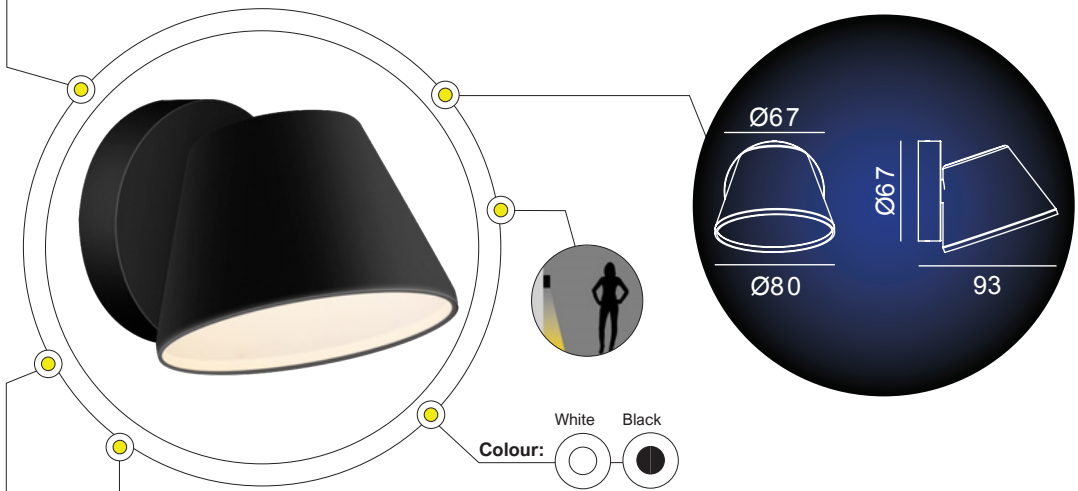

+ IP 20



LOA

3 YRS

ldt



PHYSICAL DATA

FEATURES

- Material: Aluminium
- The BEL is a classic bell/trumpet-shaped lamp that creates a vintage atmosphere. It's small and delicate frame offers a lovely soft light, making it the perfect bedside light
- TRIAC Dimming
- Adjustable, the BEL is able to rotate 350° in a clockwise/anti-clockwise direction

OPTIONS & ACCESSORIES

- Available as a single or double fixture

MOUNTING

Surface

APPLICATION AREAS

Indoor, Commercial, Residential, Retail, Hospitality

TECHNICAL DATA

LF421314DT

LAMP	LED
TOTAL POWER (W)	5W
SYSTEM OUTPUT (LM)	138LM
CCT (K)	3000K
CRI (Ra)	80
BEAM ANGLE	180°

OPERATING VOLTAGE-VAC	220-240V
DIMMING RANGE	30-100%
WEIGHT (KG)	0.16KG
SHADE DIAMETER	D:φ80mm
BASE DIAMETER	D:67mm
FITTING DEPTH	93mm



- CD / KLM
- C0 - C180
 - C90 - C270

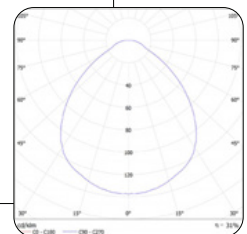

E&OE MAY OCCUR

DONNA 1

BEDSIDE LIGHTING

WALL - BEDSIDE LIGHTING - DONNA 1

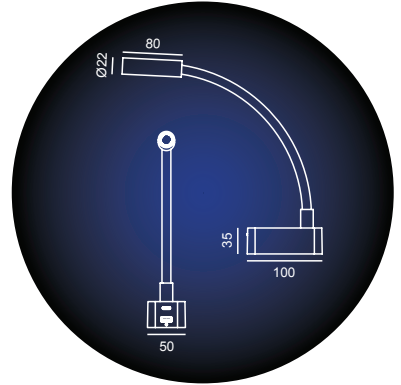
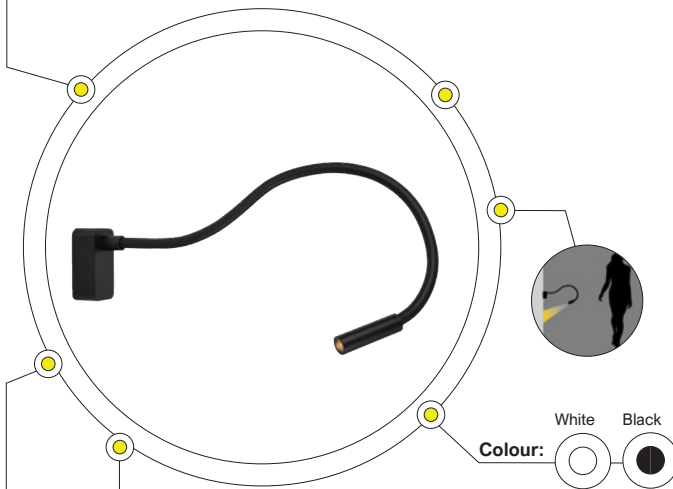

+ IP 20



LOA

2 YRS

ldt

PHYSICAL DATA

FEATURES

- Material : Aluminium
- DONNA is an example of elegance, simplicity and at the same time, usability
- This splendid reading lamp with adjustable arm and USB charging connector for IOS /Android makes it functional and useful
- Push Dimming

OPTIONS & ACCESSORIES

- The Donna 3, a 3-LED, rectangular-shaped head is available for selection

MOUNTING

Surface

APPLICATION AREAS

Indoor, Commercial, Residential, Retail, Hospitality

TECHNICAL DATA

LF428417DP

LAMP	LED
TOTAL POWER (W)	3.5W
SYSTEM OUTPUT (LM)	136LM
CCT (K)	2700 / 3000 / 4000K
CRI (Ra)	90
BEAM ANGLE	15°
OPERATING VOLTAGE-VAC	100-240V
SOURCE POWER (W)	2.2W
SOURCE LUMEN (LM)	179LM
WEIGHT	0.37KG
LIGHT DIMENSIONS	D:φ22 x L:80mm
BASE DIMENSIONS	L:100 x W:50 x H:35mm
ARM LENGTH	460mm



- CD / KLM
- C0 - C180
 - C90 - C270

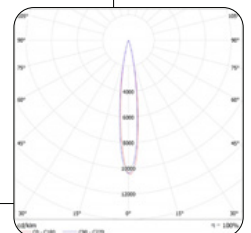

E&OE MAY OCCUR

DONNA 3

BEDSIDE LIGHTING

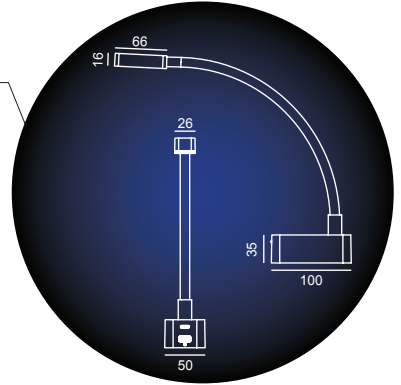
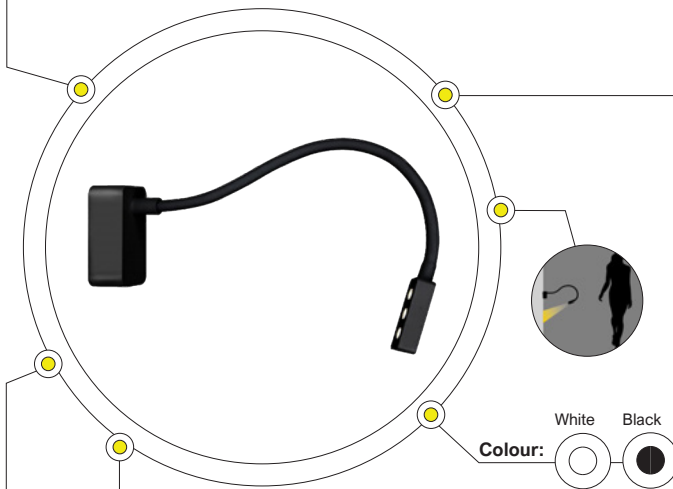

+IP 20



LOA

2 YRS

ldt

PHYSICAL DATA

FEATURES

- Material : Aluminium
- DONNA is an example of elegance, simplicity and at the same time, usability
- This splendid reading lamp with adjustable arm and USB charging connector for IOS /Android makes it functional and useful
- Push Dimming

OPTIONS & ACCESSORIES

- The Donna 1, with a single led, cylindrical-shaped head is available for selection

MOUNTING

Surface

APPLICATION AREAS

Indoor, Commercial, Residential, Retail, Hospitality

TECHNICAL DATA

LF428317DP

LAMP	LED
TOTAL POWER (W)	8.7W
SYSTEM OUTPUT (LM)	236LM
CCT (K)	3000K
CRI (Ra)	90
BEAM ANGLE	22°
OPERATING VOLTAGE-VAC	100-240V
SOURCE POWER (W)	3.2W
WEIGHT	0.51KG
LIGHT DIMENSIONS	L:66 x W:26mm x H:16mm
BASE DIMENSIONS	L:100mm x W:50mm x H:35mm

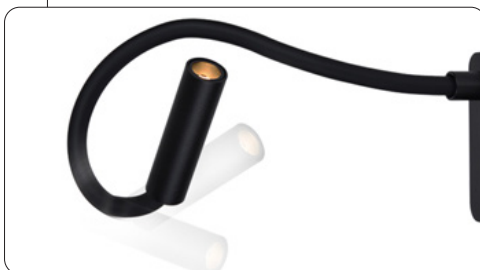

CD / KLM

● C0 - C180

● C90 - C270

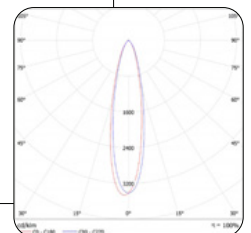

E&OE MAY OCCUR

HYPNOS IN

BEDSIDE LIGHTING

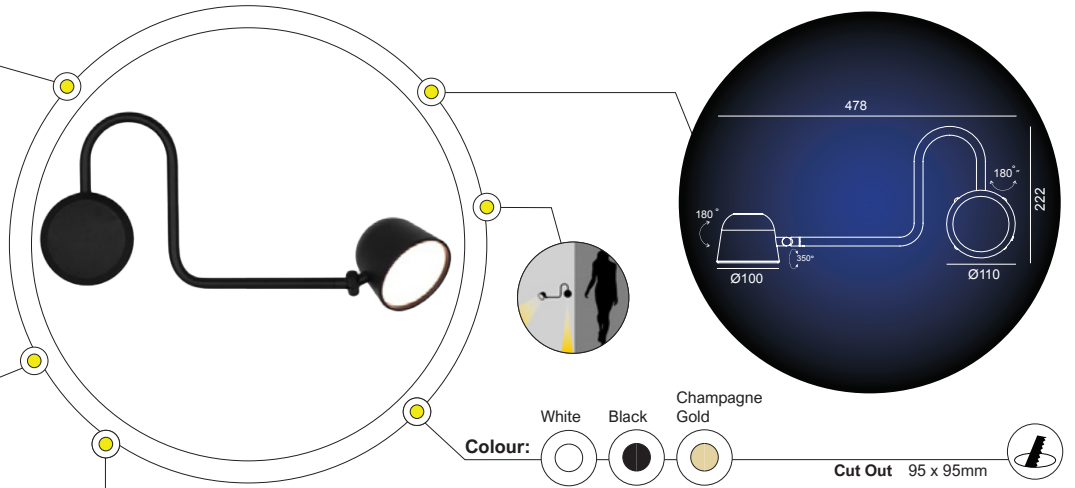

PHYSICAL DATA

FEATURES

- Material: Aluminium
- The HYPNOS has a charming industrial aesthetic. This modernist take on a retro theme delivers a unique bedside light that is simple and refreshing
- The HYPNOS is adjustable - the lamp can tilt and rotate and arm can rotate 180°
- The intimate night light, under the base, combined with the USB charging port offers functionality and

convenience

- Touch Dim function (touch-dim button on lamp head of luminaire)

MOUNTING

Recessed

APPLICATION AREAS

Indoor, Commercial, Residential, Retail, Hospitality

TECHNICAL DATA

LF4440314TD

LAMP	LED
TOTAL POWER (W)	4W + 1W
SYSTEM OUTPUT (LM)	210LM
CCT (K)	3000K
CRI (Ra)	90
BEAM ANGLE	180°
OPERATING VOLTAGE-VAC	100-240V
SOURCE POWER (W)	12W
SOURCE OUTPUT (LM)	363LM
DIMMING RANGE	10-100%
CURRENT (MA)	500MA
DIMENSIONS	D:φ100 x L:478 x H:222mm
CUT OUT	95 x 95mm

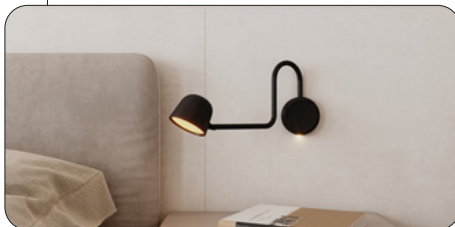
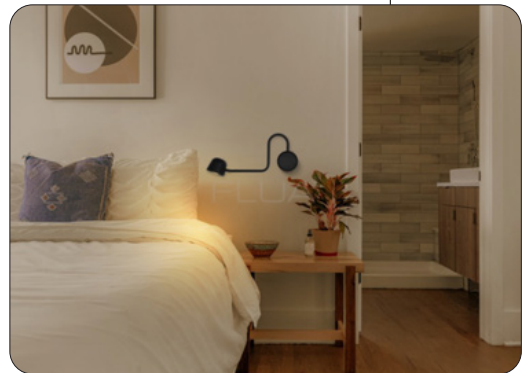

- CD / KLM
- C0 - C180
 - C90 - C270

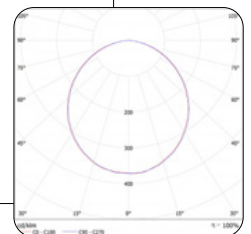

E&OE MAY OCCUR

OTLY IN ROUND

BEDSIDE LIGHTING

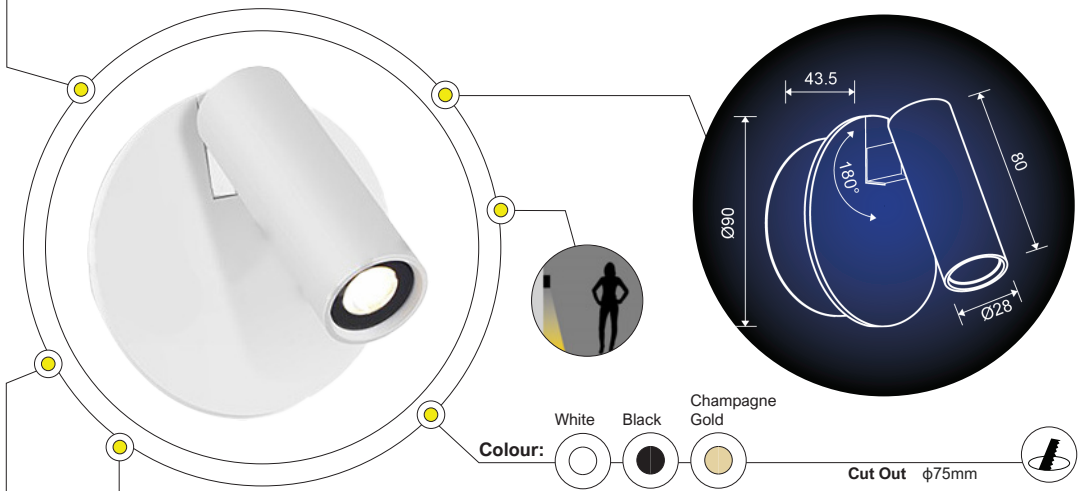

+ IP 20



LOA

5 YRS

ldt



PHYSICAL DATA

FEATURES

- Material: Aluminium
- The OTLY is a simple minimalist design
- Adjustable 180° and tilts 90°; for easy positioning of the light-beam
- Driver: On/Off

OPTIONS & ACCESSORIES

- The OTLY is available as a round or square shaped

luminaires for selection

- The OTLY SQUARE can be fitted with a switch button on request
- The OTLY IO offers a touch-dim function

MOUNTING: Recessed

APPLICATION AREAS

Indoor Commercial, Residential, Retail, Hospitality

TECHNICAL DATA

LF425117A

LAMP	LED
TOTAL POWER (W)	2.2W
SYSTEM OUTPUT (LM)	144LM
CCT (K)	3000K
CRI (Ra)	80
BEAM ANGLE	21°

OPERATING VOLTAGE-VAC	100-240V
SOURCE POWER (W)	4.5W
SOURCE OUTPUT (LM)	199LM
FLICKER FACTOR	239HZ / 2.36%
WEIGHT (KG)	0.38KG
DIMENSIONS	D:Ø90 x H:80mm
CUT OUT	D:Ø75mm

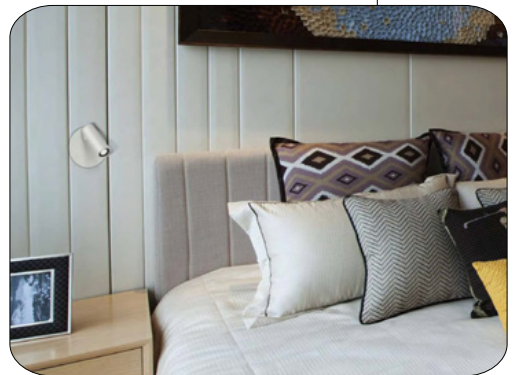

CD / KLM

- C0 - C180
- C90 - C270

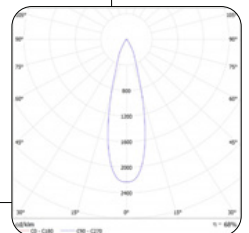

E&OE MAY OCCUR

OTLY IN SQUARE

BEDSIDE LIGHTING

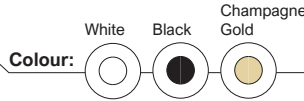
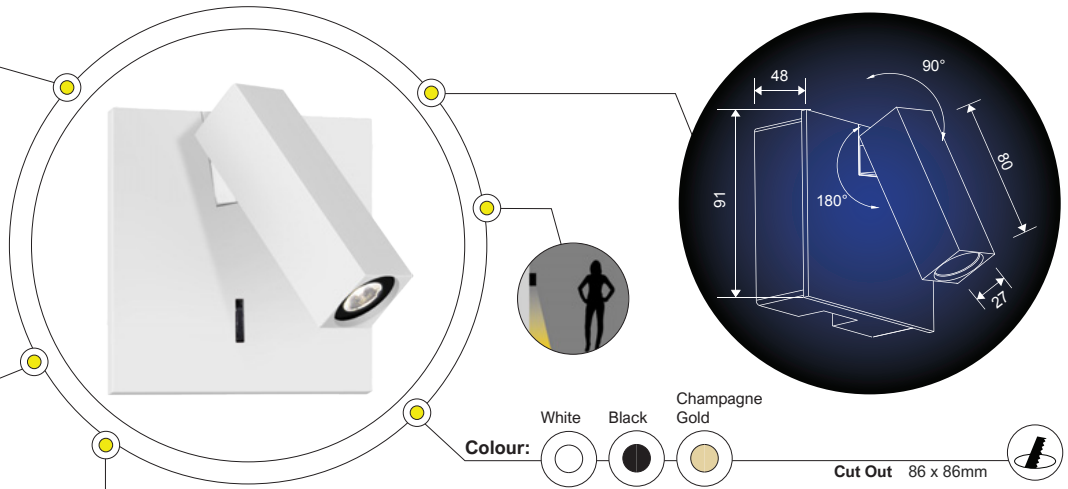

Cut Out 86 x 86mm



PHYSICAL DATA

FEATURES

- Material: Aluminium
- The OTLY is a simple minimalist design
- Adjustable, 180° for easy positioning of the light-beam
- Driver: On/Off

- The OTLY SQUARE can be fitted with a switch button on request
- The OTLY IO offers a touch-dim function

OPTIONS & ACCESSORIES

- The OTLY is available as a round or square shaped luminaires for selection

MOUNTING

Recessed

APPLICATION AREAS

Indoor Commercial, Residential, Retail, Hospitality



TECHNICAL DATA

LF425217A

LAMP	LED
TOTAL POWER (W)	2.2W
SYSTEM OUTPUT (LM)	144LM
CCT (K)	3000K
CRI (Ra)	80
BEAM ANGLE	21°
OPERATING VOLTAGE-VAC	100-240V
SOURCE POWER (W)	4.5W
SOURCE OUTPUT (LM)	199LM
FLICKER FACTOR	239HZ / 2.36%
WEIGHT (KG)	0.42KG
DIMENSIONS	D:φ90 x H:80mm
CUT OUT	86 x 86mm

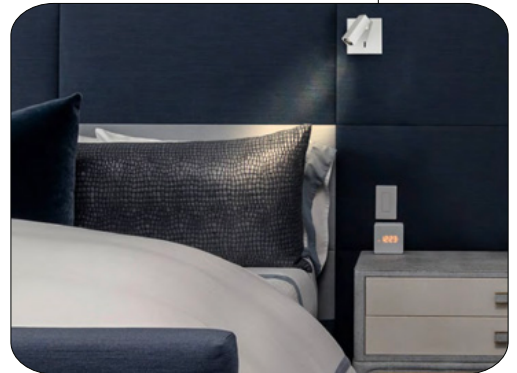

CD / KLM

C0 - C180

C90 - C270

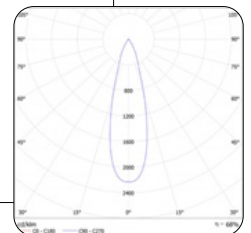

E&OE MAY OCCUR

TATOU IO BOX

BEDSIDE LIGHTING

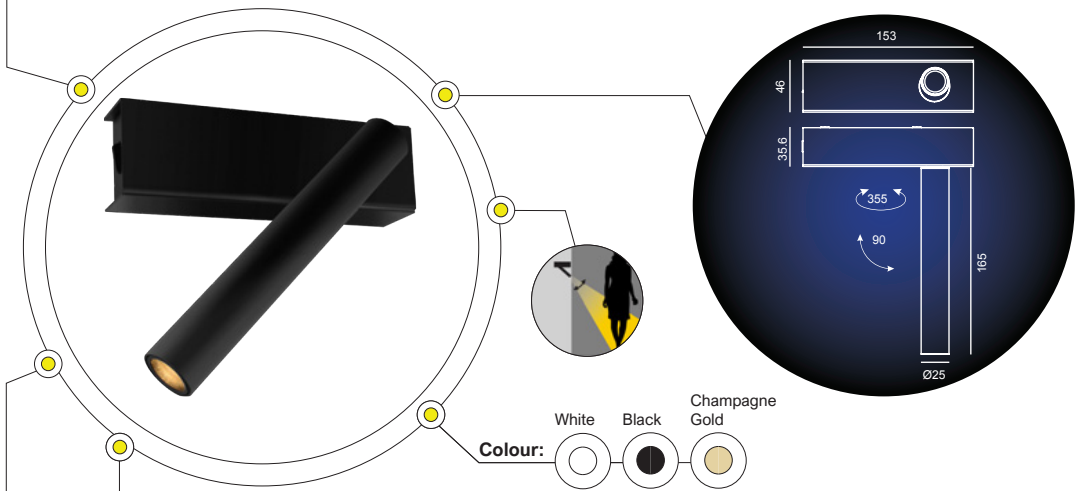

+ IP 20



LOA

5 YRS

ldt



PHYSICAL DATA

FEATURES

- Material: Aluminium
- The TATOU IO is a flexible and functional bedside lighting option. Its symmetrical design is harmonious and it's anti-glare light source makes it an ideal option for tired eyes
- Adjustable 355° and tilts 90°; for easy positioning of the light-beam
- Driver: On/Off

OPTIONS & ACCESSORIES

- The TATOU BOX is available without switch button
- The TATOU USB is available with a USB connector port

MOUNTING: Surface

APPLICATION AREAS

Indoor Commercial, Residential, Retail, Hospitality

TECHNICAL DATA

LF423111A

LAMP	LED
TOTAL POWER (W)	6W
SYSTEM OUTPUT (LM)	413LM
CCT (K)	3000K
CRI (Ra)	90
BEAM ANGLE	15°

OPERATING VOLTAGE-VAC	100-240V
SOURCE POWER (W)	7.1W
SOURCE OUTPUT (LM)	660LM
FLICKER FACTOR	789.47HZ / 3.71%
WEIGHT (KG)	0.6KG
DIMENSIONS	L:153 x W:35.6 x H:165mm

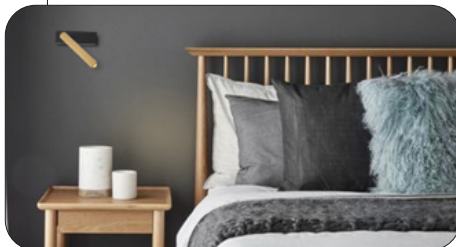
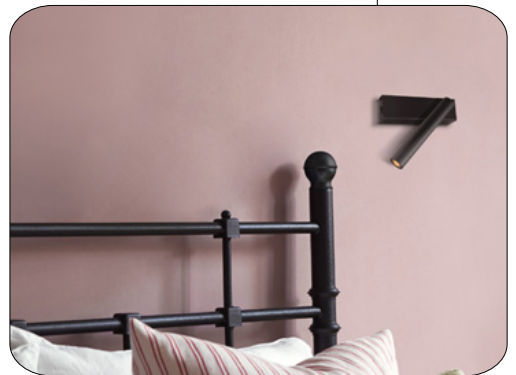

- CD / KLM
- C0 - C180
 - C90 - C270

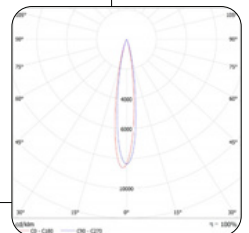

E&OE MAY OCCUR

LBLWL013

BEDSIDE LIGHTING

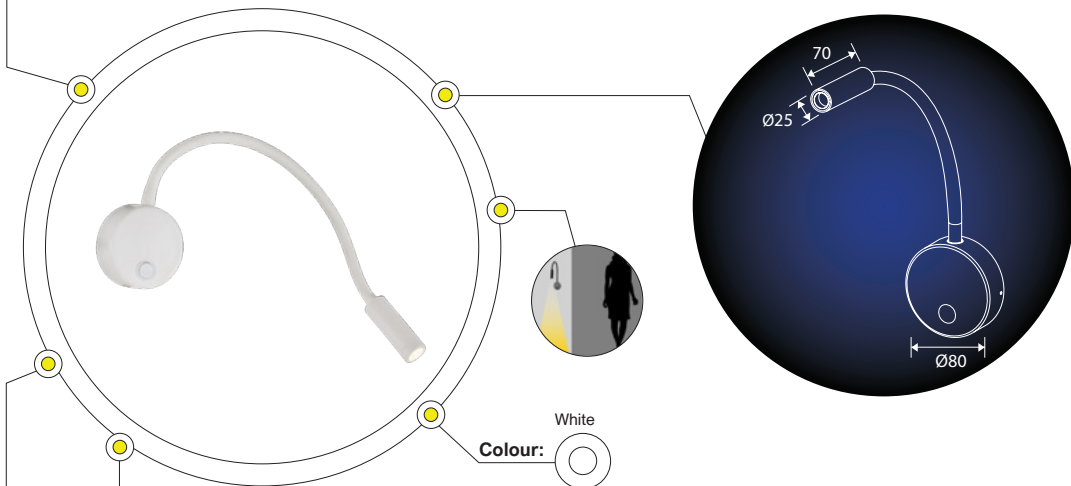

PHYSICAL DATA

FEATURES

- Material: Steel with aluminium and silicone flexi-stem
- Clear plastic lens

MOUNTING

Surface

APPLICATION AREAS

Indoor Commercial, Residential, Retail, Hospitality



TECHNICAL DATA

LBLWL013

LAMP	LED
TOTAL POWER (W)	3W
SYSTEM OUTPUT (LM)	210LM
CCT (K)	3000K
OPERATING VOLTAGE-VAC	220-240V
MOUNTING CUP	D:φ80mm
LENGTH	L:415mm
LAMP DIMENSIONS	D:φ25 x L:70mm



E&OE MAY OCCUR

> DECORATIVE WALL LIGHTS

COMMERCIAL & ARCHITECTURAL



FLUA®
PERFORM YOUR LIGHT

ADRAY RO SINGLE

WALL LIGHTS

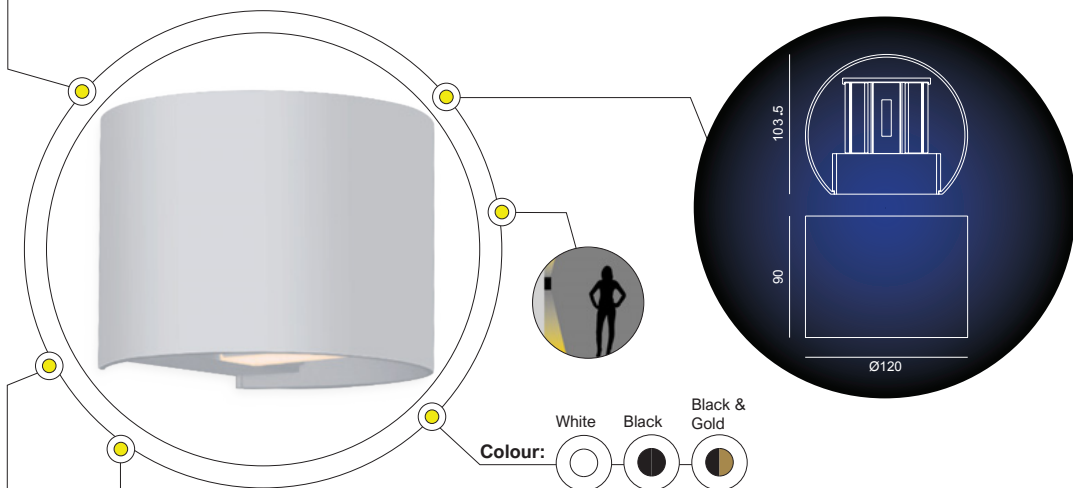

+ IP 20



LOA

5 YRS

PHYSICAL DATA

FEATURES

- Material: Aluminium
- The ADRAY is an eye-catching luminaire. It is a great example of simplicity, creativity and elegance. It has adjustable internal wings that allow one to direct the light beam angle from 0° to 90°, this makes for a dynamic and playful lighting effect in the space
- The irradiation angle can be adjusted manually
- Diver: On/Off

OPTIONS & ACCESSORIES

- The ADRAY is available in 2-shapes, round and square; with the option of single or double lamps to choose from
- TRIAC Dimmable version available for selection

MOUNTING: Surface

APPLICATION AREAS: Indoor, Commercial, Residential, Retail, Hospitality

TECHNICAL DATA

LF418419A

LAMP	LED
TOTAL POWER (W)	6.8W
SYSTEM OUTPUT (LM)	379LM
CCT (K)	3000K
CRI (Ra)	80
BEAM ANGLE	A (0°- 90°)
OPERATING VOLTAGE-VAC	100-240V
SOURCE POWER (W)	7.7W
FLICKER FACTOR	101HZ / 2.15%
WEIGHT (KG)	0.52KG
DIMENSIONS	D:φ120 x H:90mm

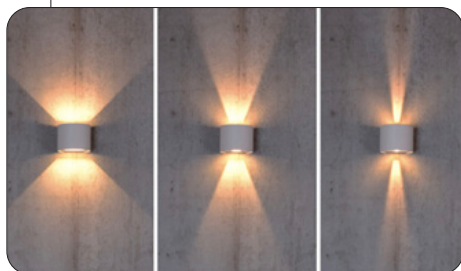

E&OE MAY OCCUR

ADRAY RO DOUBLE

WALL LIGHTS

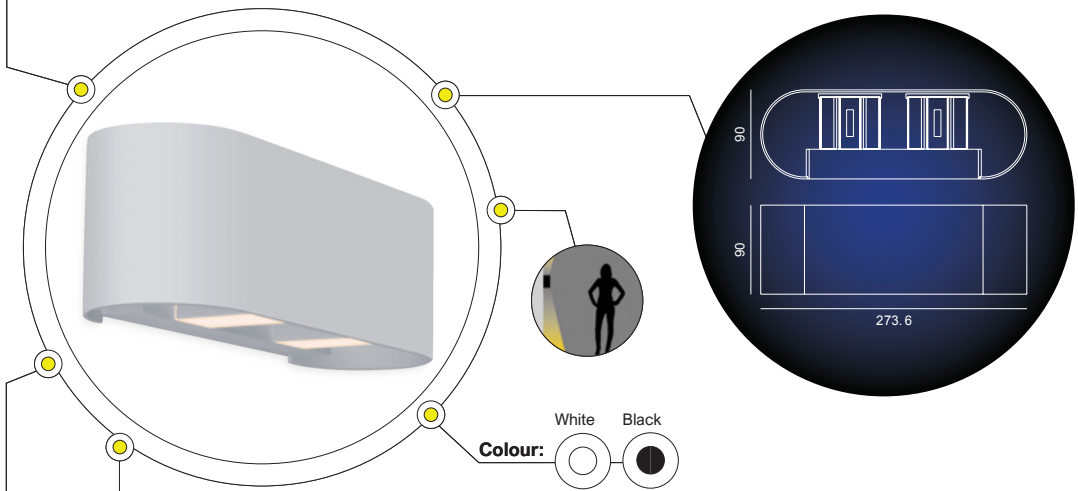

+ IP 20



LOA

3 YRS

PHYSICAL DATA

FEATURES

- Material: Aluminium
- The ADRAY is an eye-catching luminaire. It is a great example of simplicity, creativity and elegance. It has adjustable internal wings that allow one to direct the light beam angle from 0° to 90°, this makes for a dynamic and playful lighting effect in the space
- The irradiation angle can be adjusted manually
- Diver: On/Off

OPTIONS & ACCESSORIES

- The ADRAY is available in 2-shapes, round and square; with the option of single or double lamps to choose from

MOUNTING: Surface

APPLICATION AREAS

Indoor, Commercial, Residential, Retail, Hospitality

TECHNICAL DATA

LF418619A

LAMP	LED
TOTAL POWER (W)	13.6W
SYSTEM OUTPUT (LM)	1016LM
CCT (K)	3000K
CRI (Ra)	80
BEAM ANGLE	A (0°- 90°)
OPERATING VOLTAGE-VAC	220-240V
SOURCE POWER (W)	14.3W
FLICKER FACTOR	99.17HZ / 1.53%
WEIGHT (KG)	1KG
DIMENSIONS	L:273.6 x W:90 x H:90mm

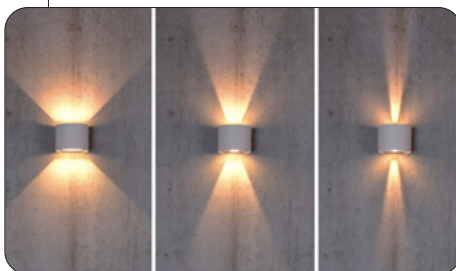

E&OE MAY OCCUR

ADRAY SQ SINGLE

WALL LIGHTS

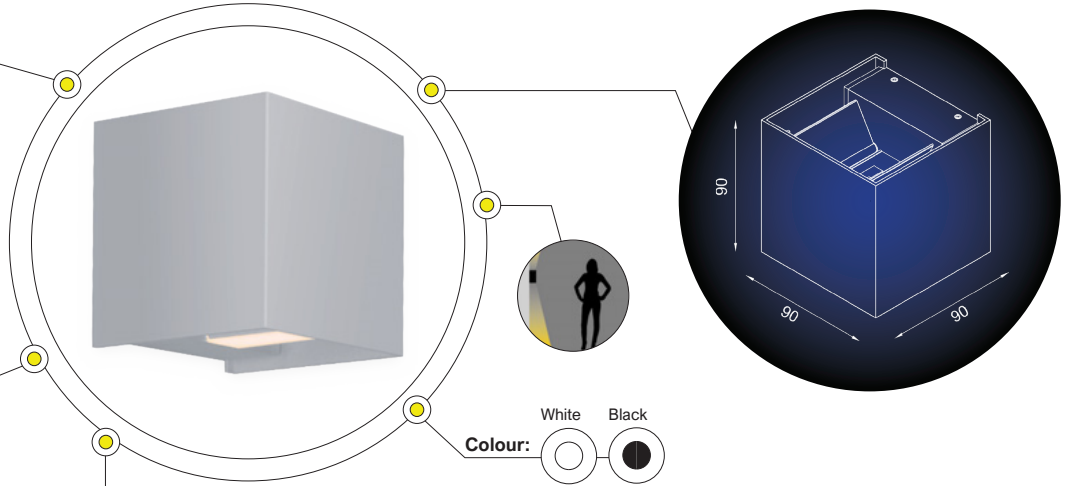

PHYSICAL DATA

FEATURES

- Material: Aluminium
- The ADRAY is an eye-catching luminaire. It is a great example of simplicity, creativity and elegance. It has adjustable internal wings that allow one to direct the light beam angle from 0° to 90°, this makes for a dynamic and playful lighting effect in the space
- The irradiation angle can be adjusted manually
- Diver: On/Off

OPTIONS & ACCESSORIES

- The ADRAY is available in 2-shapes, round and square; with the option of single or double lamps to choose from
- TRIAC Dimmable version available for selection

MOUNTING: Surface

APPLICATION AREAS

Indoor, Commercial, Residential, Retail, Hospitality

+ IP 20



LOA

3 YRS

TECHNICAL DATA

LF418319A

LAMP	LED
TOTAL POWER (W)	6.8W
SYSTEM OUTPUT (LM)	379LM
CCT (K)	3000K
CRI (Ra)	80
BEAM ANGLE	A (0°- 90°)
OPERATING VOLTAGE-VAC	100-240V
SOURCE POWER (W)	7.7W
FLICKER FACTOR	101HZ / 2.15%
WEIGHT (KG)	0.52KG
DIMENSIONS	L:90 x W:90 x H:90mm



E&OE MAY OCCUR

ADRAY SQ DOUBLE

WALL LIGHTS

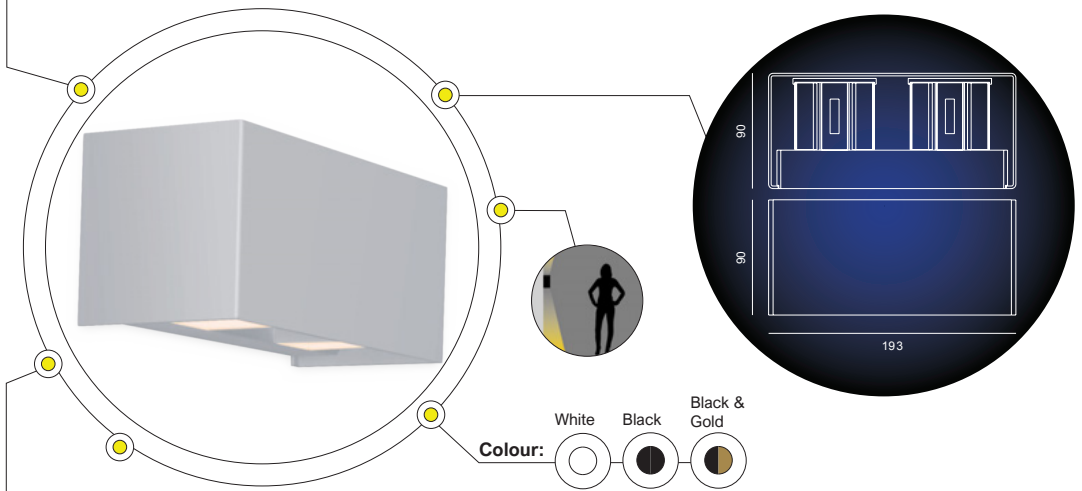

+ IP 20



LOA

3 YRS

PHYSICAL DATA

FEATURES

- Material: Aluminium
- The ADRAY is an eye-catching luminaire. It is a great example of simplicity, creativity and elegance. It has adjustable internal wings that allow one to direct the light beam angle from 0° to 90°, this makes for a dynamic and playful lighting effect in the space
- The irradiation angle can be adjusted manually
- Diver: On/Off

OPTIONS & ACCESSORIES

- The ADRAY is available in 2-shapes, round and square; with the option of single or double lamps to choose from

MOUNTING: Surface

APPLICATION AREAS

Indoor, Commercial, Residential, Retail, Hospitality

TECHNICAL DATA

LF418519A

LAMP	LED
TOTAL POWER (W)	13.6W
SYSTEM OUTPUT (LM)	1016LM
CCT (K)	3000K
CRI (Ra)	80
BEAM ANGLE	A (0°- 90°)
OPERATING VOLTAGE-VAC	220-240V
SOURCE POWER (W)	14.3W
FLICKER FACTOR	99.17HZ / 1.53%
WEIGHT (KG)	1.2KG
DIMENSIONS	L:193 x W:90 x H:90mm



E&OE MAY OCCUR

AUREOLE

WALL LIGHTS

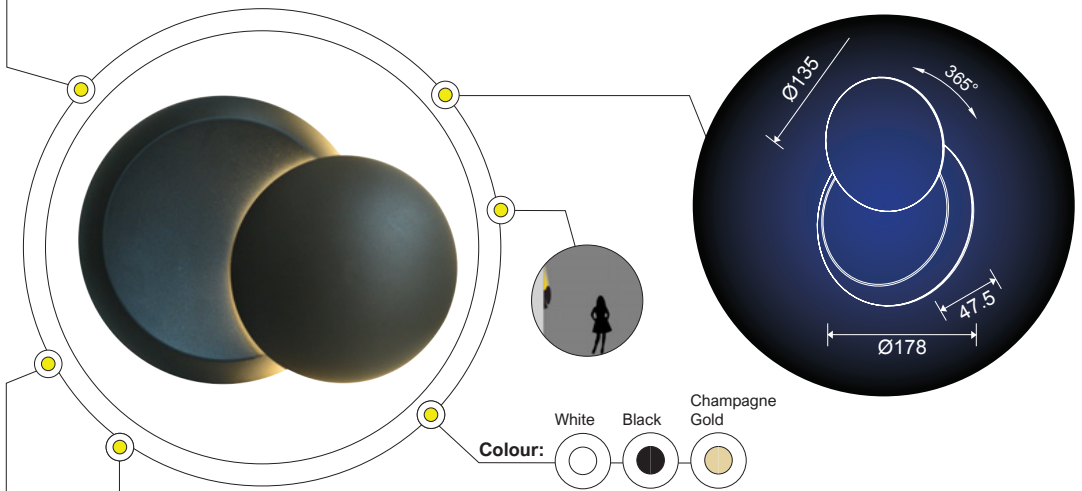

PHYSICAL DATA

FEATURES

- Material: Aluminium
- The AUREOLE, with its 355° rotational ability, is an ideal choice for auxiliary lighting
- The indirect light from this luminaire creates interesting patterns on the wall

MOUNTING

Surface

APPLICATION AREAS

Indoor, Commercial, Residential, Hospitality, Retail

+ IP 20



LOA

3 YRS



TECHNICAL DATA

LF431619A

LAMP	LED
TOTAL POWER (W)	6.5W
SYSTEM OUTPUT (LM)	216LM
CCT (K)	3000K
CRI (Ra)	90
BEAM ANGLE	180°
OPERATING VOLTAGE-VAC	220-240V
WEIGHT (KG)	1.1KG
DIMENSIONS	D:φ179 x W:47.5mm

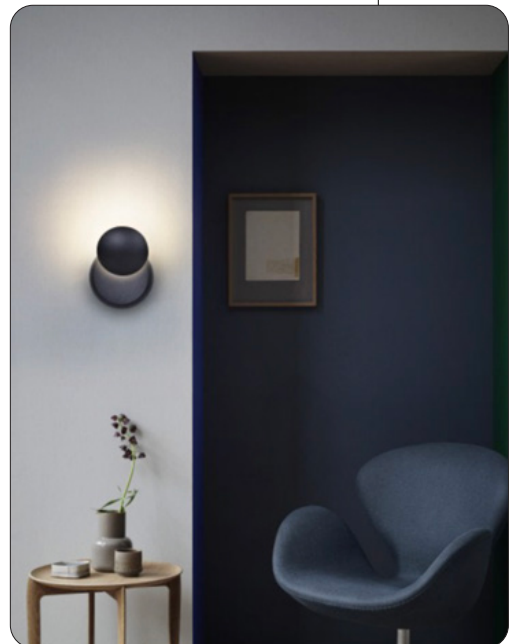
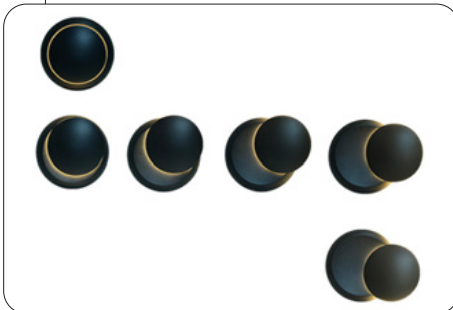

E&OE MAY OCCUR

CURES LONG

WALL LIGHTS

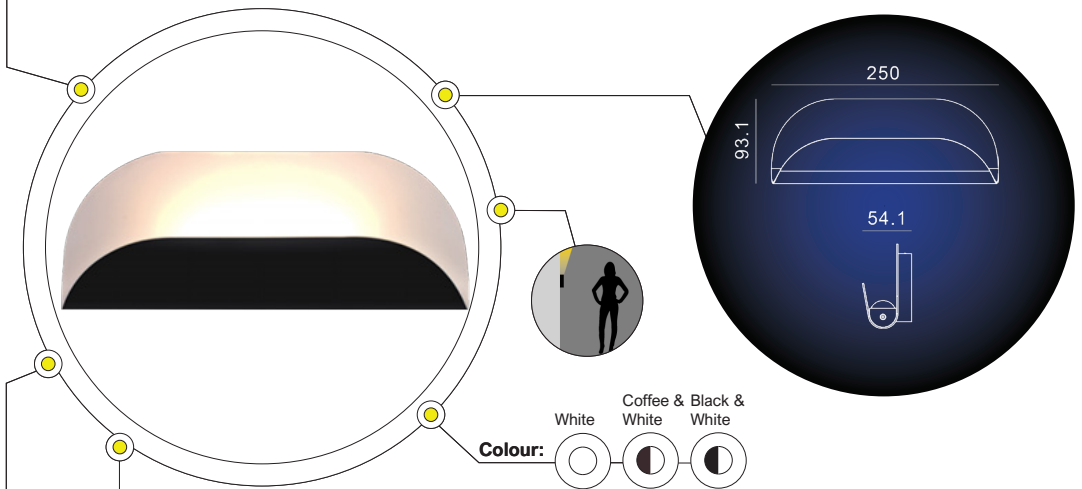

+ IP 20



LOA

3 YRS

PHYSICAL DATA

FEATURES

- Material : Aluminium
- The CURES is an origami inspired wall light, thin as paper with a slightly curved side
- Unique elegant design
- Soft-light

MOUNTING

Surface

APPLICATION AREAS

Indoor, Commercial, Residential, Retail, Hospitality

OPTIONS & ACCESSORIES

- Cures Round available

TECHNICAL DATA

LF416119A

LAMP	LED
TOTAL POWER (W)	6.4W
SYSTEM OUTPUT (LM)	414LM
CCT (K)	3000K
CRI (Ra)	80
OPERATING VOLTAGE-VAC	220-240V
SOURCE POWER (W)	7.5W
FLICKER FACTOR	100HZ / 3.69%
WEIGHT (KG)	0.75KG
DIMENSIONS	L:250 x W:93.1 x D:54.1mm

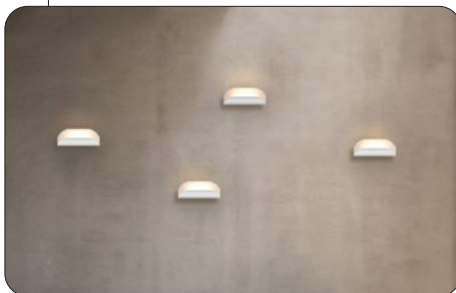

E&OE MAY OCCUR

CURES ROUND

WALL LIGHTS

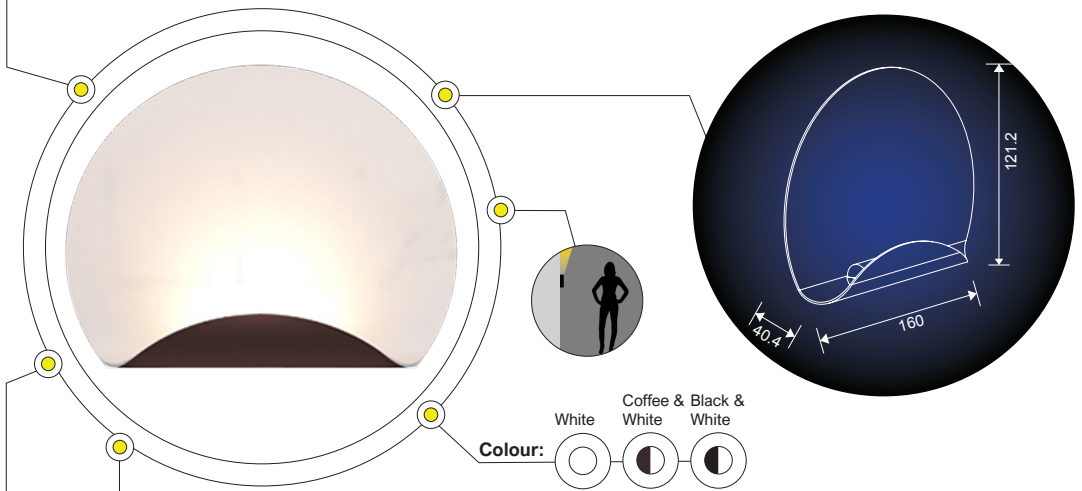

PHYSICAL DATA

+ IP 20



LOA

5 YRS

FEATURES

- Material : Aluminium
- The CURES is an origami inspired wall light, thin as paper with a slightly curved side
- Unique elegant design
- Soft-light

MOUNTING

Surface

APPLICATION AREAS

Indoor, Commercial, Residential, Retail, Hospitality

OPTIONS & ACCESSORIES

- Cures Long available

TECHNICAL DATA

LF416011A

LAMP	LED
TOTAL POWER (W)	4W
SYSTEM OUTPUT (LM)	192LM
CCT (K)	3000K
CRI (Ra)	80
OPERATING VOLTAGE-VAC	100-240V
SOURCE POWER (W)	4.6W
FLICKER FACTOR	1935.48HZ / 6.15%
WEIGHT (KG)	0.52KG
DIMENSIONS	L:160 x H:121.2 x W:40.4mm

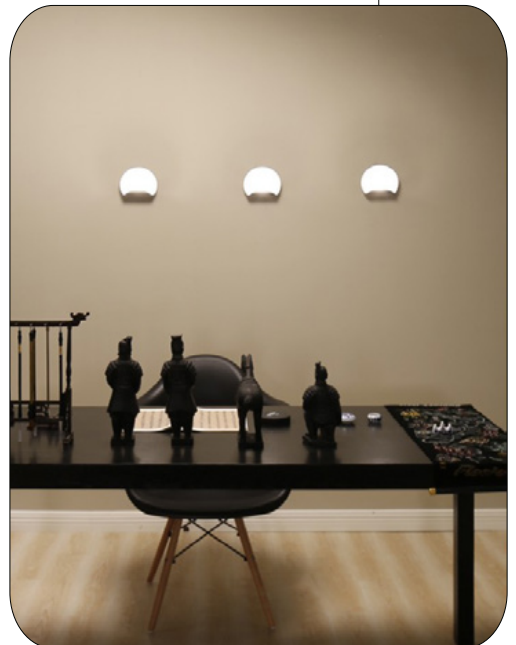

E&OE MAY OCCUR

GEMO ROUND

WALL LIGHTS

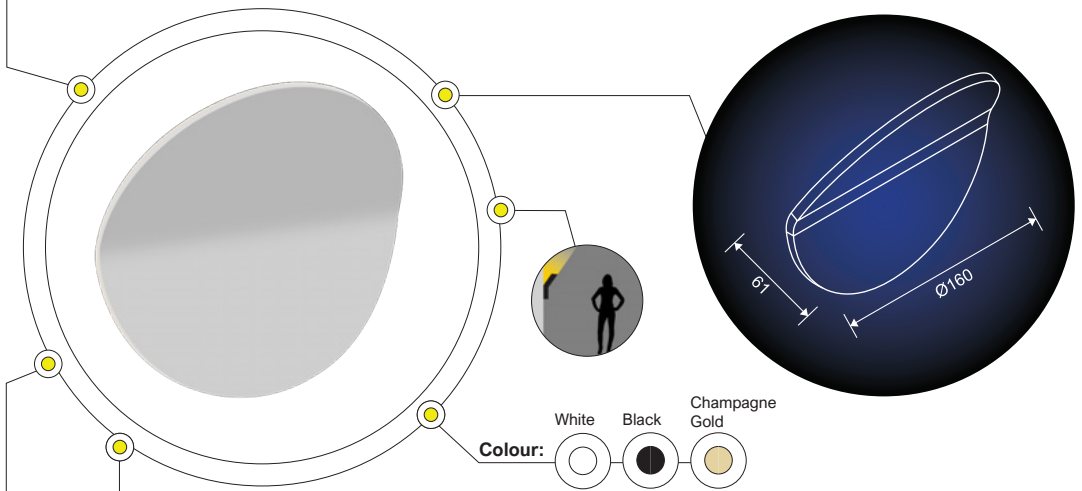

+ IP 20



LOA

3 YRS

PHYSICAL DATA

FEATURES

- Material: Stainless Steel
- The GEMO offers a simple elegant design with a decorative lighting effect
- Indirect emitting light design with bent design
- TRIAC Dimming

MOUNTING

Surface

APPLICATION AREAS

Indoor, Commercial, Residential, Retail, Hospitality

OPTIONS & ACCESSORIES

- Gemo Square available

TECHNICAL DATA

LF414415DT

LAMP	LED
TOTAL POWER (W)	3.7W
SYSTEM OUTPUT (LM)	325LM
CCT (K)	3000K
CRI (Ra)	80
BEAM ANGLE	180°
OPERATING VOLTAGE-VAC	220-240V
DIMMING RANGE	30% - 100%
WEIGHT (KG)	0.32KG
DIMENSIONS	D:φ160 x W:61mm

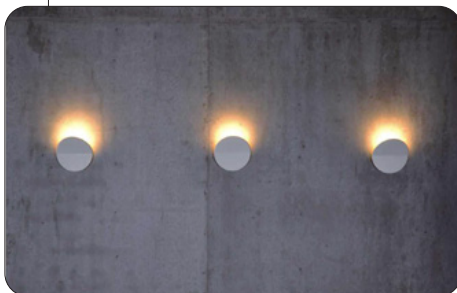

E&OE MAY OCCUR

GEMO SQUARED

WALL LIGHTS

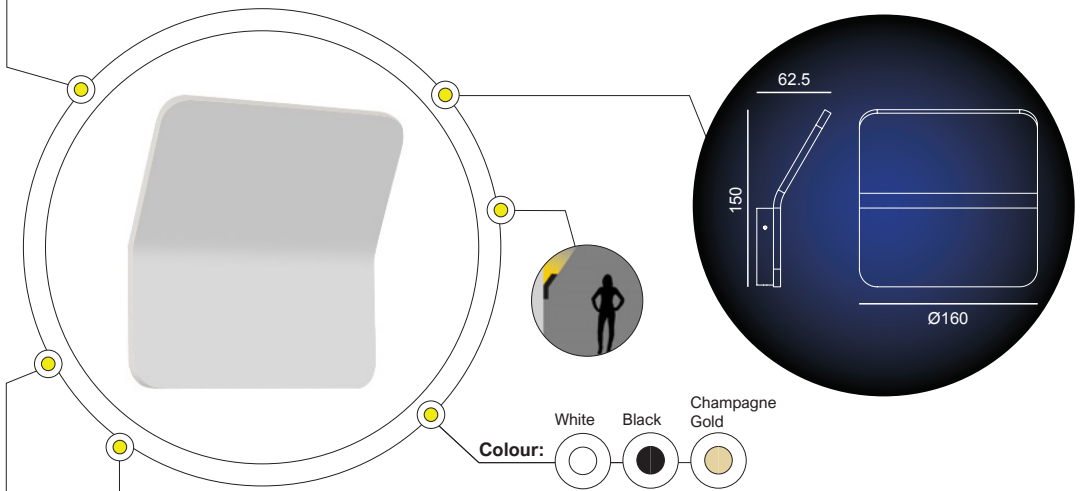

+ IP 20



LOA

3 YRS

PHYSICAL DATA

FEATURES

- Material: Stainless Steel
- The GEMO offers a simple elegant design with a decorative lighting effect
- Indirect emitting light with bent design
- TRIAC Dimming

MOUNTING

Surface

APPLICATION AREAS

Indoor, Commercial, Residential, Retail, Hospitality

OPTIONS & ACCESSORIES

- Gemo Round available

TECHNICAL DATA

LF414515DT

LAMP	LED
TOTAL POWER (W)	3.7W
SYSTEM OUTPUT (LM)	325LM
CCT (K)	3000K
CRI (Ra)	80
BEAM ANGLE	180°
OPERATING VOLTAGE-VAC	220-240V
DIMMING RANGE	30% - 100%
WEIGHT (KG)	0.38KG
DIMENSIONS	L:160 X W:62.5 x H:150mm

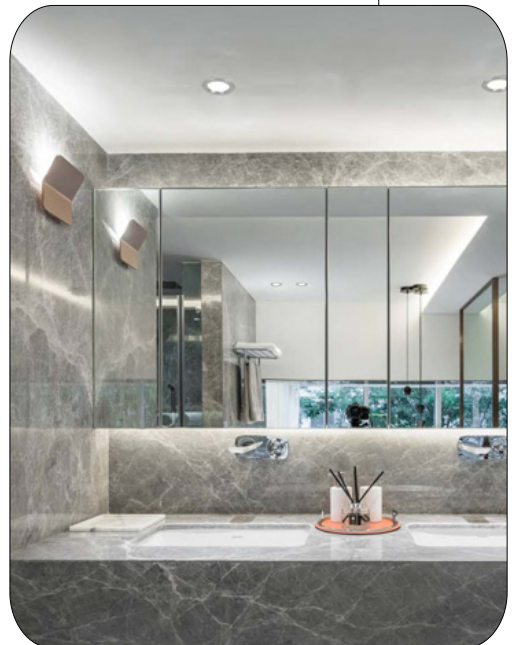
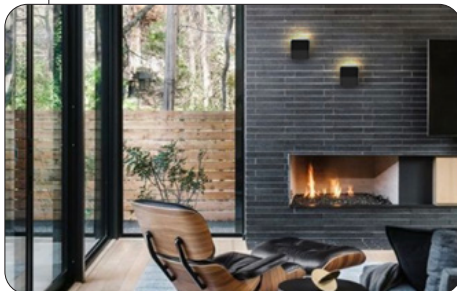

E&OE MAY OCCUR

MIRO

WALL LIGHTS

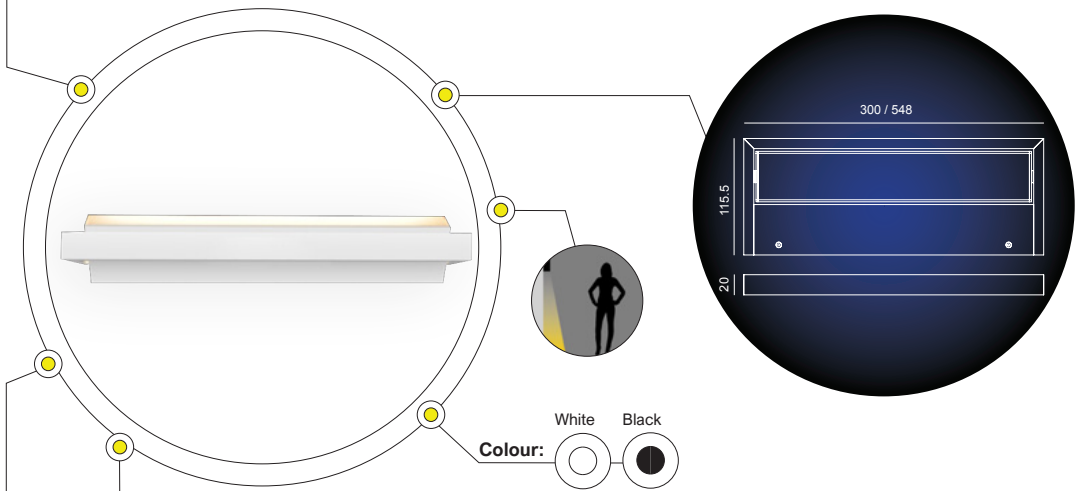

+ IP 20



LOA

3 YRS



PHYSICAL DATA

FEATURES

- Material: Aluminium
- The MIRO is a wall lamp with a diffused light that can easily be adjusted as needed; be it over a mirror, painting or other objects on a wall
- Adjustable, rotating light source - light beam can be either up or down
- Driver: On/Off

OPTIONS & ACCESSORIES

- The MIRO is available in the following lengths to choose from: 300mm or 548mm

MOUNTING

Surface

APPLICATION AREAS

Indoor, Commercial, Residential, Retail, Hospitality

TECHNICAL DATA

LF439614A

LF439714A

LAMP	LED	LED
TOTAL POWER (W)	7.7W	14.2W
SYSTEM OUTPUT (LM)	460LM	882LM
CCT (K)	3000K	3000K
CRI (Ra)	80	80
BEAM ANGLE	180°	180°
OPERATING VOLTAGE-VAC	220-240V	220-240V
SOURCE POWER (W)	9.3W	17.1W
WEIGHT (KG)	0.7KG	1.3KG
DIMENSIONS	L:300 x W:115.5 x H:20mm	L:548 x W:115.5 x H:20mm

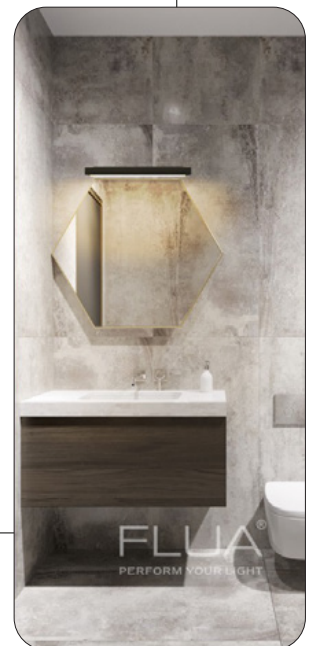
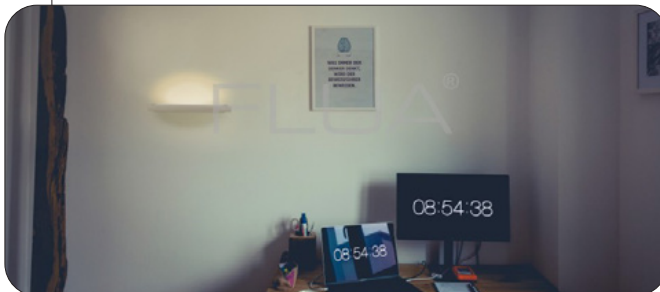

E&OE MAY OCCUR

SONG C

WALL LIGHTS

WALL - DECORATIVE WALL LIGHTS - SONG C

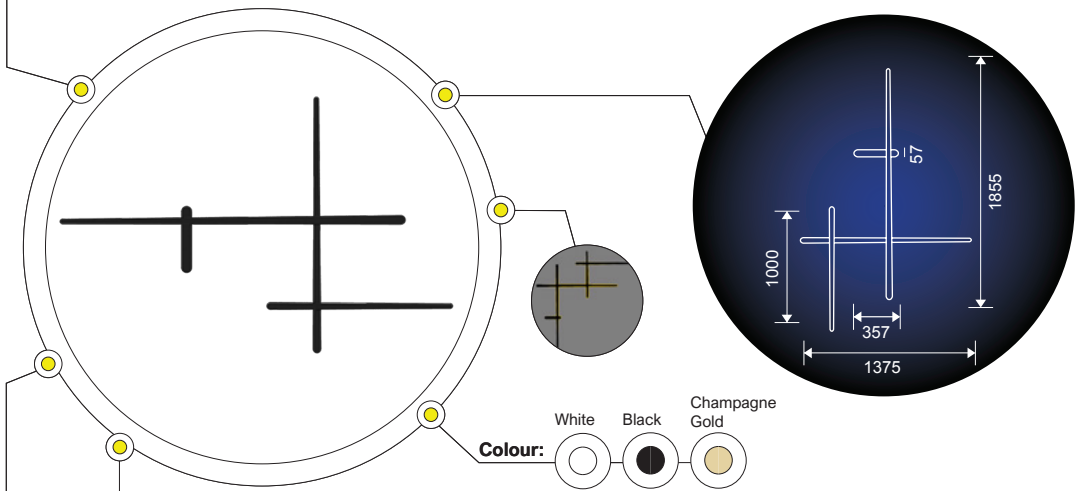

+ IP 20



LOA

3 YRS

PHYSICAL DATA

FEATURES

- Material: Aluminium
- The SONG is an example of a deep integration of light and architectural solutions
- Each element can be freely orientated and rotated in any direction endlessly creating new unique lighting inspiration
- Low-flicker, anti-glare
- 0/1-10V Dimmable only

OPTIONS & ACCESSORIES

- Available in 3 designs and sizes

MOUNTING

Surface

APPLICATION AREAS

Indoor, Commercial, Residential, Retail, Hospitality

TECHNICAL DATA

LF414034DX

LAMP	LED
TOTAL POWER (W)	29.7W
CCT (K)	3000K
CRI (Ra)	80
BEAM ANGLE	180°
OPERATING VOLTAGE-VAC	100-240V
SOURCE POWER (W)	33W
DIMMING RANGE	10-100%
FLICKER FACTOR	103.99HZ / 0.17%
WEIGHT (KG)	3.1KG
DIMENSIONS	L:1374 x H:1855mm
NUMBER OF ARMS	4

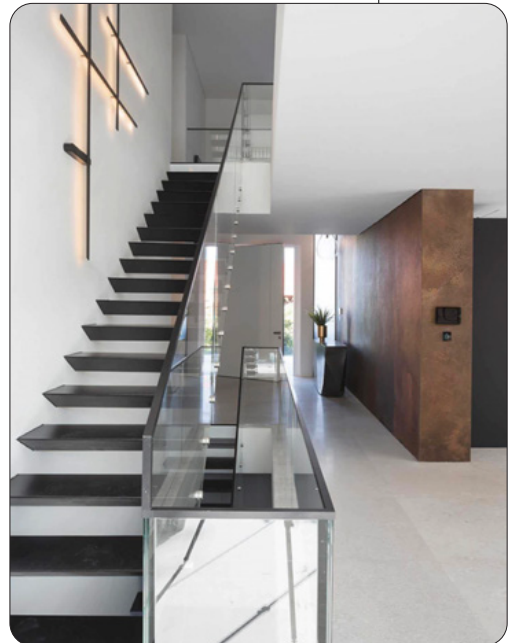
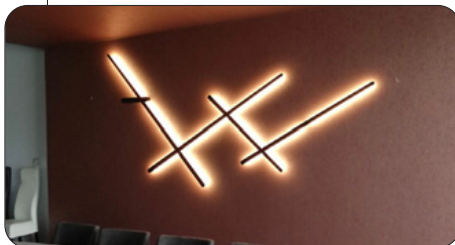

E&OE MAY OCCUR

SONG D

WALL LIGHTS

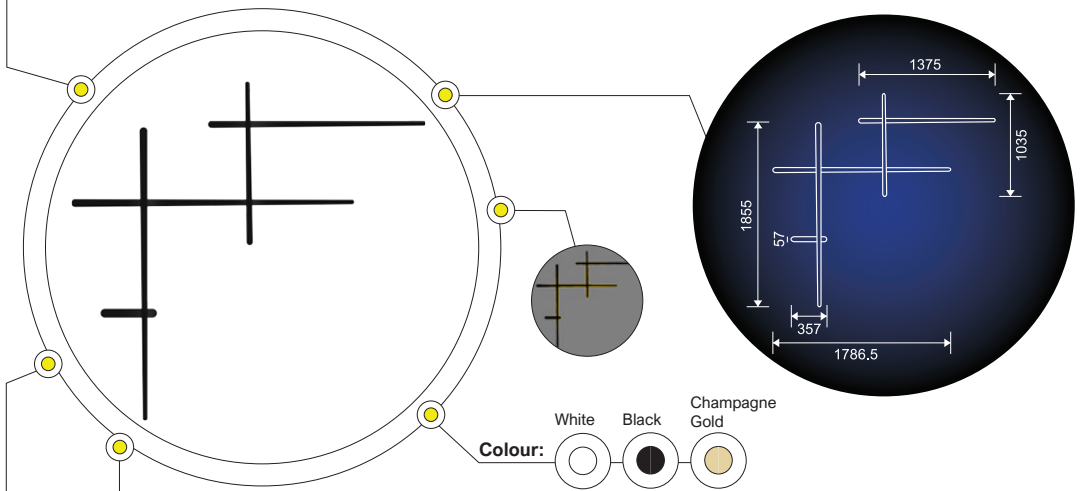

+ IP 20



LOA

3 YRS

PHYSICAL DATA

FEATURES

- Material: Aluminium
- The SONG is an example of a deep integration of light and architectural solutions
- Each element can be freely orientated and rotated in any direction endlessly creating new unique lighting inspiration
- Low-flicker, anti-glare
- 0/1-10V Dimmable only

OPTIONS & ACCESSORIES

- Available in 3 designs and sizes

MOUNTING

Surface

APPLICATION AREAS

Indoor, Commercial, Residential, Retail, Hospitality

TECHNICAL DATA

LF414144DX

LAMP	LED
TOTAL POWER (W)	42.3W
CCT (K)	3000K
CRI (Ra)	80
BEAM ANGLE	180°
OPERATING VOLTAGE-VAC	100-240V
SOURCE POWER (W)	47W
DIMMING RANGE	10-100%
WEIGHT (KG)	4KG
DIMENSIONS	H:1855 x L:1786.5 x W60mm
NUMBER OF ARMS	5

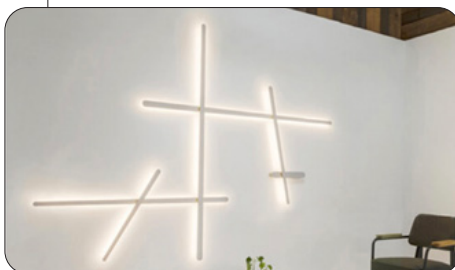

E&OE MAY OCCUR

SONG E

WALL LIGHTS

WALL - DECORATIVE WALL LIGHTS - SONG E

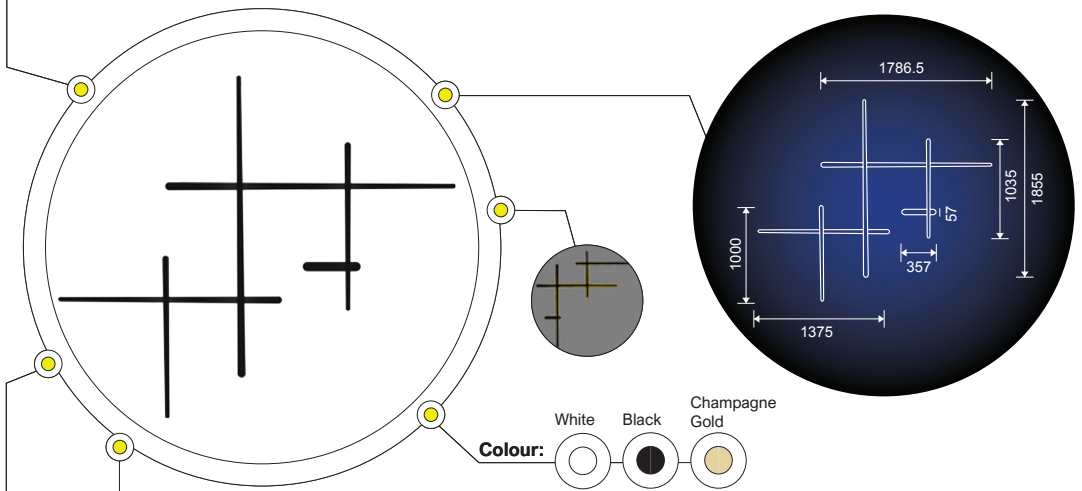

+ IP 20



LOA

3 YRS

PHYSICAL DATA

FEATURES

- Material: Aluminium
- The SONG is an example of a deep integration of light and architectural solutions
- Each element can be freely orientated and rotated in any direction endlessly creating new unique lighting inspiration
- Low-flicker, anti-glare
- 0/1-10V Dimmable only

OPTIONS & ACCESSORIES

- Available in 3 designs and sizes

MOUNTING

Surface

APPLICATION AREAS

Indoor, Commercial, Residential, Retail, Hospitality

TECHNICAL DATA

LF414254DX

LAMP	LED
TOTAL POWER (W)	48.6W
CCT (K)	3000K
CRI (Ra)	80
BEAM ANGLE	180°
OPERATING VOLTAGE-VAC	100-240V
SOURCE POWER (W)	54W
DIMMING RANGE	10-100%
WEIGHT (KG)	4KG
DIMENSIONS	H:1855 x L:1768.5 x W60mm
NUMBER OF ARMS	6

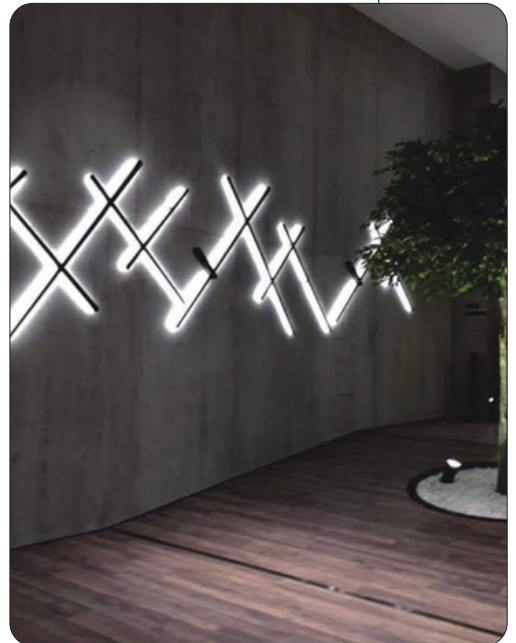

E&OE MAY OCCUR

> INDOOR FOOTLIGHTS

COMMERCIAL & ARCHITECTURAL



CARD IN1

FOOTLIGHTS

WALL - INDOOR FOOTLIGHTS - CARD IN1

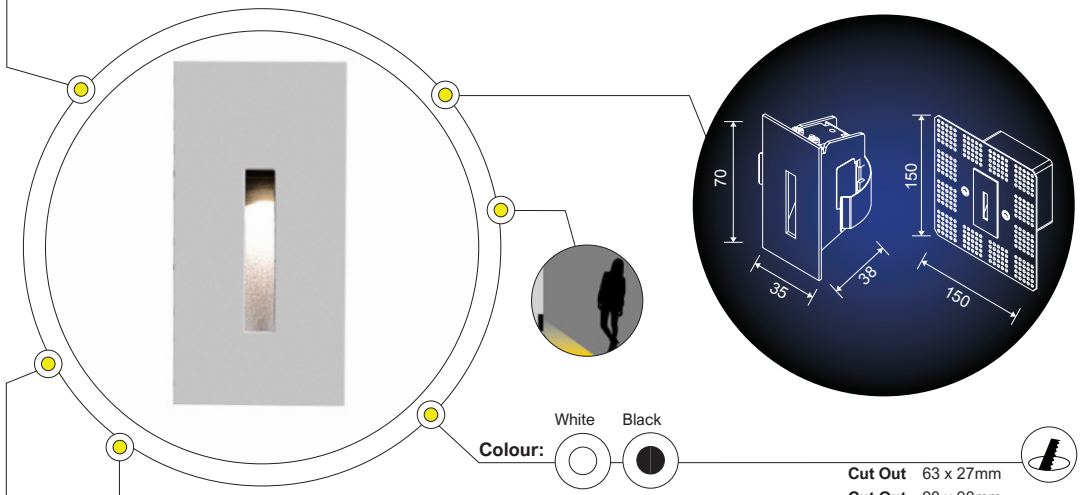

+ IP 20



LOA

5 YRS

ldt

PHYSICAL DATA

FEATURES

- Material: Aluminium
- The CARD is dedicated to indoor corridors and staircases. Its unique linear light is formed through the specific angle of the light source passing through the hole in the cover
- Trapezoid lighting effect
- Can be installed in cement and wooden walls
- Driver: On/Off

OPTIONS & ACCESSORIES

- The CARD is available in a narrow rectangular and square option for selection

MOUNTING

Recessed

APPLICATION AREAS

Indoor, Commercial, Residential, Retail, Hospitality

TECHNICAL DATA

LF419117A

LAMP	LED
TOTAL POWER (W)	2.2W
SYSTEM OUTPUT (LM)	80LM
CCT (K)	3000K
CRI (Ra)	80
OPERATING VOLTAGE-VAC	100-240V
SOURCE POWER (W)	4W
SOURCE OUTPUT (LM)	199LM
FLICKER FACTOR	243.9HZ / 2.36%
WEIGHT (KG)	0.35KG
DIMENSIONS	L:35 x W:38 x H:70mm
CUT OUT	63 x 27mm / 90 x 90mm

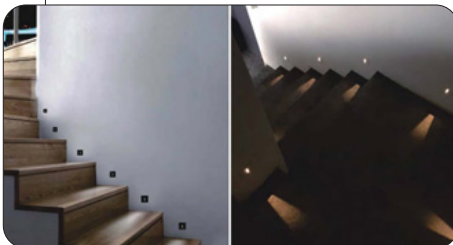

- CD / KLM
- C0 - C180
- C90 - C270

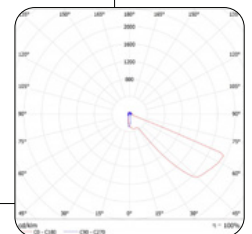

E&OE MAY OCCUR

CARD IN2

FOOTLIGHTS

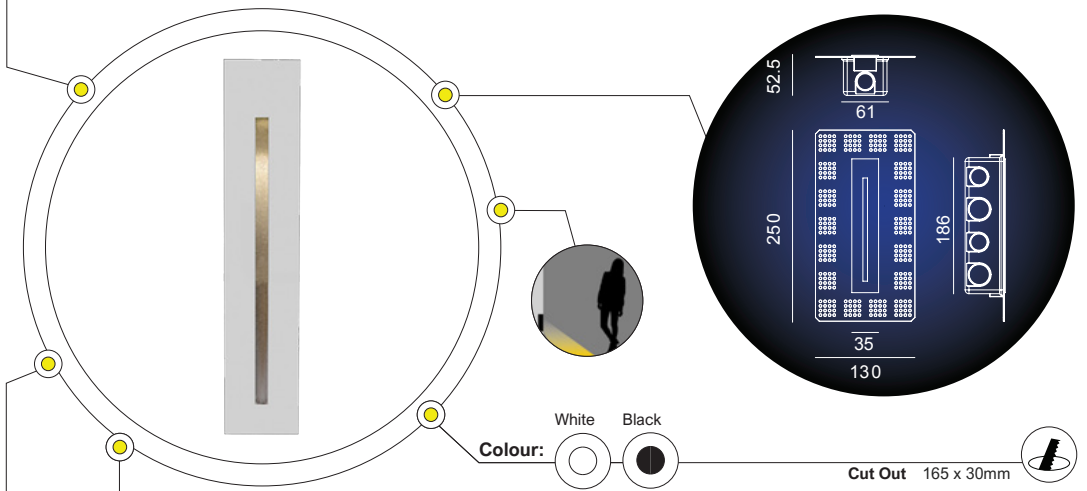

+ IP 20



LOA

5 YRS

ldt

PHYSICAL DATA

FEATURES

- Material: Aluminium
- The CARD is dedicated to indoor corridors and staircases. Its unique linear light is formed through the specific angle of the light source passing through the hole in the cover
- Trapezoid lighting effect
- Can be installed in cement and wooden walls
- Driver: On/Off

OPTIONS & ACCESSORIES

- The CARD is available in a rectangular and square option for selection

MOUNTING

Recessed

APPLICATION AREAS

Indoor, Commercial, Residential, Retail, Hospitality

TECHNICAL DATA

LF419217A

LAMP	LED
TOTAL POWER (W)	2.2W
SYSTEM OUTPUT (LM)	75LM
CCT (K)	3000K
CRI (Ra)	80
OPERATING VOLTAGE-VAC	100-240V
SOURCE POWER (W)	4W
SOURCE OUTPUT (LM)	199LM
FLICKER FACTOR	243.9HZ / 2.36%
WEIGHT (KG)	0.57KG
DIMENSIONS	L:175 x W:35 x H:70mm
CUT OUT	165 x 30mm / 190 x 65mm



CD / KLM

● C0 - C180

● C90 - C270

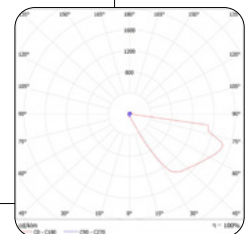

E&OE MAY OCCUR

CARD SQ

FOOTLIGHTS

WALL - INDOOR FOOTLIGHTS - CARD SQ

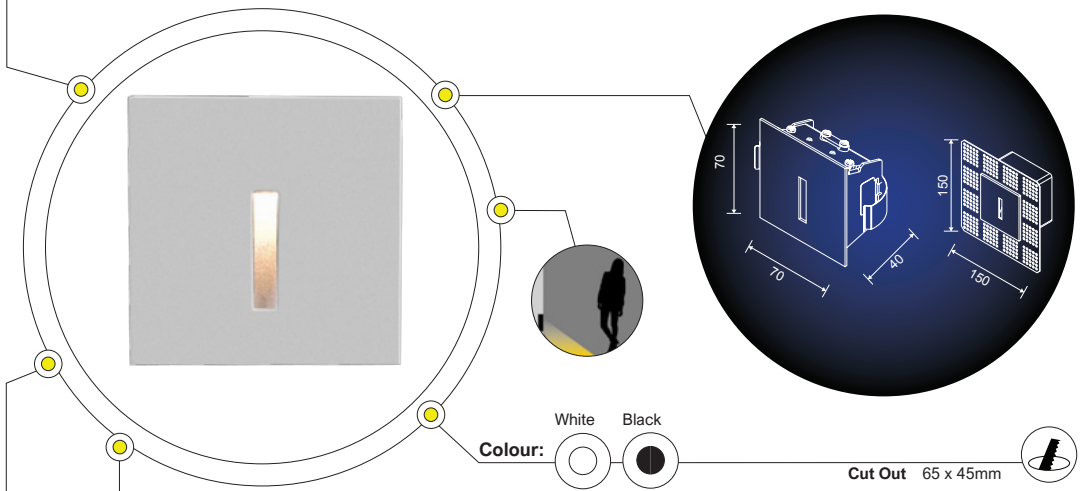

+ IP 20



LOA

5 YRS

ldt

PHYSICAL DATA

FEATURES

- Material: Aluminium
- The CARD is dedicated to indoor corridors and staircases. Its unique linear light is formed through the specific angle of the light source passing through the hole in the cover
- Trapezoid lighting effect
- Can be installed in cement and wooden walls
- Driver: On/Off

OPTIONS & ACCESSORIES

- The CARD is available in a rectangular and narrow rectangular option for selection

MOUNTING

Recessed

APPLICATION AREAS

Indoor, Commercial, Residential, Retail, Hospitality

TECHNICAL DATA

LF414917A

LAMP	LED
TOTAL POWER (W)	2.2W
SYSTEM OUTPUT (LM)	69LM
CCT (K)	3000K
CRI (Ra)	80
OPERATING VOLTAGE-VAC	100-240V
SOURCE POWER (W)	4W
SOURCE OUTPUT (LM)	199LM
FLICKER FACTOR	243.9HZ / 2.36%
WEIGHT (KG)	0.5KG
DIMENSIONS	L:70 x W:40 x H:70mm
CUT OUT	65 x 65mm / 95 x 95mm

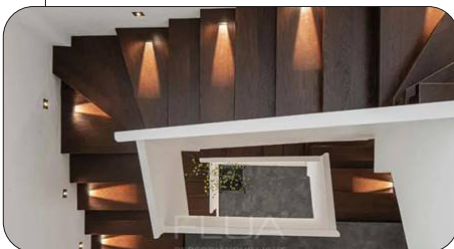

CD / KLM

● C0 - C180

● C90 - C270

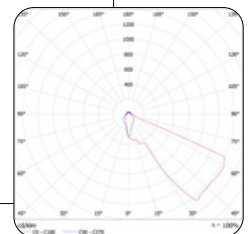

E&OE MAY OCCUR

DANAS RO 3

FOOTLIGHTS

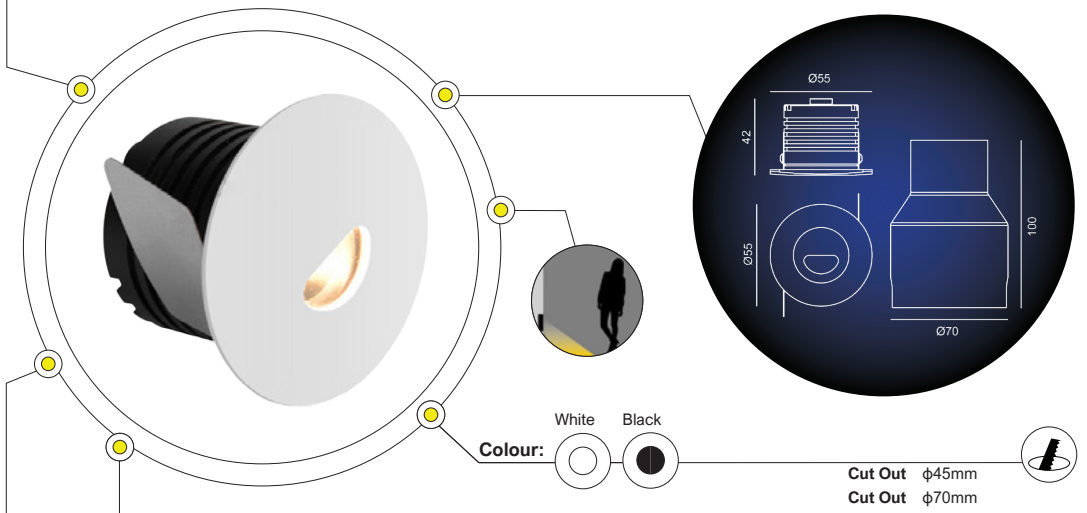

+ IP \uparrow
65



LOA

5 YRS

ldt

PHYSICAL DATA

FEATURES

- Material: Aluminium
- The DANAS comes in either a round or a square shaped options. The outer frames have a uniquely shaped holes that create unique lighting patterns on the floor
- A plastic box is provided specifically for the installation into cement walls and include mounting clips for mounting inside wooden walls

- Flexible mounting method

OPTIONS & ACCESSORIES

- Round and Square options available

MOUNTING: Recessed

APPLICATION AREAS

Indoor, Commercial, Residential, Retail, Hospitality

TECHNICAL DATA

LF408611A

LAMP	LED
TOTAL POWER (W)	2.2W
SYSTEM OUTPUT (LM)	27LM
CCT (K)	3000K
CRI (Ra)	80
OPERATING VOLTAGE-VAC	100-240V
SOURCE POWER (W)	4W
SOURCE OUTPUT (LM)	168LM
FLICKER FACTOR	1935.48HZ / 6.15%
WEIGHT (KG)	0.19KG
DIMENSIONS	D: ϕ 55 x H:42mm
CUT OUT	D: ϕ 45mm / D: ϕ 70mm

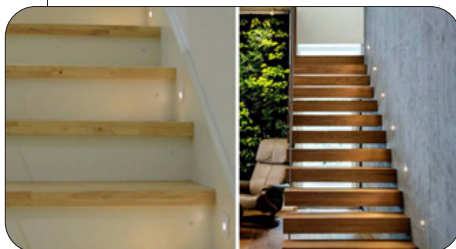
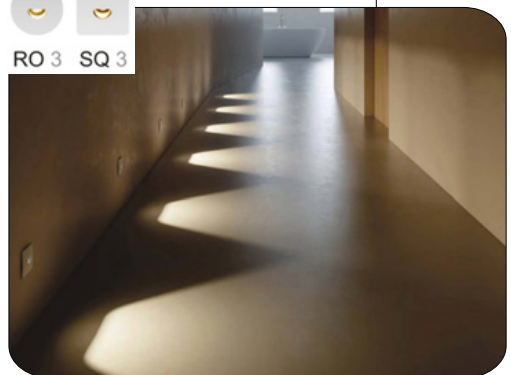

- CD / KLM
- C0 - C180
 - C90 - C270

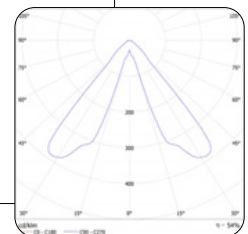

E&OE MAY OCCUR

DANAS SQ 5

FOOTLIGHTS

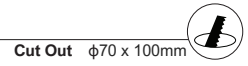
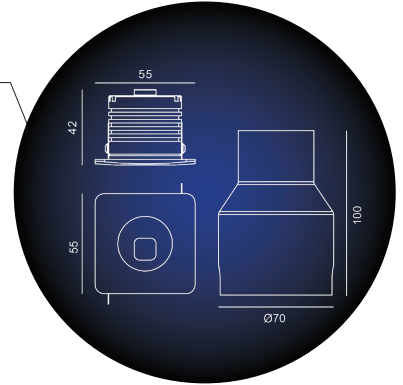
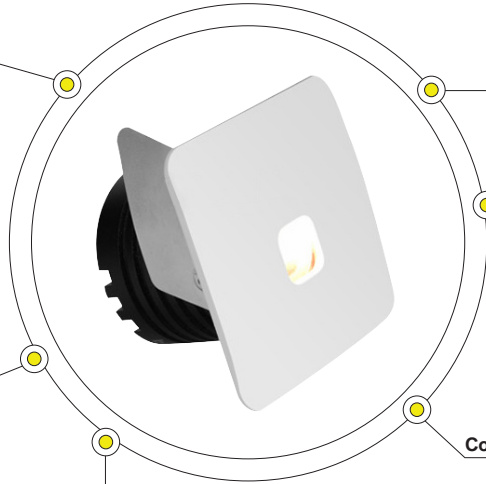

PHYSICAL DATA

FEATURES

- Material: Aluminium
- The DANAS comes in either a round or a square shaped options. The outer frames have a uniquely shaped holes that create unique lighting patterns on the floor.
- A plastic box is provided specifically for the installation into cement walls and include mounting clips for mounting inside wooden walls

- Flexible mounting method

OPTIONS & ACCESSORIES

- Round and Square options available

MOUNTING: Recessed

APPLICATION AREAS

Indoor, Commercial, Residential, Retail, Hospitality

+ IP 65



LOA

5 YRS

ldt

TECHNICAL DATA

LF409311A

LAMP	LED
TOTAL POWER (W)	2.2W
SYSTEM OUTPUT (LM)	27LM
CCT (K)	3000K
CRI (Ra)	80
BEAM ANGLE	C(63°34'-28°)
OPERATING VOLTAGE-VAC	100-240V
SOURCE POWER (W)	4W
SOURCE OUTPUT (LM)	168LM
FLICKER FACTOR	1935.48HZ / 6.15%
WEIGHT (KG)	0.61KG
DIMENSIONS	L:55 x H:55 x D:42mm
PLASTIC BACK BOX	$\phi 70 \times 100\text{mm}$

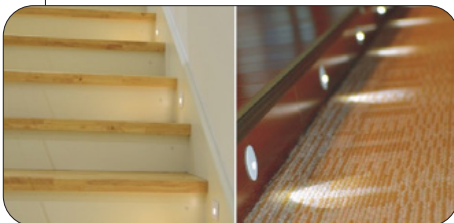
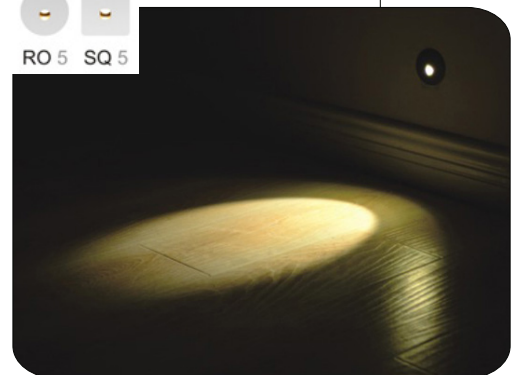

CD / KLM

C0 - C180

C90 - C270

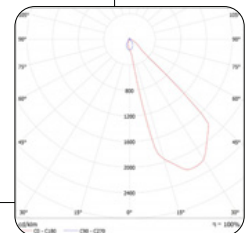

E&OE MAY OCCUR

SLIDE

FOOTLIGHTS

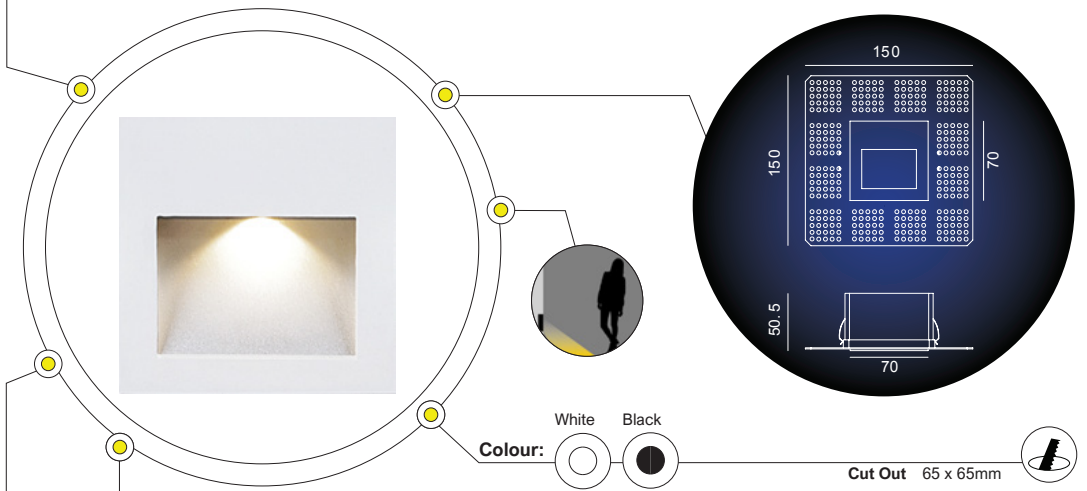

+ IP 65



LOA

5 YRS

ldt

PHYSICAL DATA

FEATURES

- Material : Aluminium
- SLIDE is a wall recessed luminaire, SLIDE is a perfect guidance light. Be it in a corridor or as a safety light for the steps at night, SLIDE does the trick

OPTIONS & ACCESSORIES

- The SLIDE is available in a square, rectangular shapes and with IP20 (non-waterproof) and IP65 (waterproof)

options for selection

- The SLIDE IP SQUARED is a stainless steel option with an IP65 waterproof rating

MOUNTING: Recessed, Wall

APPLICATION AREAS

Indoor, Outdoor, Commercial, Residential, Retail, Hospitality

TECHNICAL DATA

LF415017A

LAMP	LED
TOTAL POWER (W)	2.2W
SYSTEM OUTPUT (LM)	90LM
CCT (K)	2700 / 3000 / 3500 / 4000K
CRI (Ra)	80
OPERATING VOLTAGE-VAC	100-240V
SOURCE POWER (W)	4.2W
SOURCE OUTPUT (LM)	199LM
CURRENT (MA)	700MA
FLICKER FACTOR	1935.48HZ / 6.15%
WEIGHT (KG)	0.35KG
HOUSING DIMENSIONS	D:φ70 x H:46mm
DIMENSIONS	D:φ50 x H:36mm
CUT OUT	65 x 65mm / 95 x 95mm

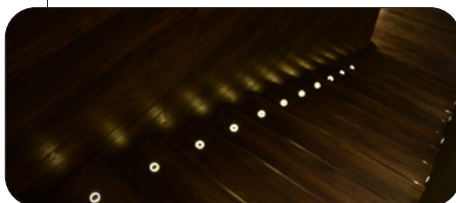
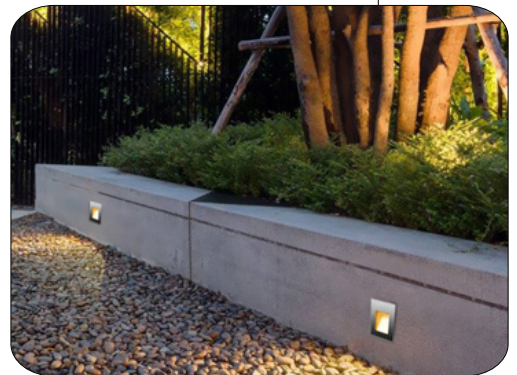

CD / KLM

C0 - C180

C90 - C270

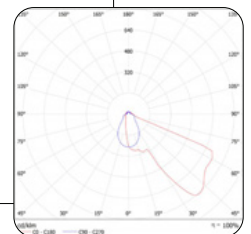

E&OE MAY OCCUR

SLIDE IP RECTANGULAR

FOOTLIGHTS

WALL - INDOOR FOOTLIGHTS - SLIDE IP RECTANGULAR

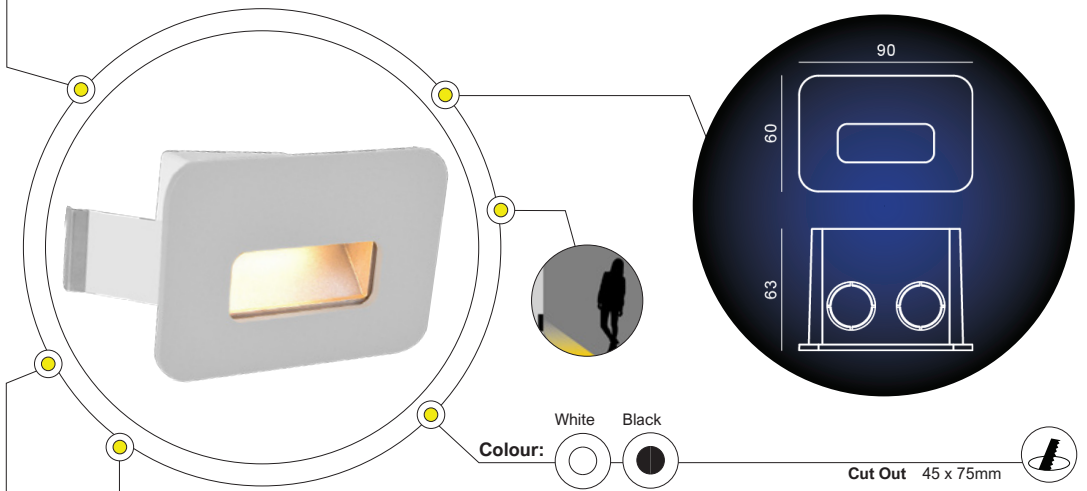

+ IP 65



LOA

5 YRS

ldt

PHYSICAL DATA

FEATURES

- Material : Aluminium
- SLIDE is a wall recessed luminaire, SLIDE is a perfect guidance light.
- Be it in a corridor or as a safety light for the steps at night, SLIDE does the trick

OPTIONS & ACCESSORIES

- The SLIDE is available in a square, rectangular shapes

- and with IP20 (non-waterproof) and IP65 (waterproof) options for selection
- The SLIDE IP AISI316 is a stainless steel option with an IP65 waterproof rating

MOUNTING: Recessed

APPLICATION AREAS: Indoor, Outdoor, Commercial, Residential, Retail, Hospitality

TECHNICAL DATA

LF411314A

LAMP	LED
TOTAL POWER (W)	3W
SYSTEM OUTPUT (LM)	171LM
CCT (K)	2700 / 3000 / 3500 / 4000K
CRI (Ra)	80

OPERATING VOLTAGE-VAC	100-240V
SOURCE POWER (W)	5.1W
SOURCE OUTPUT (LM)	380LM
CURRENT (MA)	350MA
FLICKER FACTOR	1935.48HZ / 6.15%
WEIGHT (KG)	0.24KG
DIMENSIONS	L:90 x W:63 x H:60mm
CUT OUT	L:75 x W:45mm

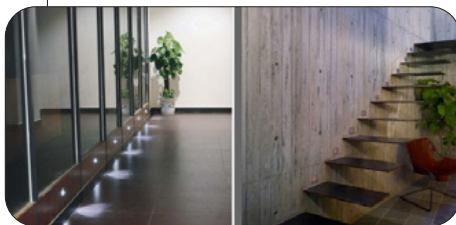

CD / KLM

● C0 - C180

● C90 - C270

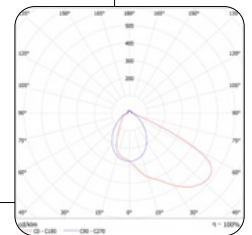

E&OE MAY OCCUR

SNOW

FOOTLIGHTS

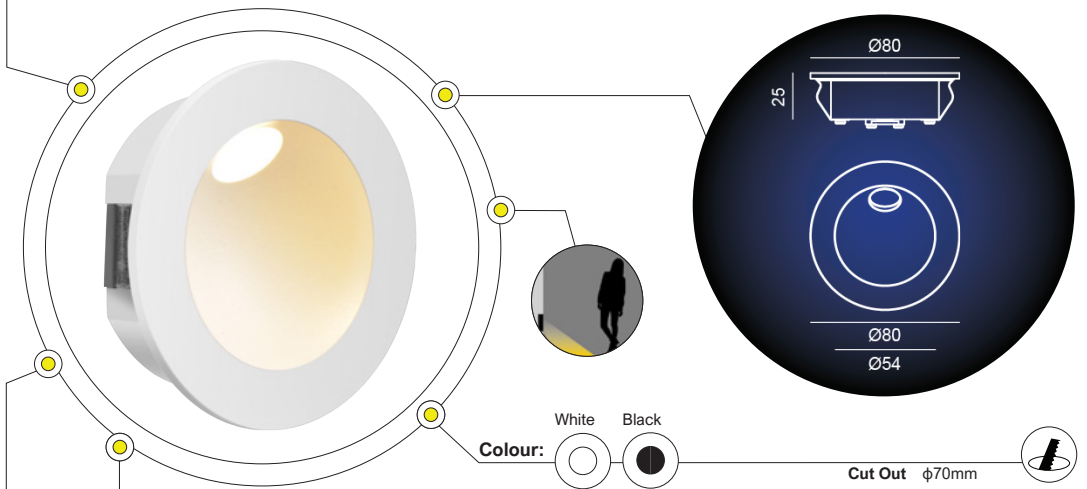

+ IP 54



LOA

5 YRS

ldt

PHYSICAL DATA

FEATURES

- Material: Aluminium
- The SNOW is a gorgeous miniature fixture and with its slim body, is ideal for installations in places where space is limited
- The SNOW creates a warm and comfortable ambience as the light comes out from within the deep shelter of the light
- Driver: On/Off

MOUNTING

Recessed

APPLICATION AREAS

Indoor, Commercial, Residential, Retail, Hospitality

TECHNICAL DATA

LF414817A

LAMP	LED
TOTAL POWER (W)	2.2W
SYSTEM OUTPUT (LM)	151LM
CCT (K)	3000K
CRI (Ra)	80
OPERATING VOLTAGE-VAC	100-240V
SOURCE POWER (W)	3.8W
SOURCE OUTPUT (LM)	170LM
FLICKER FACTOR	1935.48HZ / 6.15%
WEIGHT (KG)	0.2KG
DIMENSIONS	D:φ80 x W:25mm
CUT OUT	D:φ70mm

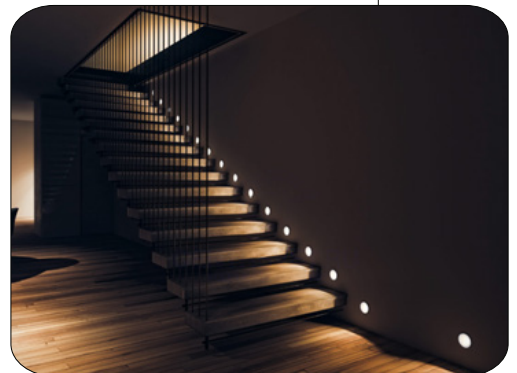

- CD / KLM
- C0 - C180
 - C90 - C270

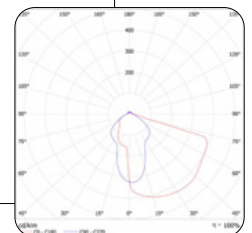

E&OE MAY OCCUR

TONE IN AISI316

FOOTLIGHTS

WALL - INDOOR FOOTLIGHTS - TONE IN

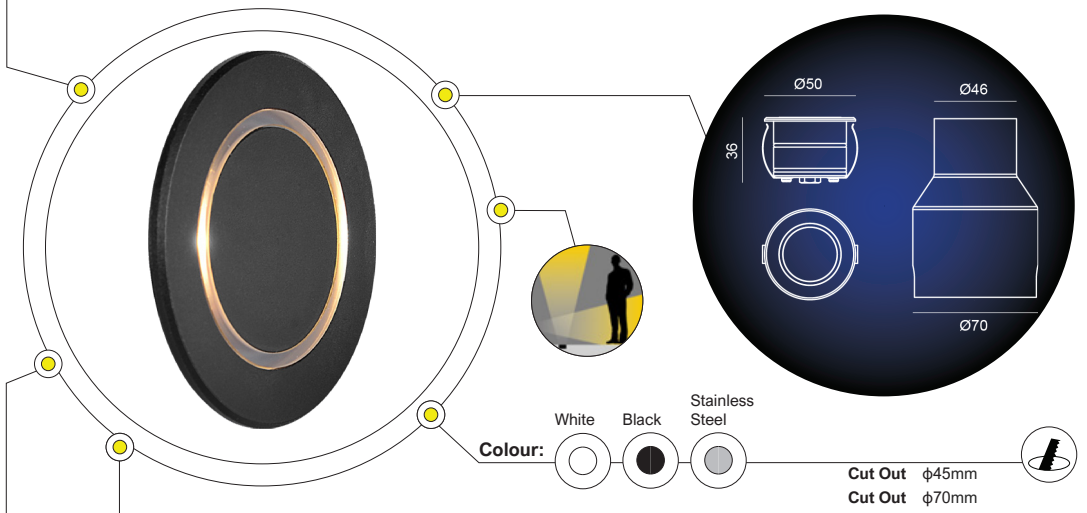

+ IP 65



LOA

5 YRS

ldt

PHYSICAL DATA

FEATURES

- Material : Aluminium
- The TONE IN is an excellent recessed guidance light in round-shaped frame
- It's unique and popular design of the inner ring creates soft and delicate lighting

available in stainless steel for selection

MOUNTING: Recessed, Wall and Floor

APPLICATION AREAS

Outdoor, Commercial, Residential, Retail, Hospitality

OPTIONS & ACCESSORIES

- The TONE IN AISI316 DC is a 24V 1.5W option

TECHNICAL DATA

LF413011A

LAMP	LED
TOTAL POWER (W)	2.1W
SYSTEM OUTPUT (LM)	15LM
CCT (K)	3000K
CRI (Ra)	80
OPERATING VOLTAGE-VAC	100-240V
SOURCE POWER (W)	4W
SOURCE OUTPUT (LM)	100LM
CURRENT (MA)	350MA
FLICKER FACTOR	1935.48HZ / 6.15%
WEIGHT (KG)	0.35KG
HOUSING DIMENSIONS	D:φ70 x H:46mm
DIMENSIONS	D:φ50 x H:36mm
CUT OUT	D:φ45mm / D:φ70mm

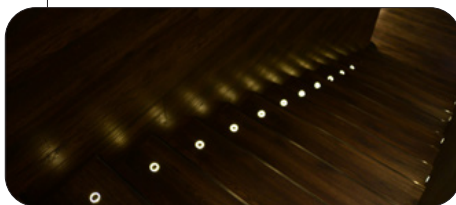
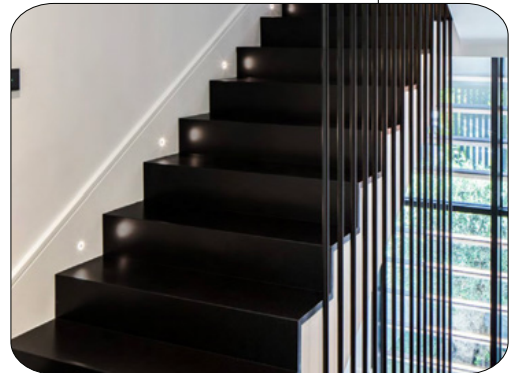

CD / KLM

● C0 - C180

● C90 - C270

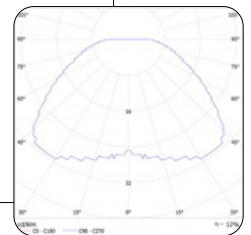

E&OE MAY OCCUR

> FLOOR

FLOOR LIGHTING



COLUMN F

FLOOR LAMPS

FLOOR – FLOOR LIGHTING – COLUMN F

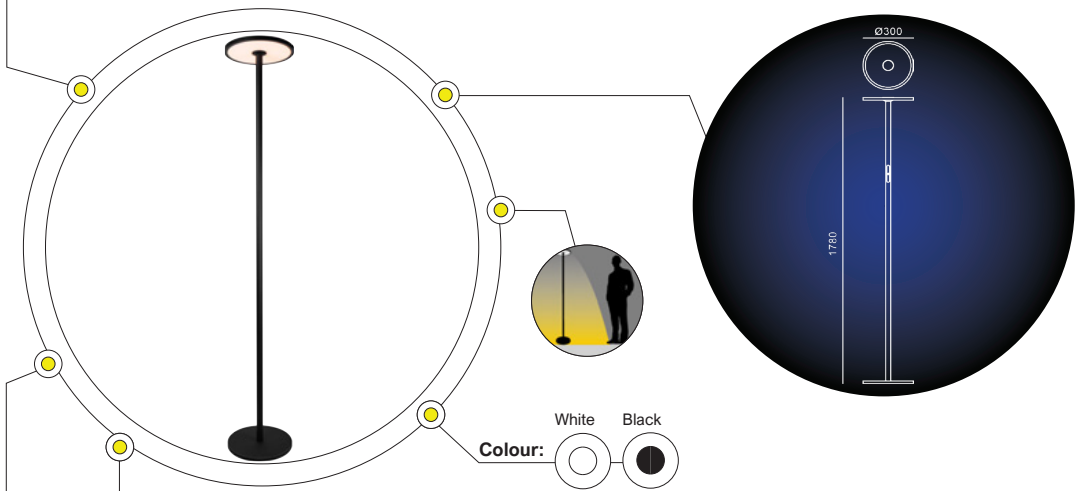

- + IP 20
-
- LOA**
- 3 YRS
- F

PHYSICAL DATA

FEATURES

- Material: Aluminium
- The COLUMN F has embodies classic design. It's ultra-slim pole with lighting disc that guarantees a powerful atmospheric lighting beam.
- Special magnetic mechanism allows the lighting disc to be turned so that light direction can be changed wither from the top or bottom
- Touch-Dim function included (sensor on pole of

luminaire)

OPTIONS & ACCESSORIES

- Table lamp available

MOUNTING: Surface (free-standing)

APPLICATION AREAS: Indoor, Commercial, Residential, Retail, Hospitality

TECHNICAL DATA

LF427414DT

LAMP	LED
TOTAL POWER (W)	26W
SYSTEM OUTPUT (LM)	1430LM
CCT (K)	3000K
CRI (Ra)	80
BEAM ANGLE	180°
OPERATING VOLTAGE-VAC	100-240V
SOURCE POWER (W)	28W
DIMMING RANGE	15-100%
DIMENSIONS	D:φ300 x H:1780mm

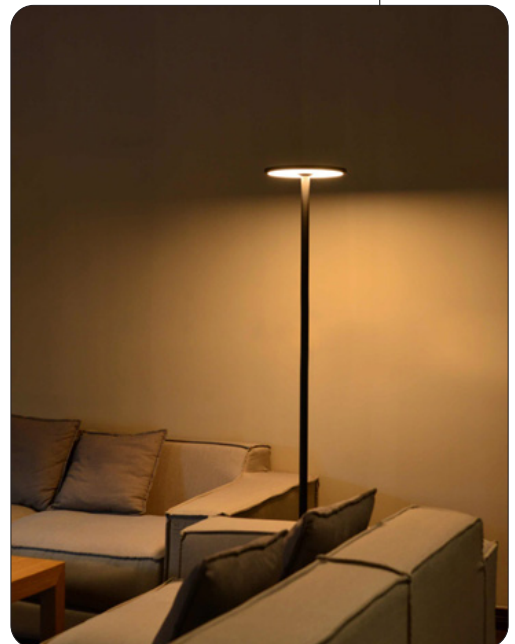

E&OE MAY OCCUR

FLASH M V RO SENSOR

FLOOR LAMPS

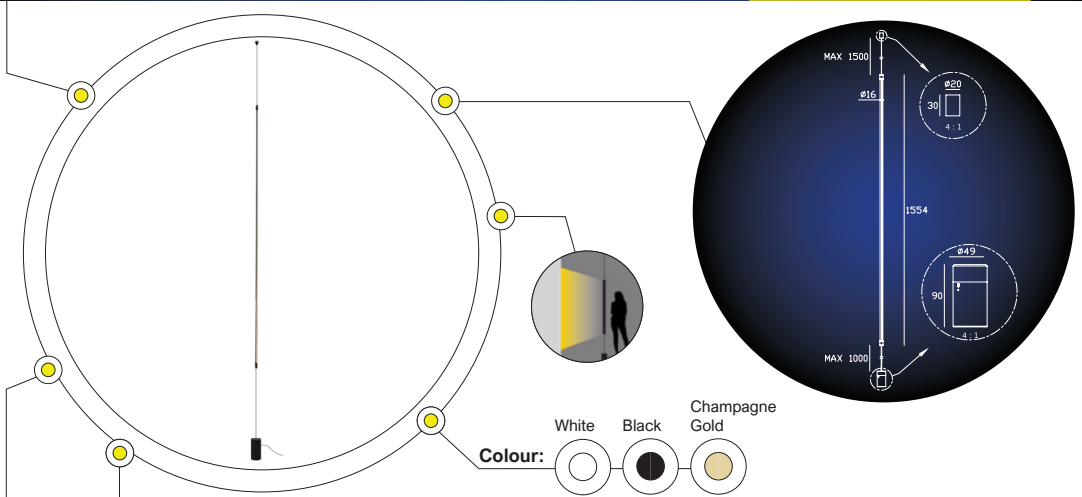

+ IP 20



LOA

3 YRS

ldt

PHYSICAL DATA

FEATURES

- Material : Aluminium
- The FLASH M V RO SENSOR is a sleek and sophisticated luminaire is a perfect example of artistic and creative vision. With it's versatile modern minimalism, it can serve as an accent light, ambient or task light
- Built-in infrared sensor, the FLASH M V RO SENSOR can be switched on/off and dimmed

OPTIONS & ACCESSORIES

- The FLASH M V RO with TRIAC Dim function is available

for selection

- The FLASH M P SQ is available as suspended horizontal pendant in two length options
- The FLASH CK is available for the Ultra Track System

MOUNTING

Surface

APPLICATION AREAS

Indoor, Commercial, Residential, Retail, Hospitality

TECHNICAL DATA

LF328619TD

LAMP	LED
TOTAL POWER (W)	30W
SYSTEM OUTPUT (LM)	1476LM
CCT (K)	3000K
CRI (Ra)	90
BEAM ANGLE	180°
OPERATING VOLTAGE-VAC	100-240V
SOURCE POWER (W)	33.8W
SOURCE OUTPUT (LM)	2890LM
FLICKER FACTOR	34.32HZ / 0.24%
ROD DIMENSIONS	D:φ16 x H:1554mm
SENSOR DIMENSIONS	D:φ49 x H:90mm
MOUNTING CUP	D:φ20 x H:30mm

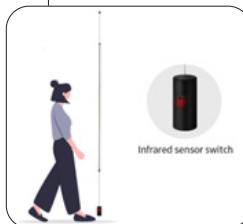
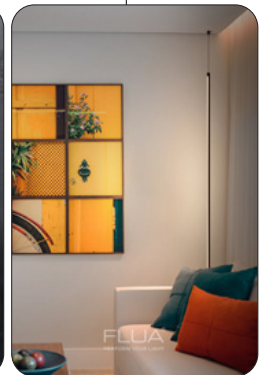

CD / KLM

● C0 - C180

● C90 - C270

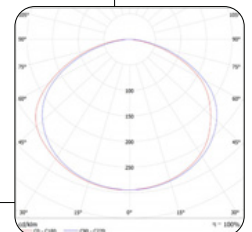

E&OE MAY OCCUR

HARI F

FLOOR LAMPS

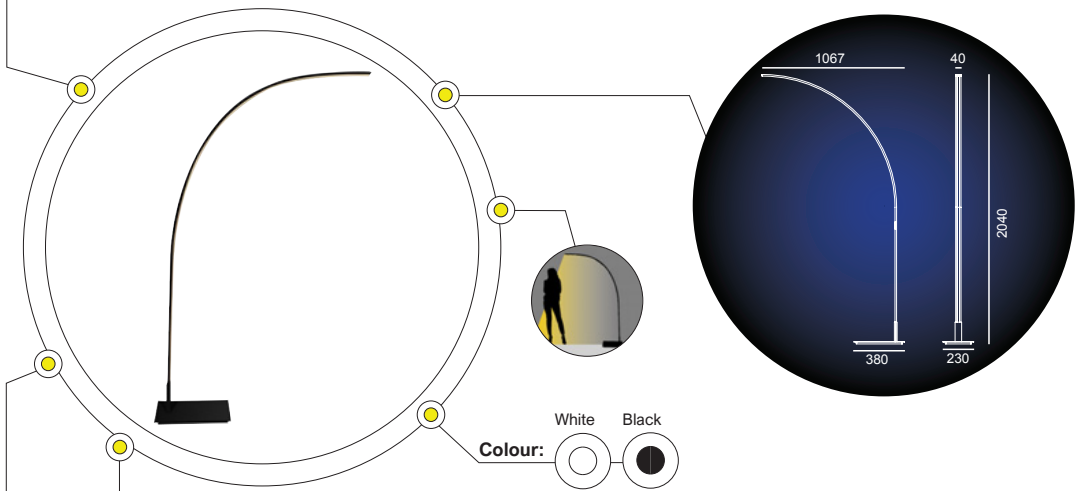

PHYSICAL DATA

FEATURES

- Material : Aluminium
- The HARI F is a sophisticated, award-winning floor lamp with a uniquely futuristic design
- The HARI F is a statement piece that will certainly elevate the design of the space it is in
- Convenient Touch-Dim function

MOUNTING

Surface (free-standing)

APPLICATION AREAS

Indoor, Commercial, Residential, Retail, Hospitality

+ IP 20



LOA

3 YRS

TECHNICAL DATA

LF432114TD

LAMP	LED
TOTAL POWER (W)	49.3W
SYSTEM OUTPUT (LM)	2107LM
CCT (K)	2700 - 5700K
CRI (Ra)	90
BEAM ANGLE	180°
OPERATING VOLTAGE-VAC	100-240V
SOURCE POWER (W)	15-100%
WEIGHT (KG)	17KG
BASE DIMENSIONS	L:230 x W:360mm
LUMINAIRE DIMENSIONS	H:2040 x W:40mm
LUMINAIRE SPAN	1067mm

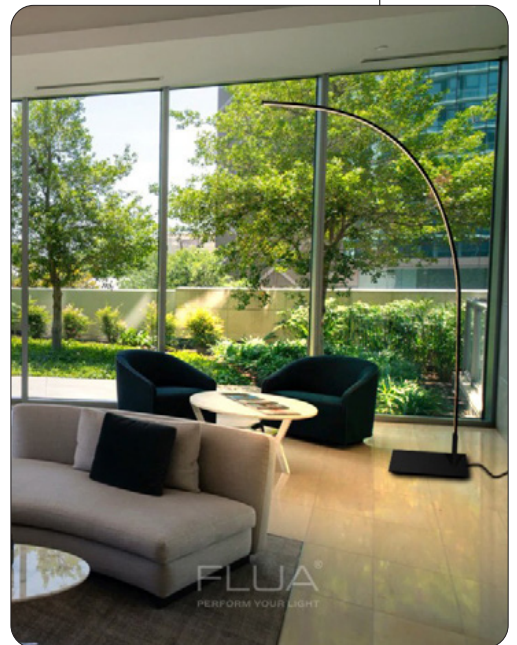
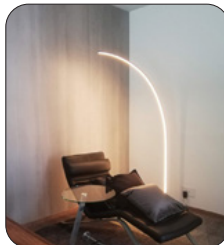

E&OE MAY OCCUR

SKIRT

FLOOR LAMPS

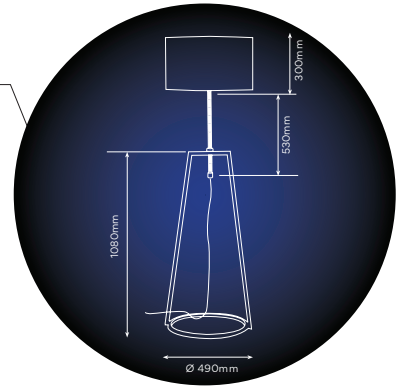
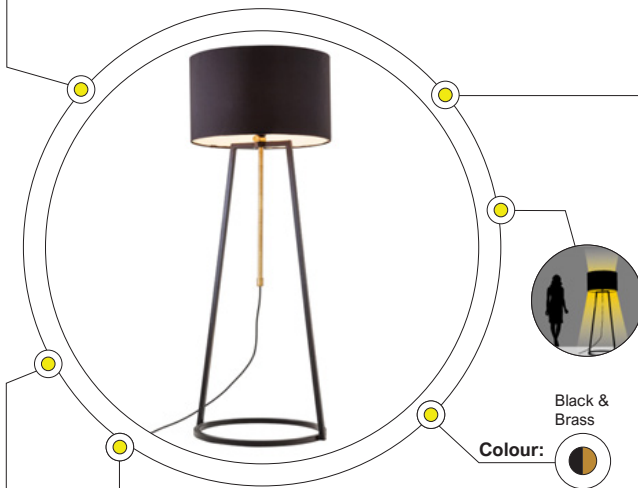

Black & Brass

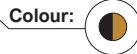

+ IP 20



✓ 1 YR

PHYSICAL DATA

FEATURES

- Material: Brass and steel
- Shade available in various colours for selection
- Excludes 1x E27 bulb

MOUNTING

Surface

APPLICATION AREAS

Indoor, Commercial, Residential, Retail, Hospitality

TECHNICAL DATA

LRD23GU1031

LAMP	E27
TOTAL POWER (W)	4W
OPERATING VOLTAGE-VAC	220-240V
CORD	L:2500mm
BASE DIMENSIONS	D:490 x H:1080mm
EXTENDED HEIGHT	H:530mm + 300mm(shade)

LAMP DATA

HX-LG125-4W

LAMP	LED
DIMMABLE	YES
BASE	E27
TOTAL POWER (W)	4W
TOTAL OUTPUT (LM)	350LM
CCT (K)	2200K
CRI (RA)	80
RATED LIFE (HRS)	15 000HRS
OPERATING VOLTAGE	220-240V
DIMENSIONS	D:18 x H:125mm



PLEASE NOTE

Lamp specifications and lamp warranties may differ

E&OE MAY OCCUR

➤ TABLE LIGHTING

COMMERCIAL & ARCHITECTURAL



COSMOS

TABLE LAMPS

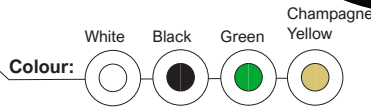
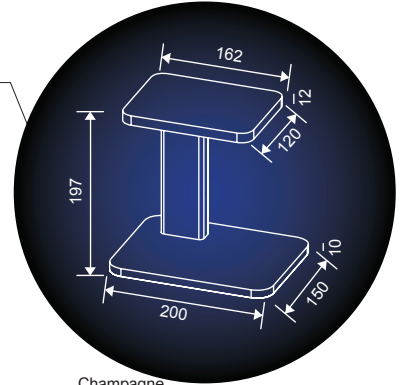
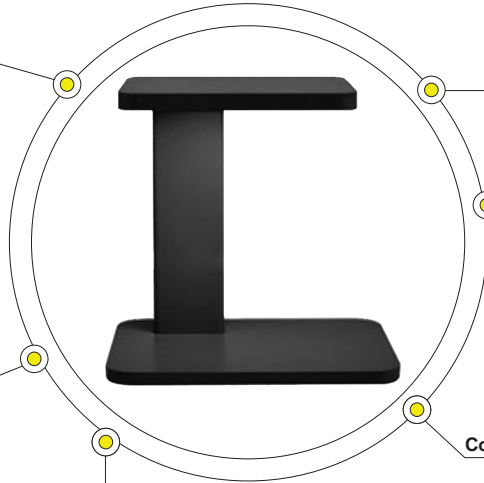

+ IP 20



LOA

3 YRS

PHYSICAL DATA

FEATURES

- Material : Aluminium
- The contemporary minimalist design of the COSMOS with its geometric form, bring interest to any space it illuminates
- The COSMOS is a great choice for auxiliary lighting
- Integrated USB charger port
- Touch Dimmable

MOUNTING

Surface

APPLICATION AREAS

Indoor, Commercial, Residential, Retail, Hospitality

TECHNICAL DATA

LF426514DT

LAMP	LED
TOTAL POWER (W)	7.6W
SYSTEM OUTPUT (LM)	411LM
CCT (K)	4000K
CRI (Ra)	90
OPERATING VOLTAGE-VAC	100-240V
SOURCE POWER (W)	8.6W
SOURCE OUTPUT (LM)	1308LM
WEIGHT (KG)	2.14KG
LIGHT DIMENSIONS	L:162 x H:12 x W:120mm
BASE DIMENSIONS	L:200 x H:10 x W:150mm
TOTAL HEIGHT	197mm

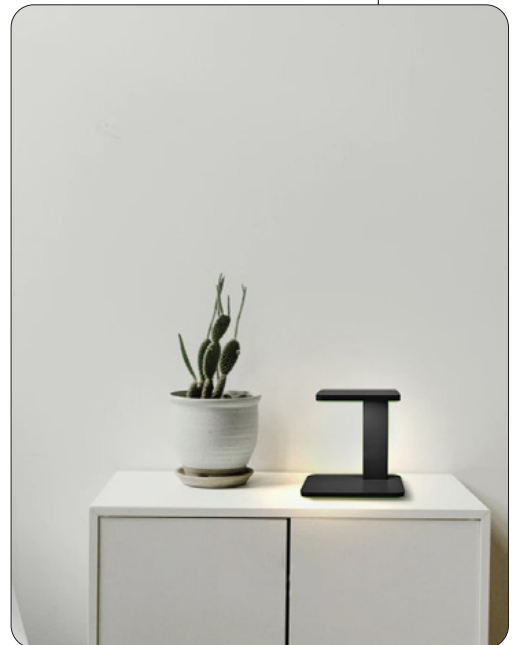

E&OE MAY OCCUR

FLOAT

TABLE LAMPS

FLOOR – TABLE LIGHTING – FLOAT

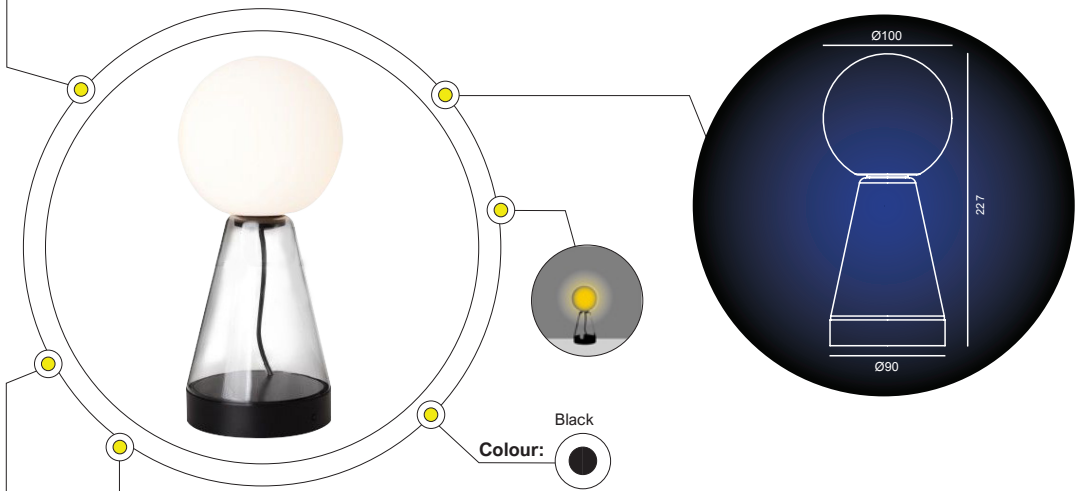

+ IP 65



LOA

3 YRS

PHYSICAL DATA

FEATURES

- Material: Glass and aluminium
- The FLOAT is a conical shaped table lamp that offers innovative design and multi -function, with it's wireless charging capability
- Built for the free souls, the FLOAT is suitable to both indoors and outdoors under its IP65 certification
- The sphere creates soft and comfortable lighting as it rests on the cone-shaped wireless charging pad

- The FLOAT is an ideal addition to any space
- Touch Dim function (touch-dim button on the base of the luminaire)

MOUNTING: Surface

APPLICATION AREAS

Indoor, Outdoor, Commercial, Residential, Retail, Hospitality

TECHNICAL DATA

LF438616TD

LAMP	LED
TOTAL POWER (W)	2.4W
SYSTEM OUTPUT (LM)	265LM
CCT (K)	3000K
CRI (Ra)	90
BEAM ANGLE	180°
OPERATING VOLTAGE-VAC	100-240V
SOURCE POWER (W)	3W
DIMMING RANGE	15 -100%
CURRENT (MA)	120MA
DIMENSIONS	D:φ100 x H:227mm



E&OE MAY OCCUR

GLASSY

TABLE LAMPS

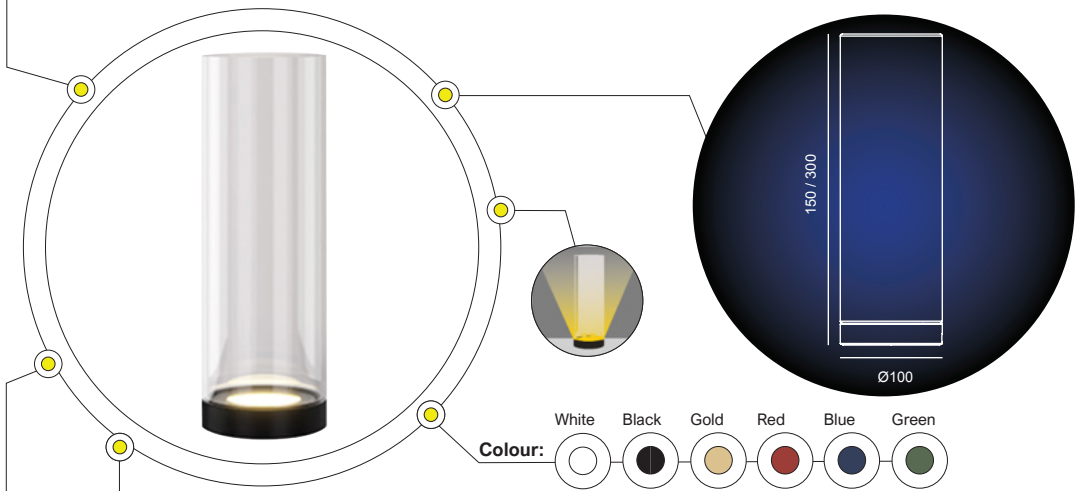

+ IP 20



LOA

5 YRS

PHYSICAL DATA

FEATURES

- Material : Aluminium with glass body
- The GLASSY offers a minimalist design aesthetic with the light source being at the base of this glass pillar
- Touch Dimmable
- Short-press for CCT adjustment
- Long-press for dimming
- Touch Dim function (touch-dim panel on the base of the luminaire)

FEATURES

- Length options: 150mm and 300mm for selection

MOUNTING

Surface

APPLICATION AREAS

Indoor, Commercial, Residential, Retail, Hospitality

TECHNICAL DATA

LF445619TD

LF444119TD

NAME	GLASSY S	GLASSY L
LAMP	LED	LED
TOTAL POWER (W)	2.5W	2.5W
SYSTEM OUTPUT (LM)	95LM	95LM
CCT (K)	6500K-4000K-2700K	6500K-4000K-2700K
CRI (Ra)	80	80
BEAM ANGLE	WIDE	WIDE
OPERATING VOLTAGE-VAC	5V DC	5V DC
SOURCE POWER (W)	4W	4W
SOURCE OUTPUT (LM)	320LM	320LM
CURRENT (MA)	150MA	150MA
DIMMING RANGE	5-100%	5-100%
DIMENSIONS	D:100 x H:150mm	D:100 x H:300mm



E&OE MAY OCCUR

SEPHORA V

TABLE LAMPS

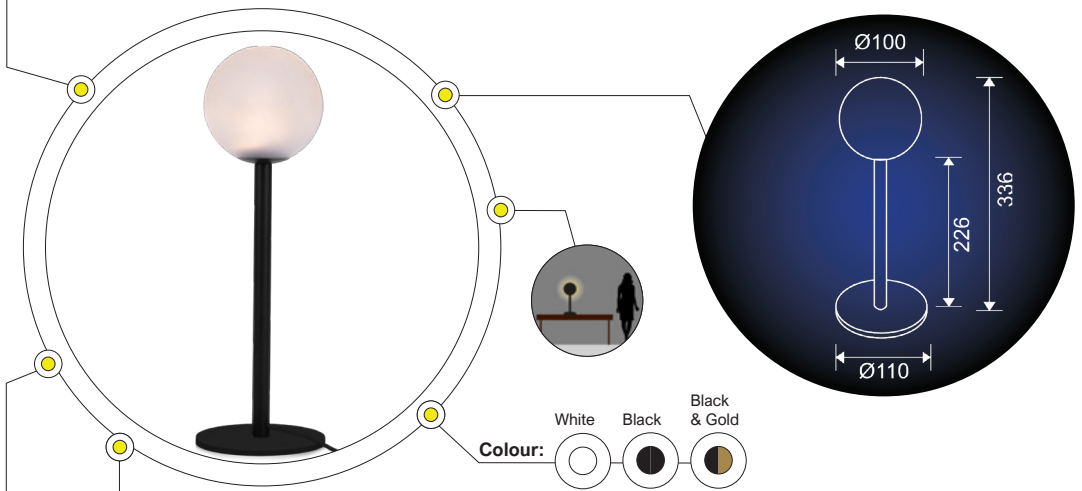

PHYSICAL DATA

+ IP 20



LOA

3 YRS

FEATURES

- Material: Aluminium and frosted glass globe
- The SEPHORA V is distinguished and sophisticated in its simplistic appearance where minimal design meets maximum functionality offer a soft and pleasant lighting experience for any room
- Touch Dim function

MOUNTING

Surface

APPLICATION AREAS

Indoor, Commercial, Residential, Retail, Hospitality

TECHNICAL DATA

LF430014

LAMP	LED
TOTAL POWER (W)	2.9W
SYSTEM OUTPUT (LM)	207LM
CCT (K)	3000K
CRI (Ra)	80
OPERATING VOLTAGE-VAC	100-240V
SOURCE POWER (W)	4W
DIMMING RANGE	15-100%
WEIGHT (KG)	1.4KG
DIMENSIONS	D:φ110 x H:336mm

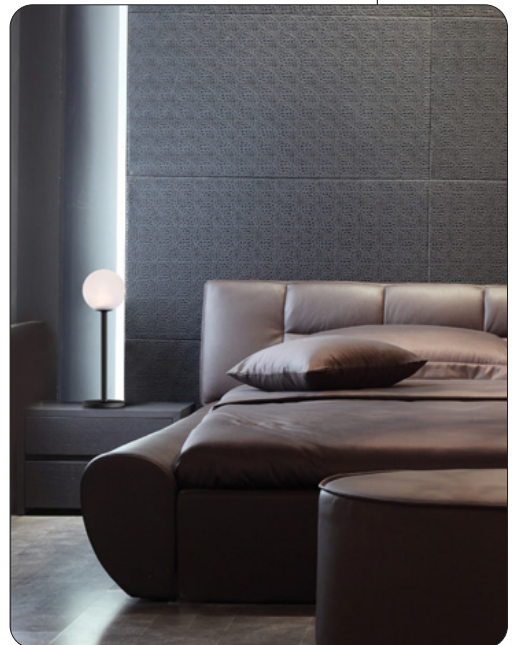
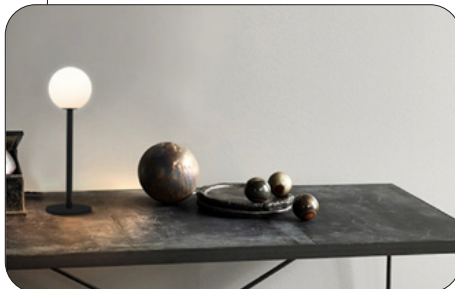

E&OE MAY OCCUR

LBLTL01GU10

TABLE LAMPS

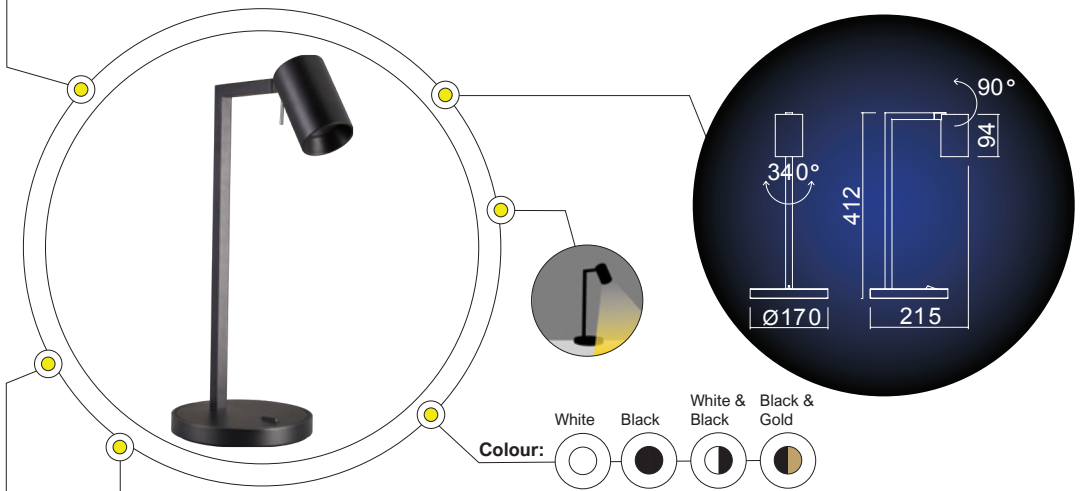

+ IP 65



LOA

3 YRS



PHYSICAL DATA

FEATURES

- Material: Aluminium and polycarbonate
- Adjustable with spot-head adjust of 90° tilt and 340° rotation

MOUNTING

Surface, Table

APPLICATION AREAS

Indoor, Commercial, Residential, Retail, Hospitality

TECHNICAL DATA

LBLTL01GU10

LAMP HOLDER	GU10
TOTAL POWER (W)	7.5W max
OPERATING VOLTAGE-VAC	220-240V
BASE DIMENSIONS	D:φ170mm
LAMP HEIGHT	H:94mm
DIMENSIONS	L:φ170 x W:215 x H:412mm

LAMP DATA

LPPAR165036

LAMP	LED
DIMMABLE	YES
BASE	GU10
TOTAL POWER (W)	5.5W
SYSTEM OUTPUT (LM)	380 / 400LM
CCT (K)	3000 / 4000 / 6500K
CRI (Ra)	90
BEAM ANGLE	36°
OPERATING VOLTAGE	220-240V
RATED LIFE (HRS)	25 000HRS
DIMENSIONS	D:φ51 x H:52mm



PLEASE NOTE

Lamp specifications and lamp warranties may differ

E&OE MAY OCCUR

> RECESSED UPLIGHTS

COMMERCIAL & ARCHITECTURAL

FLOOR - RECESSED UPLIGHTS



LGL01

RECESSED UPLIGHTS

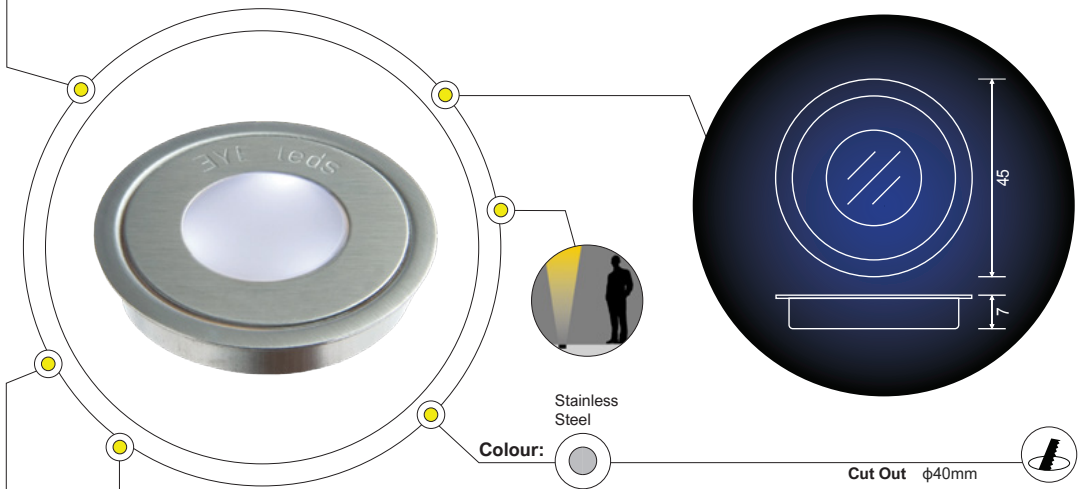

+ IP 67



3 YRS

PHYSICAL DATA

FEATURES

- Material: Marine grade stainless steel (304) in a brushed finish
- Remains cool to the touch
- Low profile installs flush
- Corrosion and UV resistant
- Engineered to withstand heavy use

OPTIONS & ACCESSORIES

- Available in cool white, warm white, blue and amber

MOUNTING

Recessed

APPLICATION AREAS

Outdoor, Indoor, Commercial, Residential, Retail, Hospitality

TECHNICAL DATA

LGL01

LAMP	LED
VOLTAGE	12V DC
POWER CONSUMPTION	0.3W / 25mA
SYSTEM OUTPUT (LM)	1.6 LM
CCT (K)	2700K - 5500K
RATED LIFE (HRS)	100 000 HRS
WALKOVER PRESSURE	max 285KG
SURFACE TEMPERATURE	34°C

NOTE: Driver supplied separately

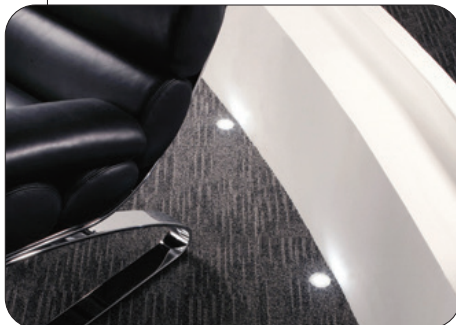

E&OE MAY OCCUR

LGL02

RECESSED UPLIGHTS

FLOOR - RECESSED UPLIGHTS - LGL02

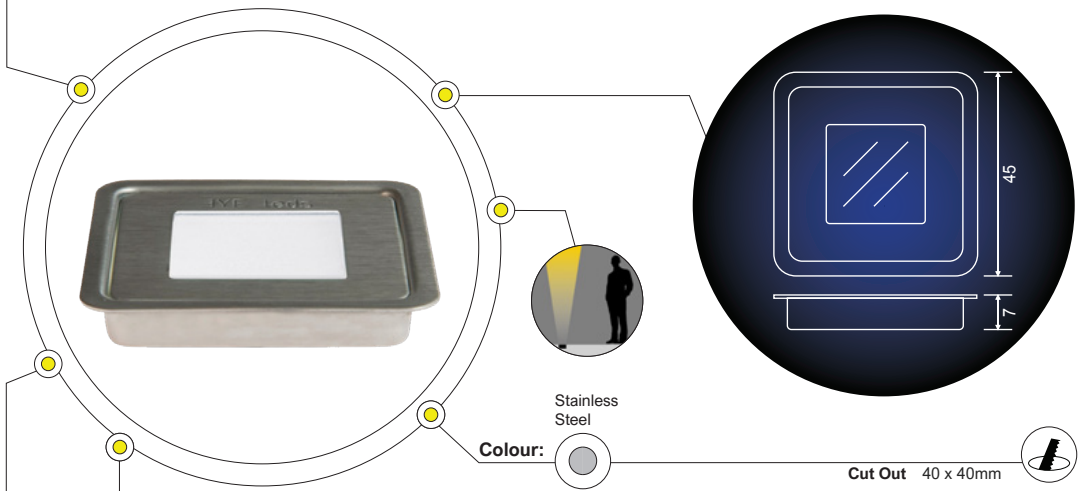

+ IP 67



3 YRS

PHYSICAL DATA

FEATURES

- Material: Marine grade stainless steel (304) in a brushed finish
- Remains cool to the touch
- Low profile installs flush
- Corrosion and UV resistant
- Engineered to withstand heavy use

OPTIONS & ACCESSORIES

- Available in cool white, warm white, blue and amber

MOUNTING

Recessed

APPLICATION AREAS

Outdoor, Indoor, Commercial, Residential, Retail, Hospitality

TECHNICAL DATA

LGL02

LAMP	LED
VOLTAGE	12V DC
POWER CONSUMPTION	0.6W
SYSTEM OUTPUT (LM)	2LM
CCT (K)	2700K - 5500K
RATED LIFE (HRS)	100 000 HRS
WALKOVER PRESSURE	max 285KG
SURFACE TEMPERATURE	34°C

NOTE: Driver supplied separately

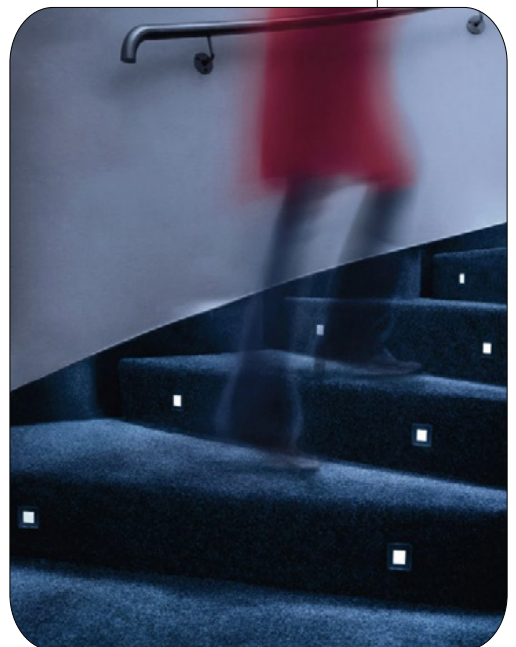

E&OE MAY OCCUR

MAX S

RECESSED UPLIGHTS



+ IP 67



LOA

3 YRS

ldt

PHYSICAL DATA

FEATURES

- Material: Stainless steel
- The Max is the best example of beauty and functionality and enhances the architectural character of any project
- Adjustable by adjusting the internal head

OPTIONS & ACCESSORIES

- The MAX S DC 24V option is available for selection

- Anti-glare cellular network available
- The MAX S, 7W Stainless steel lamp for 24V application with high temperature protection for harsh environments available

MOUNTING: In-Ground, Recessed

APPLICATION AREAS

Outdoor, Commercial, Residential, Retail, Hospitality

TECHNICAL DATA

LF656617

LAMP	LED
TOTAL POWER (W)	1.8W
SYSTEM OUTPUT (LM)	119LM
CCT (K)	2700 / 3000 / 4000K
CRI (Ra)	80
BEAM ANGLE	15° / 30°

OPERATING VOLTAGE-VAC	100-240V
SOURCE POWER (W)	2.6W
SOURCE OUTPUT (LM)	177LM
WEIGHT (KG)	0.43KG
LAMP DIMENSIONS	D:φ72 x H:78mm
HOUSING DIMENSIONS	D:φ63 x H:120mm
CUT OUT	D:φ58 / 64mm

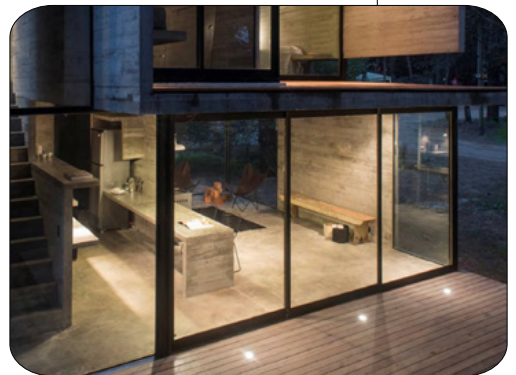

- CD / KLM
- C0 - C180
 - C90 - C270

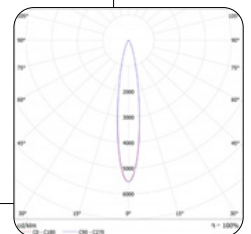

E&OE MAY OCCUR

> OUTDOOR

POST TOPS



LLEDPT01

POST TOPS

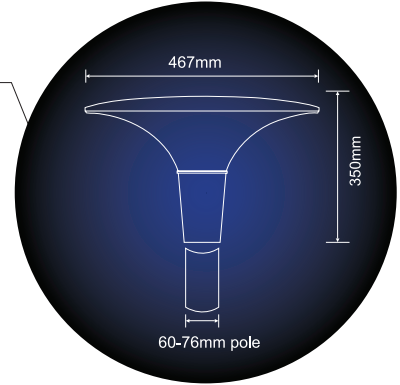
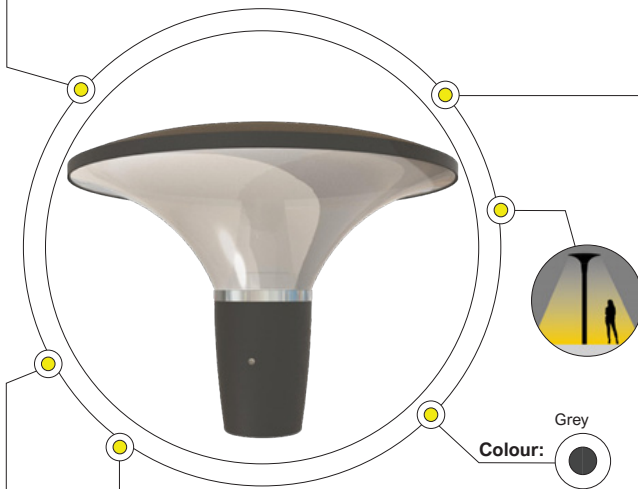

PHYSICAL DATA

FEATURES

- Lid is spun LM 6 aluminium – powder coated
- Base is glass filled nylon
- Lens is frosted opal acrylic
- Internally mounted Tridonic, Helvar or TCI control gear

MOUNTING

Outdoor, Post Top

APPLICATION AREAS

Outdoor, Commercial, Residential, Retail, Hospitality

OPTIONS & ACCESSORIES

- Dali, 1-10V, DMX, Triac dimmable with correct gear
- 76mm diameter pole available

TECHNICAL DATA

LLEDPT0130

LLEDPT0142

LAMP	LED	LED
TOTAL POWER (W)	30W	42W
SYSTEM OUTPUT (LM)	4200LM	5880LM
	20% loss through lens	20% loss through lens
EFFICACY (LM/W)	140	140
CCT (K)	3000K (factor extra 8% lumen loss)	3000K (factor extra 8% lumen loss)
	4000K / 5000K	4000K / 5000K
CRI (Ra)	>80	>80
BEAM ANGLE	SYMMETRICAL	SYMMETRICAL
OPERATING VOLTAGE-VAC	230V AC 50HZ	230V AC 50HZ
OPERATING TEMP °C	-20°C TO 40°C	-20°C TO 40°C
RATED LIFE (HRS)	50 000 HRS	50 000 HRS
POWER FACTOR	>0,95	>0,95
MAC ADAM STEP	3 SDCM	3 SDCM
DIMENSIONS	D:φ467 x H:350mm	D:φ467 x H:350mm
MOUNTING HEIGHT	3,5 TO 6M	3,5 TO 6M

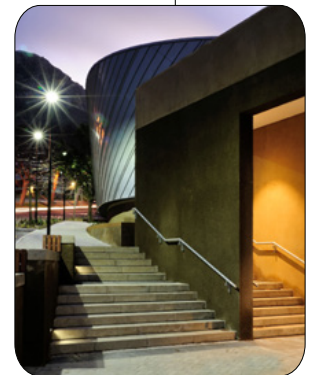

Project: Meici Clinic, Stellenbosch

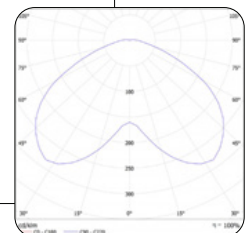

CD / KLM

● C0 - C180

● C90 - C270

E&OE MAY OCCUR

LLEDPT02

POST TOPS

OUTDOOR - POST TOPS - LLEDPT02

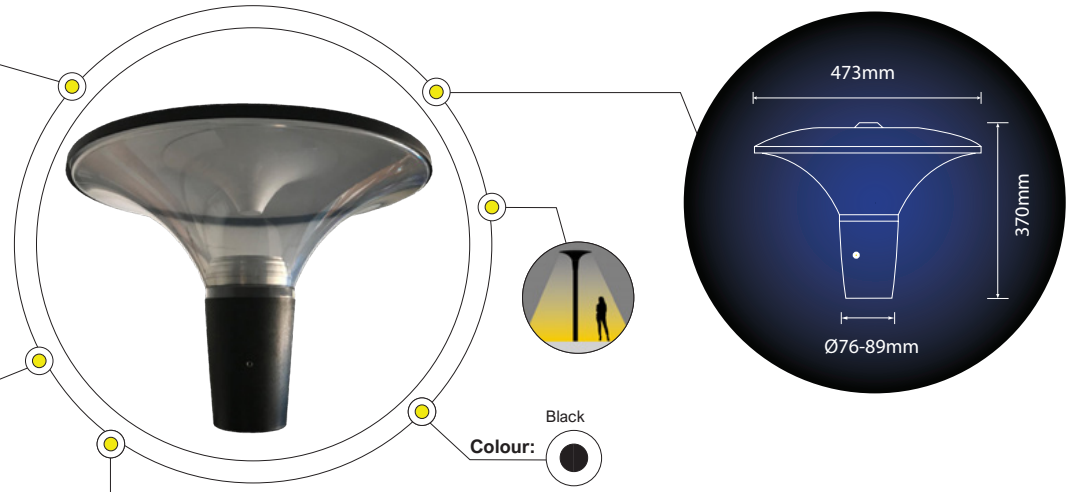

- + IP 66
-
- 5 YRS
-

PHYSICAL DATA

FEATURES

- Lid is spun LM 6 aluminium – powder coated
- Base is glass filled nylon
- Lens is Macralon - PC
- Internally mounted control gear - Tridonic, Helvar or TCI

MOUNTING

Outdoor, Post Top

APPLICATION AREAS

Outdoor, Commercial, Residential, Retail, Hospitality

OPTIONS & ACCESSORIES

- Dali, 1-10V, DMX, Triac dimmable with correct gear
- 76mm diameter pole available

TECHNICAL DATA

LLEDPT02

LAMP	LED
TOTAL POWER (W)	28W
SYSTEM OUTPUT (LM)	4088LM
	Factor for loss through lens
EFFICACY (LM/W)	140
CCT (K)	3000 / 4000 / 5000K
CRI (Ra)	>80
BEAM ANGLE	SYMMETRICAL
OPERATING VOLTAGE-VAC	230V AC 50HZ
OPERATING TEMP °C	-20°C TO 40°C
RATED LIFE (HRS)	50 000 HRS
POWER FACTOR	>0,95
MAC ADAM STEP	3 SDCM
DIMENSIONS	D:φ473 x H:370mm
MOUNTING HEIGHT	3,5 TO 6M

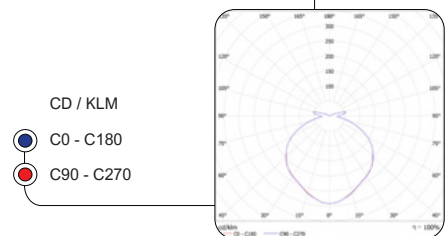

E&OE MAY OCCUR

> WALL - BULKHEADS

COMMERCIAL & ARCHITECTURAL



ORB

BULKHEAD

OUTDOOR - BULKHEADS - ORB

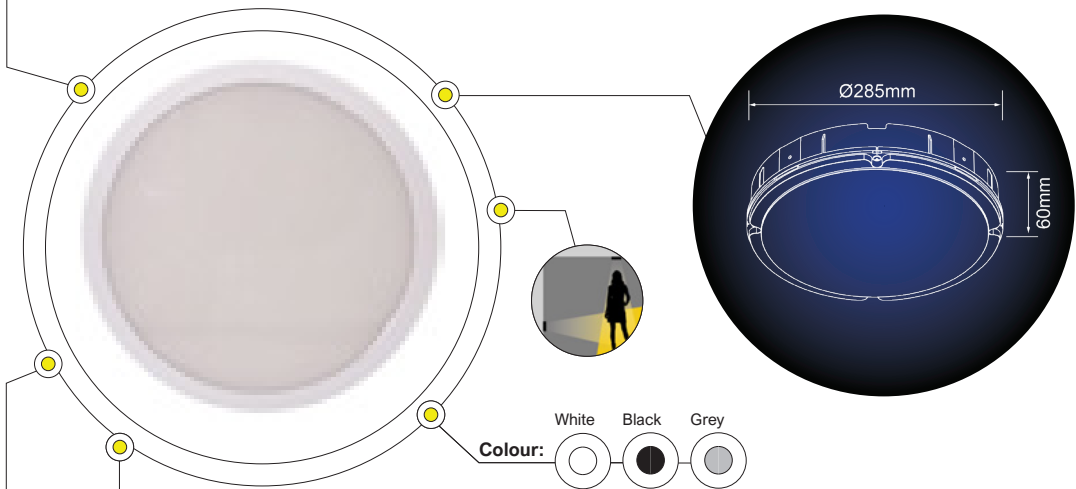

- + IP 65
- LOA
- 5 YRS
- ldt
- COLOUR SELECTABLE

PHYSICAL DATA

FEATURES

- Construction: Polycarbonate base, trim and diffuser, stainless steel screws
- Colour temperature CCT selectable between 3000K, 4000K and 6500K
- High-impact resistance body with IK10 rating
- Slim profile and high-efficiency

- Emergency, Microwave Sensor or Emergency & Microwave Sensor options available for selection
- Plain and Eyelid accessories available in white, black and grey
- Anti-tamper screws available for added security

OPTIONS & ACCESSORIES

- Suitable for switching by PIR, Microwave or Photocell

MOUNTING: Surface

APPLICATION AREAS

Outdoor, Commercial, Residential, Retail, Hospitality

TECHNICAL DATA

RRB14CCT3-01

LAMP	LED
TOTAL POWER (W)	7W
SYSTEM OUTPUT (LM)	819LM
CCT (K)	2700 / 3000 / 4000K
CRI (Ra)	90
BEAM ANGLE	55°

OPERATING VOLTAGE-VAC	100-240V
SOURCE POWER (W)	8.4W
CURRENT (mA)	200mA
LAMP DIMENSIONS	D:φ78 x H:105mm
HOUSING DIMENSIONS	D:φ70 x H:60mm
CUT OUT	D:φ72mm

RRBTRIMP - PLAIN & RRBTRIMEY - EYELID

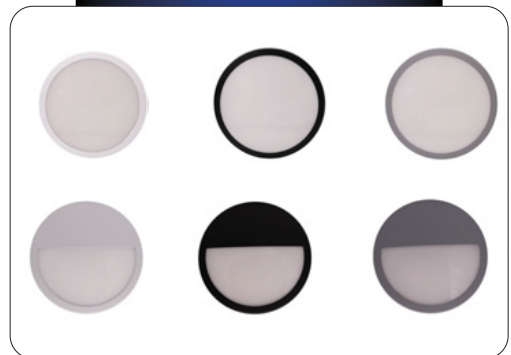

- CD / KLM
- C0 - C180
 - C90 - C270

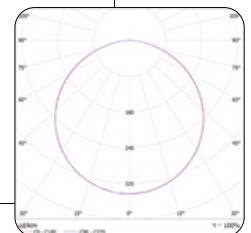

E&OE MAY OCCUR

LLEDBH01

BULKHEADS

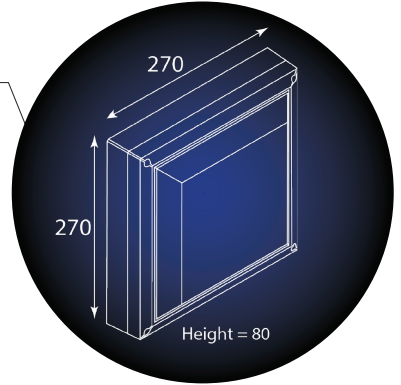
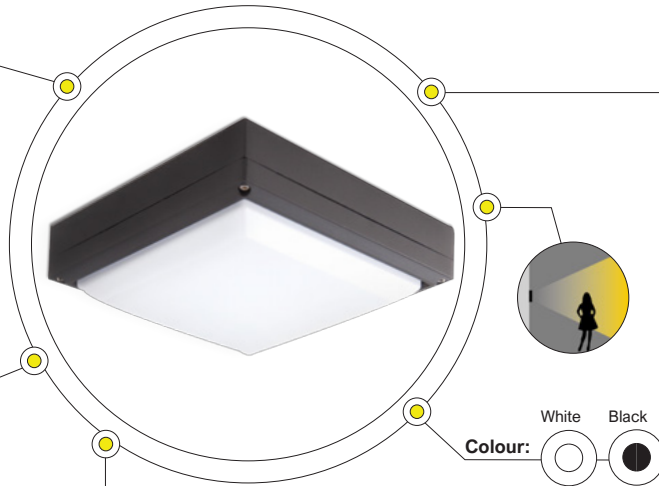

+ IP 65



3 YRS

ldt

PHYSICAL DATA

FEATURES

- Material: Die-cast aluminium (LM2) housing with stainless steel helicoils and a UV stable PMMA opal diffuser
- LED driver built in
- 1KV Surge Protection

- DALI, Occupancy Control, Daylight Harvesting, Time Switch Control and Bluetooth options available

MOUNTING

Surface

APPLICATION AREAS

Indoor, Outdoor, Commercial, Residential, Retail, Hospitality

OPTIONS & ACCESSORIES

- EMG 1hr or EMG 3hr available

TECHNICAL DATA

LLEDBH01153000

LLEDBH01154000

LAMP	LED	LED
TOTAL POWER (W)	12W	18W
SYSTEM OUTPUT (LM)	2016 / 2180LM	2775 / 3000LM
EFFICACY (LM/W)	163 / 177	152 / 165
CCT (K)	3000 / 4000K	3000 / 4000K
CRI (Ra)	>80	>80
BEAM ANGLE	120°	120°
OPERATING VOLTAGE-VAC	220-240V	220-240V
OPERATING TEMP °C	-20°C TO 45°C	-20°C TO 45°C
CURRENT (MA)	350MA	500MA
RATED LIFE (HRS)	50 000HRS	50 000HRS
POWER FACTOR	0.90	0.90
LUMEN MAINTENANCE	L70-B10	L70-B10
FLICKER FACTOR	<5%	<5%
MAC ADAM STEP	3 SDCM	3 SDCM
WEIGHT (KG)	2.25KG	2.25KG
DIMENSIONS	L:270 x W:270 x H:80mm	L:270 x W:270 x H:80mm

- CD / KLM
- C0 - C180
 - C90 - C270

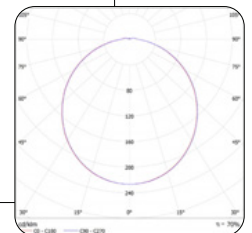

E&OE MAY OCCUR

LLEDBH02

BULKHEADS

OUTDOOR - BULKHEADS - LLEDBH02

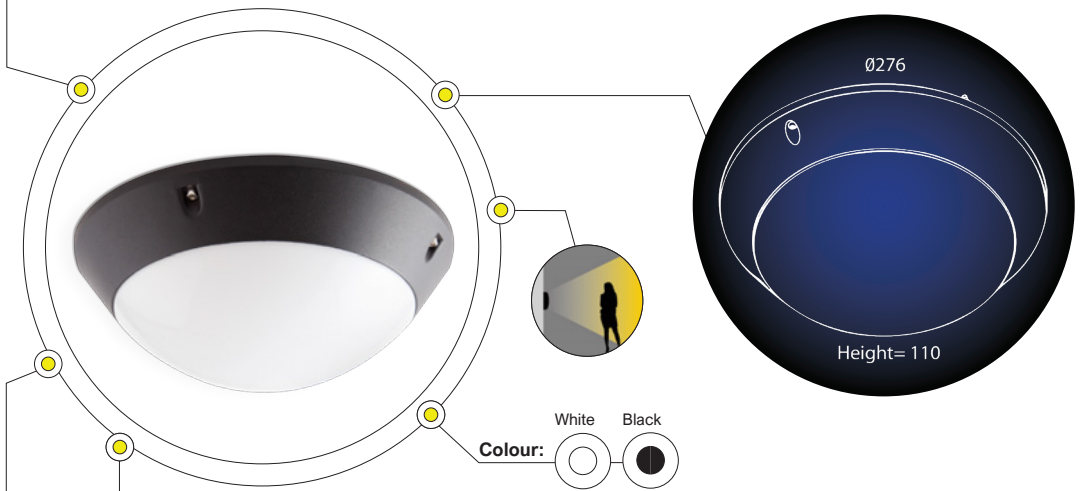

+ IP 65



3 YRS

ldt

PHYSICAL DATA

FEATURES

- Material: Die-cast aluminium (LM2) housing with stainless steel helicoils and a UV stable PMMA opal diffuser
- LED driver built in
- 1KV Surge Protection

- DALI, Occupancy Control, Daylight Harvesting, Time Switch Control and Bluetooth options available
- Side entry skirt available on request

MOUNTING: Surface

APPLICATION AREAS

Indoor, Outdoor, Commercial, Residential, Retail, Hospitality

OPTIONS & ACCESSORIES

- EMG 1hr or EMG 3hr available

TECHNICAL DATA

LLEDBH0215

LLEDBH0220

LAMP	LED	LED
TOTAL POWER (W)	11W	16W
SYSTEM OUTPUT (LM)	1585 / 1701LM	2162 / 2321LM
EFFICACY (LM/W)	148 / 159	137 / 147
CCT (K)	3000 / 4000K	3000 / 4000K
CRI (Ra)	>80	>80
BEAM ANGLE	120°	120°
OPERATING VOLTAGE-VAC	220-240V	220-240V
OPERATING TEMP °C	-20°C TO 45°C	-20°C TO 45°C
CURRENT (MA)	350MA	500MA
RATED LIFE (HRS)	50 000HRS	50 000HRS
POWER FACTOR	0.90	0.90
LUMEN MAINTENANCE	L70-B10	L70-B10
FLICKER FACTOR	<5%	<5%
MAC ADAM STEP	3 SDCM	3 SDCM
WEIGHT (KG)	1.35KG	1.35KG
DIMENSIONS	D:φ276 x H:110mm	D:φ276 x H:110mm

CD / KLM

● C0 - C180

● C90 - C270

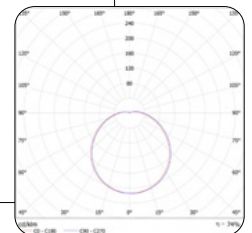

E&OE MAY OCCUR

LLEDBH06

BULKHEADS

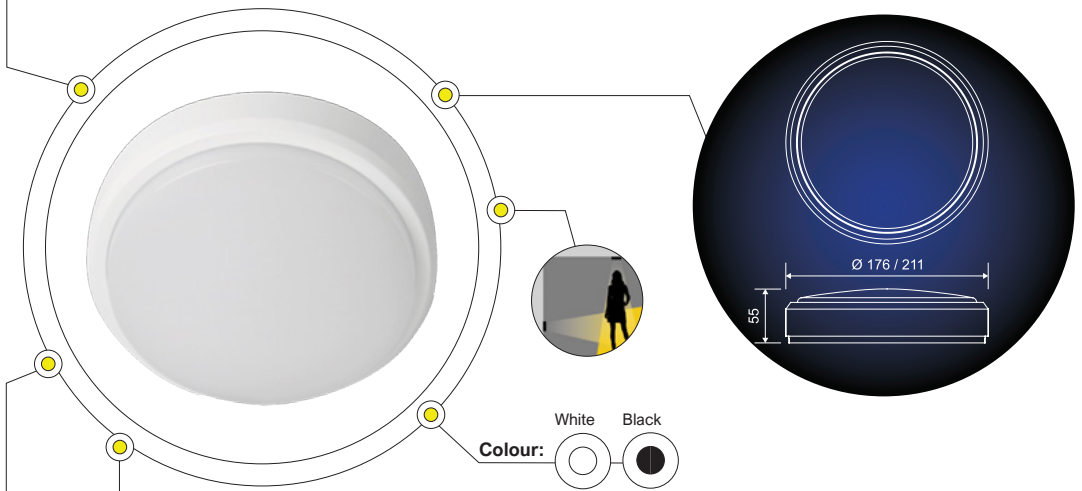

+ IP
54



LOA

3 YRS

ldt

PHYSICAL DATA

FEATURES

- Material: UV stabilized Polycarbonate housing and diffuser with aluminium LED tray and rubber-sealed cable entry
- No infra-red or ultra-violet in the light beam preventing fade and foliage damage
- Will not corrode and is durable with high impact rating
- Complete with white and black trims
- Non-dimmable
- Suitable for switching by PIR, Microwave or Photocell

OPTIONS & ACCESSORIES

- Round or Oval 8W, 12W and 18W options available for selection

MOUNTING

Surface

APPLICATION AREAS

Indoor, Outdoor, Commercial, Residential, Retail, Hospitality

TECHNICAL DATA

LLEDBH01153000

LLEDBH01154000

LAMP	LED	LED
TOTAL POWER (W)	8.8W	12W
SYSTEM OUTPUT (LM)	640LM	910 / 950LM
EFFICACY (LM/W)	73	78 / 79
CCT (K)	3000K	3000K / 4000K
CRI (Ra)	>80	>80
BEAM ANGLE	120°	120°
OPERATING VOLTAGE-VAC	220-240V	220-240V
OPERATING TEMP °C	-20°C TO 40°C	-20°C TO 40°C
RATED LIFE (HRS)	30 000HRS	30 000HRS
POWER FACTOR	0.5	0.5
LUMEN MAINTENANCE	L70B50	L70B50
ILLUM @ 1M (LUX)	180LX	250 / 280LX
IMPACT RATING (IK)	IK08	IK08
MAC ADAM STEP	<6 SDCM	<6 SDCM
WEIGHT (KG)	0.31KG	0.41KG
DIMENSIONS	D:φ176 x H:55mm	D:φ211 x H:55mm

CD / KLM

● C0 - C180

● C90 - C270

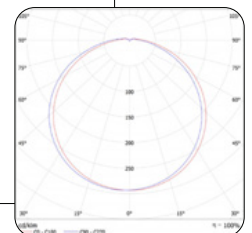

E&OE MAY OCCUR

> WALL LIGHTS

COMMERCIAL & ARCHITECTURAL

OUTDOOR - WALL LIGHTS



Project 169 on Main

APUS WR1

WALL LIGHTS

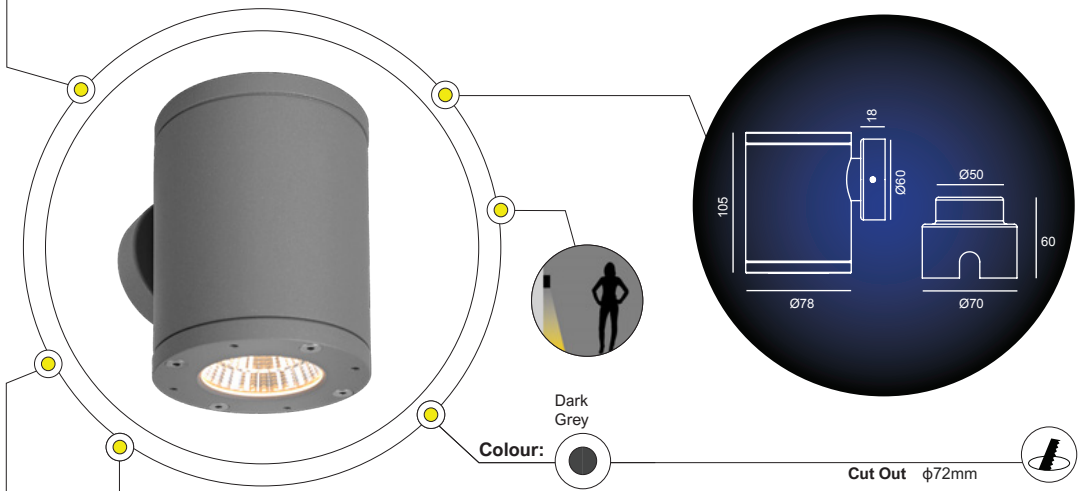

+ IP 65



LOA

3 YRS

ldt

PHYSICAL DATA

FEATURES

- Material: Aluminium
- The APUS has an elegant tubular design that will enhance your outdoor illumination beautifully
- Easy Installation, weatherproof finish
- On mounting: Mounting plate smaller than standard draw box

- The APUS is available in round, square with single or up/down (double lamp) as well as 24V DC options available for selection

MOUNTING

Recessed

APPLICATION AREAS

Outdoor, Commercial, Residential, Retail, Hospitality

OPTIONS & ACCESSORIES

TECHNICAL DATA

LF435315EA

LAMP	LED
TOTAL POWER (W)	7W
SYSTEM OUTPUT (LM)	819LM
CCT (K)	2700 / 3000 / 4000K
CRI (Ra)	90
BEAM ANGLE	55°

OPERATING VOLTAGE-VAC	100-240V
SOURCE POWER (W)	8.4W
CURRENT (MA)	200MA
LAMP DIMENSIONS	D:φ78 x H:105mm
HOUSING DIMENSIONS	D:φ70 x H:60mm
CUT OUT	D:φ72mm

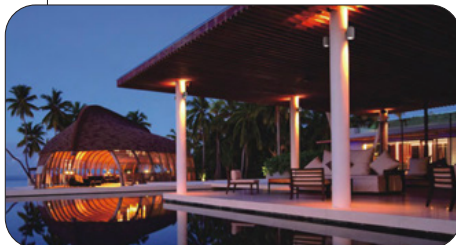
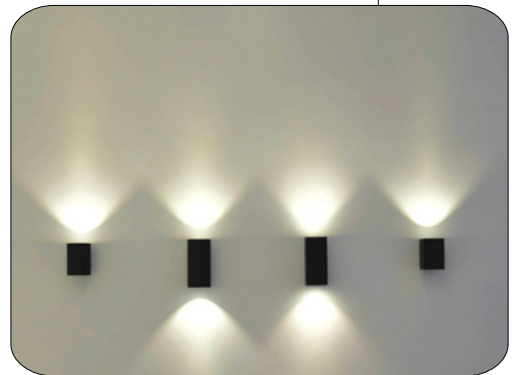

CD / KLM

● C0 - C180

● C90 - C270

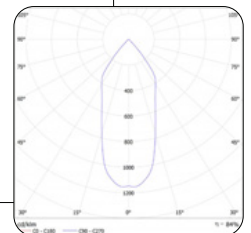

E&OE MAY OCCUR

APUS WR2

WALL LIGHTS

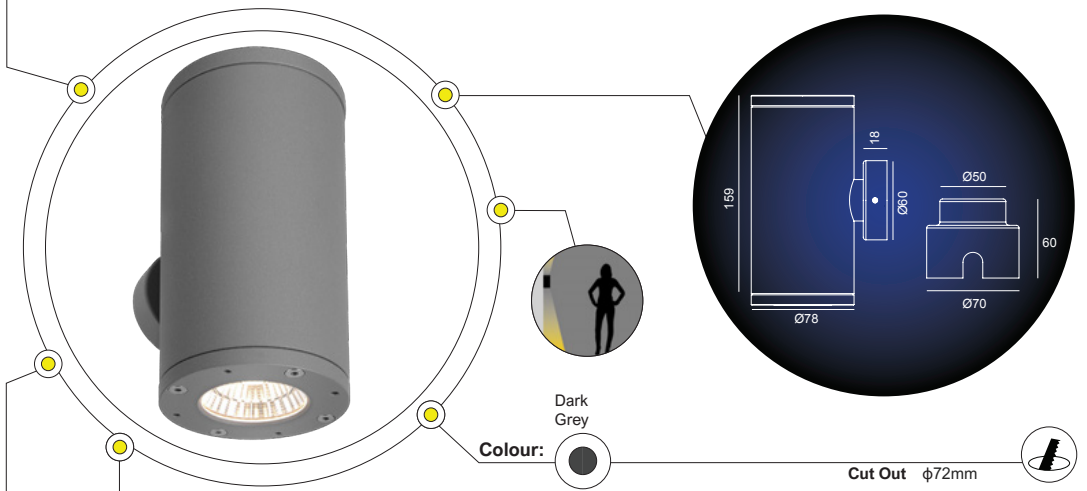

PHYSICAL DATA

FEATURES

- Material: Aluminium
- The APUS has an elegant tubular design that will enhance your outdoor illumination beautifully
- Easy Installation, weatherproof finish
- On mounting: Mounting plate smaller than standard draw box

OPTIONS & ACCESSORIES

- The APUS is available in round, square with single or up/down (double lamp) as well as 24V DC options available for selection

MOUNTING: Recessed

APPLICATION AREAS

Outdoor, Commercial, Residential, Retail, Hospitality

+ IP 65



LOA



TECHNICAL DATA

LF435515EA

LAMP	LED
TOTAL POWER (W)	2 x 7W
SYSTEM OUTPUT (LM)	1448LM
CCT (K)	2700 / 3000 / 4000K
CRI (RA)	90
BEAM ANGLE	55°

OPERATING VOLTAGE-VAC	100-240V
SOURCE POWER (W)	16.8W
CURRENT (MA)	350MA
FLICKER FACTOR	128.48HZ / 0.26%
WEIGHT (KG)	1.0KG
LAMP DIMENSIONS	D:φ78 x H:159mm
HOUSING DIMENSIONS	D:φ70 x H:60mm
CUT OUT	D:φ72mm

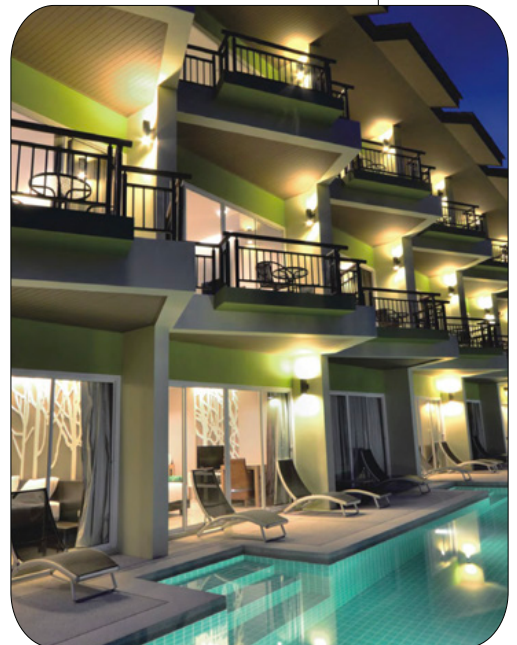
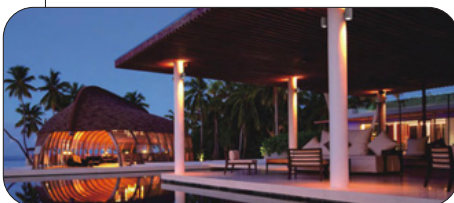

E&OE MAY OCCUR

APUS WS1

WALL LIGHTS

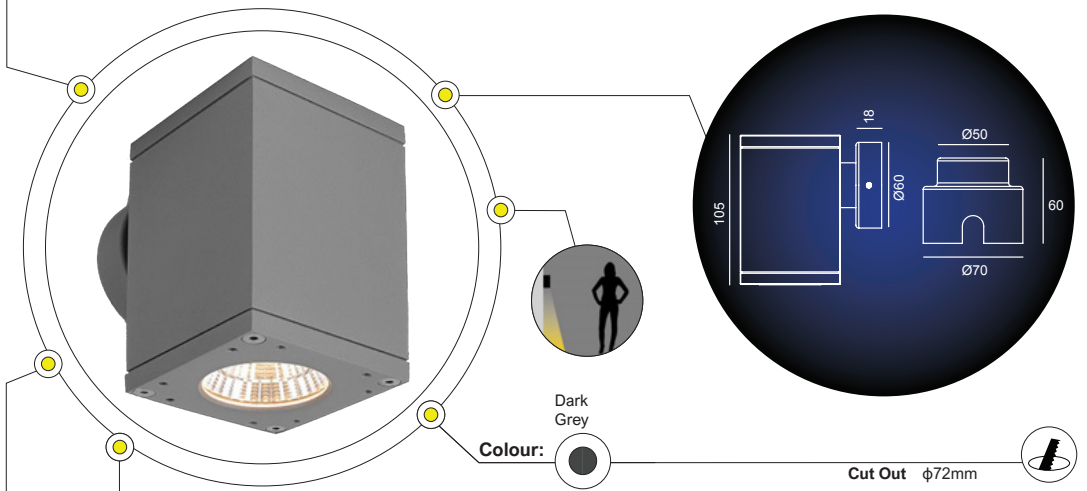

+ IP 65



LOA

3 YRS

ldt

PHYSICAL DATA

FEATURES

- Material: Aluminium
- The APUS has an elegant tubular design that will enhance your outdoor illumination beautifully
- Easy Installation, weatherproof finish
- On mounting: Mounting plate smaller than standard draw box

- The APUS is available in round, square with single or up/down (double lamp) as well as 24V DC options available for selection

MOUNTING

Recessed

APPLICATION AREAS

Outdoor, Commercial, Residential, Retail, Hospitality

OPTIONS & ACCESSORIES

TECHNICAL DATA

LF435715EA

LAMP	LED
TOTAL POWER (W)	7W
SYSTEM OUTPUT (LM)	865LM
CCT (K)	2700 / 3000 / 4000K
CRI (Ra)	90
BEAM ANGLE	55°
OPERATING VOLTAGE-VAC	100-240V
SOURCE POWER (W)	8.4W
CURRENT (MA)	200MA
LAMP DIMENSIONS	L:70 x W:70 x H:105mm
HOUSING DIMENSIONS	D:φ70 x H:60mm
CUT OUT	D:φ72mm

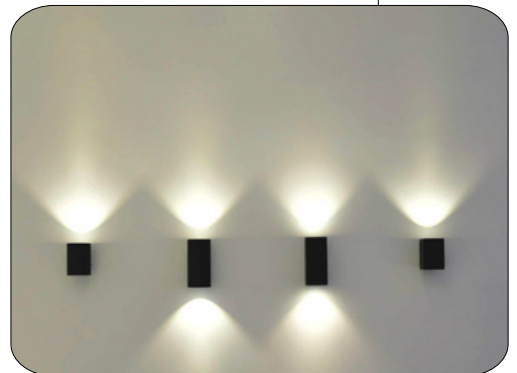

- CD / KLM
- C0 - C180
 - C90 - C270

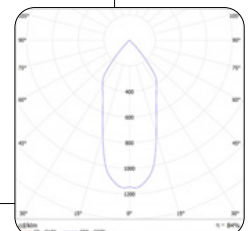

E&OE MAY OCCUR

APUS WS2

WALL LIGHTS

OUTDOOR - WALL LIGHTS - APUS WS2

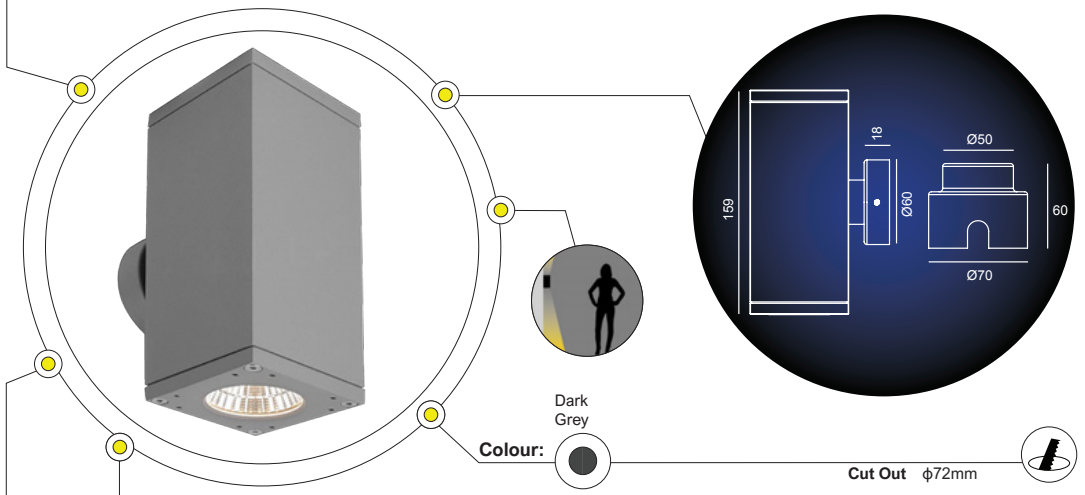

+ IP 65



LOA

3 YRS

PHYSICAL DATA

FEATURES

- Material: Aluminium
- The APUS has an elegant tubular design that will enhance your outdoor illumination beautifully
- Easy Installation, weatherproof finish
- On mounting: Mounting plate smaller than standard draw box

OPTIONS & ACCESSORIES

- The APUS is available in round, square with single or up/down (double lamp) as well as 24V DC options available for selection

MOUNTING: Recessed

APPLICATION AREAS

Outdoor, Commercial, Residential, Retail, Hospitality

TECHNICAL DATA

LF435915EA

LAMP	LED
TOTAL POWER (W)	2 x 7W
SYSTEM OUTPUT (LM)	1448LM
CCT (K)	2700 / 3000 / 4000K
CRI (RA)	90
BEAM ANGLE	55°
OPERATING VOLTAGE-VAC	100-240V
SOURCE POWER (W)	16.8W
CURRENT (MA)	350MA
FLICKER FACTOR	128.48HZ / 0.26%
LAMP DIMENSIONS	L:70 x W:70 x H:159mm
HOUSING DIMENSIONS	D:Ø70 x H:60mm
CUT OUT	D:Ø72mm

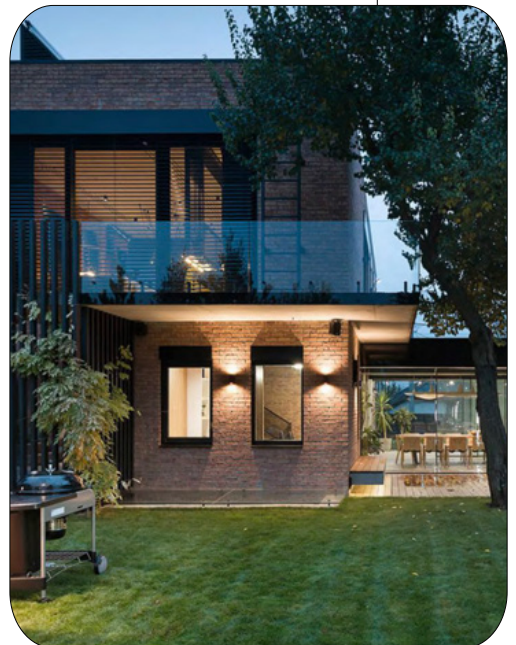

E&OE MAY OCCUR

CUBE SINGLE

WALL LIGHTS



Dark Grey

Colour:

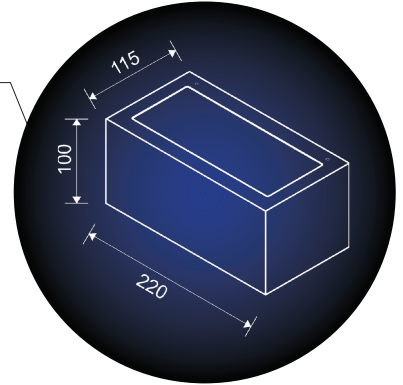

+ IP 65



LOA

3 YRS

ldt

PHYSICAL DATA

FEATURES

- Material: Aluminium
- The CUBE offers a classic design with a delineated shape that is ideal for outdoor use
- The CUBE DOUBLE offers up/down lighting

OPTIONS & ACCESSORIES

- The CUBE is available in 2 versions: single (light beam comes from one side) double up/down light beam

- The CUBE also offers 24V DC options for selection

MOUNTING

Surface

APPLICATION AREAS

Outdoor, Commercial, Residential, Retail, Hospitality

TECHNICAL DATA

LF422214

LAMP	LED
TOTAL POWER (W)	9W
SYSTEM OUTPUT (LM)	517LM
CCT (K)	2700 / 3000 / 4000K
CRI (Ra)	80
BEAM ANGLE	180°
OPERATING VOLTAGE-VAC	220-240V
SOURCE POWER (W)	12W
CURRENT (MA)	250MA
FLICKER FACTOR	99.83HZ / 1.63%
WEIGHT	1.68KG
LAMP DIMENSIONS	L220 x W:115 x H:100mm

CD / KLM

C0 - C180

C90 - C270

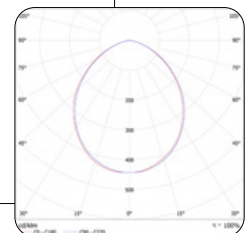

E&OE MAY OCCUR

CUBE DOUBLE

WALL LIGHTS

OUTDOOR - WALL LIGHTS - CUBE DOUBLE

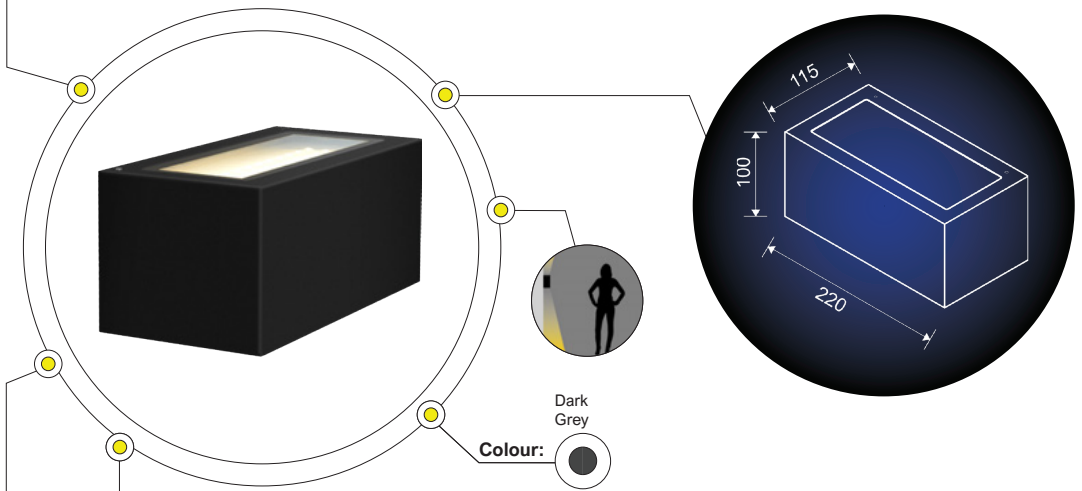

+ IP 65



LOA

3 YRS

PHYSICAL DATA

FEATURES

- Material: Aluminium
- The CUBE offers a classic design with a delineated shape that is ideal for outdoor use
- The CUBE DOUBLE offers up/down lighting

OPTIONS & ACCESSORIES

- The CUBE is available in 2 versions: single (light beam comes from one side) double up/down light beam

- The CUBE also offers 24V DC options for selection

MOUNTING

Surface

APPLICATION AREAS

Outdoor, Commercial, Residential, Retail, Hospitality

TECHNICAL DATA

LF422424

LAMP	LED
TOTAL POWER (W)	2 x 9W
SYSTEM OUTPUT (LM)	1034LM
CCT (K)	2700 / 3000 / 4000K
CRI (RA)	80
BEAM ANGLE	180°
OPERATING VOLTAGE-VAC	220-240V
SOURCE POWER (W)	15.6W
CURRENT (MA)	500MA
FLICKER FACTOR	100HZ / 1.63%
WEIGHT	1.65KG
LAMP DIMENSIONS	L220 x W:115 x H:100mm

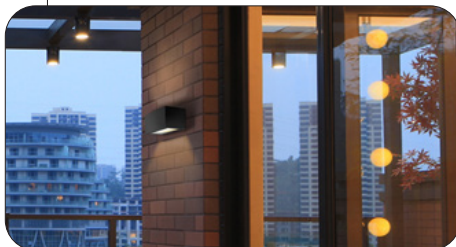

E&OE MAY OCCUR

> WALL LIGHTS

GU10



LWL15GU10

GU10 WALL LIGHT

OUTDOOR - WALL LIGHTS - GU10 - LWL15GU10

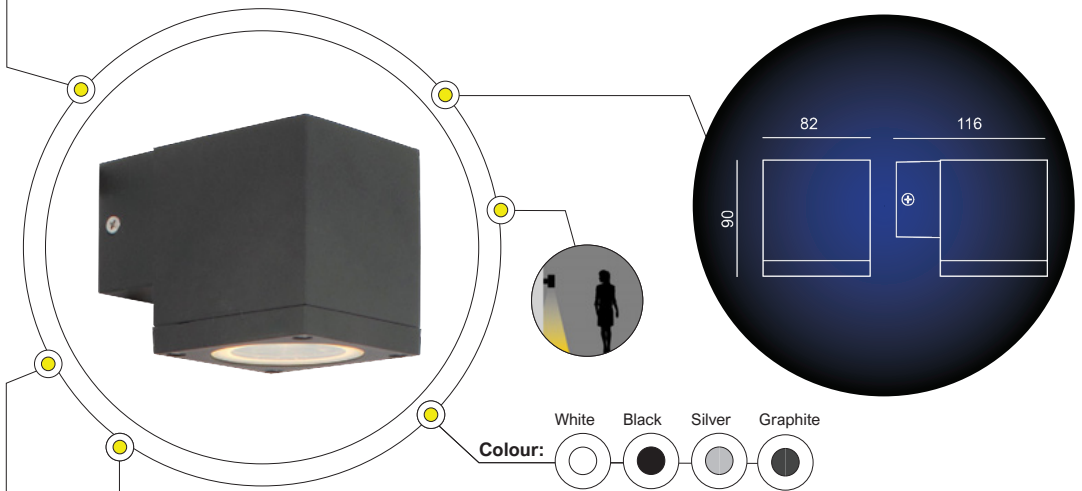

+ IP 65



5 YRS

PHYSICAL DATA

FEATURES

- Material: Die-cast aluminium with clear glass lens
- The LWL15GU10 can be positioned to be with either an upward or downward facing light beam

OPTIONS & ACCESSORIES

- The LWL152GU10, with Up/Down light beam, is available for selection

MOUNTING

Surface, Wall

APPLICATION AREAS

Outdoor, Commercial, Residential, Retail, Hospitality

TECHNICAL DATA

LWL15GU10

LAMP HOLDER	GU10 x 1
VOLTAGE	220-240V
DIMENSIONS	L:82 x W:116 x H:90mm

LAMP DATA

LPPAR165036

LAMP	LED
DIMMABLE	YES
BASE	GU10
TOTAL POWER (W)	5.5W
SYSTEM OUTPUT (LM)	380 / 400LM
CCT (K)	3000 / 4000 / 6500K
CRI (Ra)	90
BEAM ANGLE	36°
OPERATING VOLTAGE	220-240V
RATED LIFE (HRS)	25 000HRS
DIMENSIONS	D:φ51 x H:52mm



PLEASE NOTE

Lamp specifications and lamp warranties may differ

E&OE MAY OCCUR

LWL152GU10

GU10 WALL LIGHT

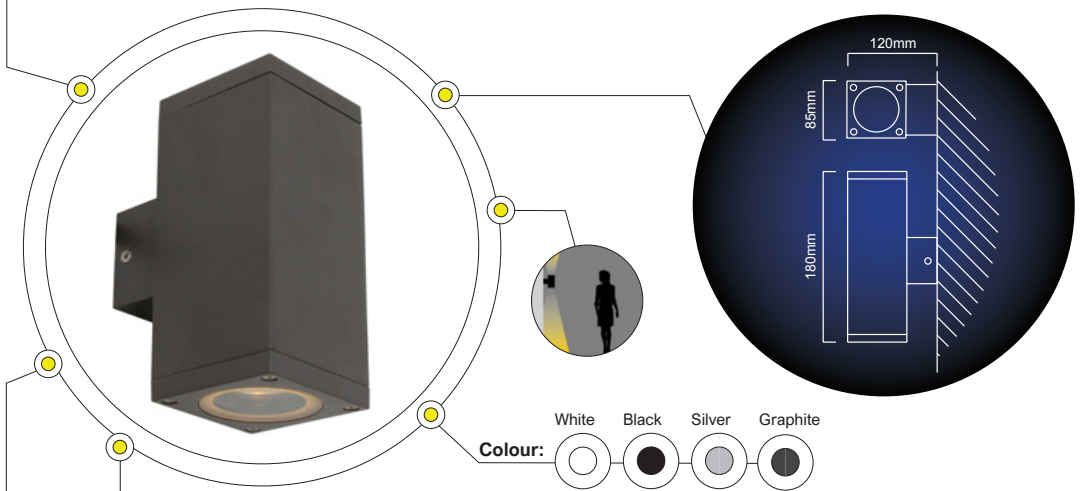

+ IP 65



5 YRS

PHYSICAL DATA

FEATURES

- Material: Die-cast aluminium with clear glass lens
- The LWL152GU10 has an Up/Down light beam

OPTIONS & ACCESSORIES

- The LWL15GU10 can be positioned to be with either an upward or downward facing light beams, is available for selection

MOUNTING

Surface, Wall

APPLICATION AREAS

Outdoor, Commercial, Residential, Retail, Hospitality

TECHNICAL DATA

LWL152GU10

LAMP HOLDER	GU10 x 2
VOLTAGE	220-240V
DIMENSIONS	L:85 x W:180 x H:120mm

LAMP DATA

LPPAR165036

LAMP	LED
DIMMABLE	YES
BASE	GU10
TOTAL POWER (W)	5.5W
SYSTEM OUTPUT (LM)	380 / 400LM
CCT (K)	3000 / 4000 / 6500K
CRI (Ra)	90
BEAM ANGLE	36°
OPERATING VOLTAGE	220-240V
RATED LIFE (HRS)	25 000HRS
DIMENSIONS	D:φ51 x H:52mm



PLEASE NOTE

Lamp specifications and lamp warranties may differ

LWL16GU10

GU10 WALL LIGHT

OUTDOOR - WALL LIGHTS - GU10 - LWL16GU10

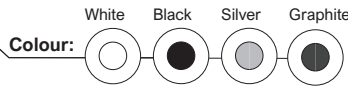
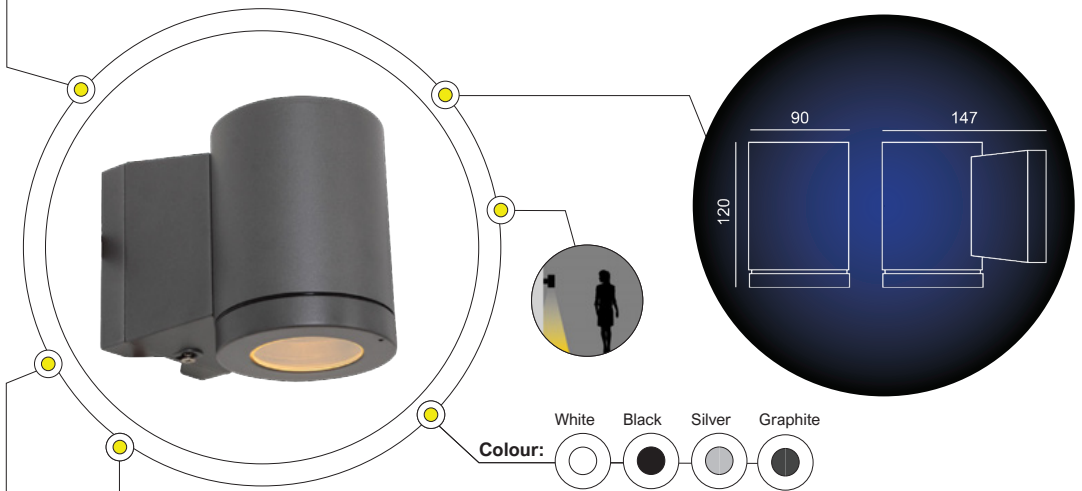

+ IP 65



5 YRS

PHYSICAL DATA

FEATURES

- Material: Die-cast aluminium with clear glass lens
- The LWL16GU10 can be positioned to be with either an upward or downward facing light beam

OPTIONS & ACCESSORIES

- The LWL162GU10, with Up/Down light beam, is available for selection

MOUNTING

Surface, Wall

APPLICATION AREAS

Outdoor, Commercial, Residential, Retail, Hospitality

TECHNICAL DATA

LWL16GU10

LAMP HOLDER	GU10 x 1
VOLTAGE	220-240V
DIMENSIONS	D:φ:90 x W:147 x H:120mm

LAMP DATA

LPPAR165036

LAMP	LED
DIMMABLE	YES
BASE	GU10
TOTAL POWER (W)	5.5W
SYSTEM OUTPUT (LM)	380 / 400LM
CCT (K)	3000 / 4000 / 6500K
CRI (Ra)	90
BEAM ANGLE	36°
OPERATING VOLTAGE	220-240V
RATED LIFE (HRS)	25 000HRS
DIMENSIONS	D:φ51 x H:52mm



PLEASE NOTE

Lamp specifications and lamp warranties may differ

E&OE MAY OCCUR

LWL162GU10

GU10 WALL LIGHT

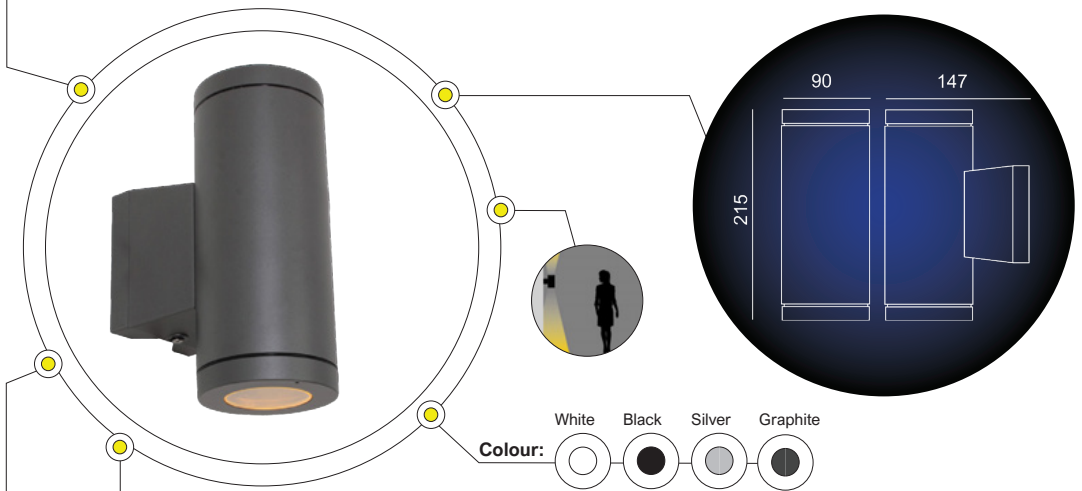

+ IP 65



5 YRS

PHYSICAL DATA

FEATURES

- Material: Die-cast aluminium with clear glass lens
- The LWL162GU10 has an Up/Down light beam

OPTIONS & ACCESSORIES

- The LWL16GU10 can be positioned to be with either an upward or downward facing light beams, is available for selection

MOUNTING

Surface, Wall

APPLICATION AREAS

Outdoor, Commercial, Residential, Retail, Hospitality

TECHNICAL DATA

LWL162GU10

LAMP HOLDER	GU10 x 2
VOLTAGE	220-240V
DIMENSIONS	D:φ:90 x W:147 x H:215mm

LAMP DATA

LPPAR165036

LAMP	LED
DIMMABLE	YES
BASE	GU10
TOTAL POWER (W)	5.5W
SYSTEM OUTPUT (LM)	380 / 400LM
CCT (K)	3000 / 4000 / 6500K
CRI (Ra)	90
BEAM ANGLE	36°
OPERATING VOLTAGE	220-240V
RATED LIFE (HRS)	25 000HRS
DIMENSIONS	D:φ51 x H:52mm



PLEASE NOTE

Lamp specifications and lamp warranties may differ

> LANTERNS



LBILLANT01

LANTERNS

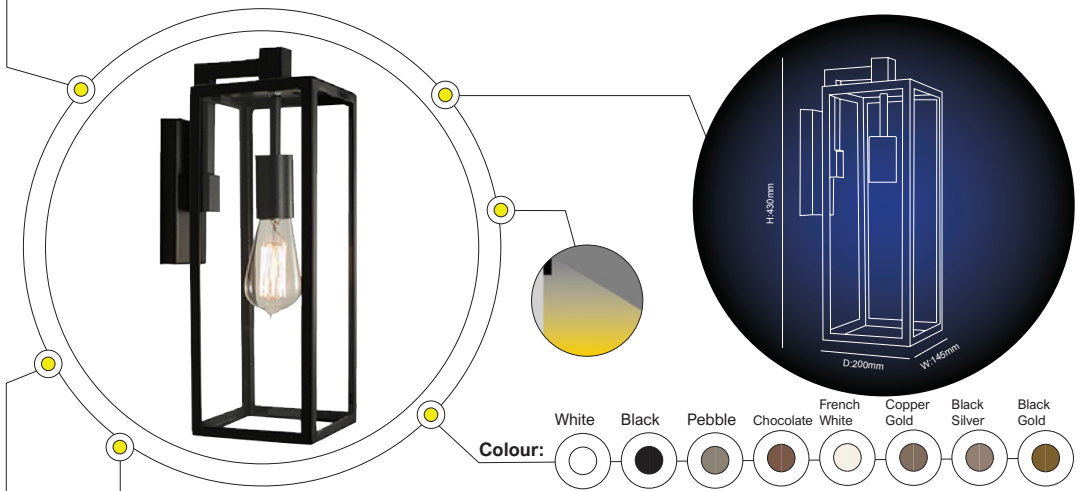

+ IP 65



5 YRS

PHYSICAL DATA

FEATURES

- Material: Aluminium
- The LBILLANT01 is a rectangular, wall-suspended outdoor lantern
- Clear-glass rectangular lantern ideal for coastal regions

OPTIONS & ACCESSORIES

- Eight colour finishes to choose from

MOUNTING

Surface

APPLICATION AREAS

Indoor, Outdoor, Commercial, Residential, Retail, Hospitality

TECHNICAL DATA

LBILLANT01

LAMP HOLDER	E27
VOLTAGE	220-240V
DIMENSIONS	W:145 x D:200 x H:430mm

LAMP DATA

G785

LAMP	CARBON FILAMENT
SHAPE	PEAR WITH NIPPLE
BASE	E27
TOTAL POWER (W)	60W
TOTAL OUTPUT (LM)	280LM
CCT (K)	2700K
CRI (RA)	80
RATED LIFE (HRS)	3000HRS
OPERATING VOLTAGE	230V
DIMENSIONS	D:φ63 x L:142mm



PLEASE NOTE

Lamp specifications and lamp warranties may differ

E&OE MAY OCCUR

LBILLANT02

LANTERNS

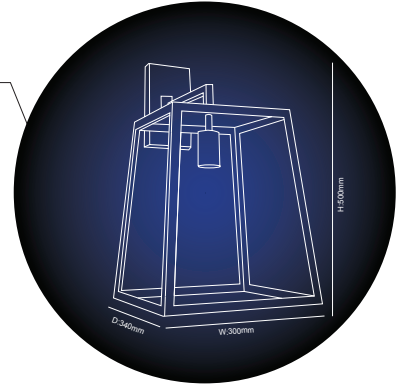

Colour:



PHYSICAL DATA

FEATURES

- Material: Anodized Aluminium
- LBILLANT02 outdoor wall lantern is a high quality indoor and outdoor contemporary wall suspended lantern
- Ideal for outdoor coastal areas
- Tapered square design and 4 clear glass panels

- Eight colour finishes to choose from

MOUNTING

Surface

APPLICATION AREAS

Indoor, Outdoor, Commercial, Residential, Retail, Hospitality

OPTIONS & ACCESSORIES

+ IP 65



5 YRS

TECHNICAL DATA

LBILLANT02

LAMP HOLDER	E27
VOLTAGE	220-240V
DIMENSIONS	W:300 x D:340 x H:500mm

LAMP DATA

G785

LAMP	CARBON FILAMENT
SHAPE	PEAR WITH NIPPLE
BASE	E27
TOTAL POWER (W)	60W
TOTAL OUTPUT (LM)	280LM
CCT (K)	2700K
CRI (RA)	80
RATED LIFE (HRS)	3000HRS
OPERATING VOLTAGE	230V
DIMENSIONS	D:φ63 x L:142mm



PLEASE NOTE

Lamp specifications and lamp warranties may differ

E&OE MAY OCCUR

LBILLANT03

LANTERNS

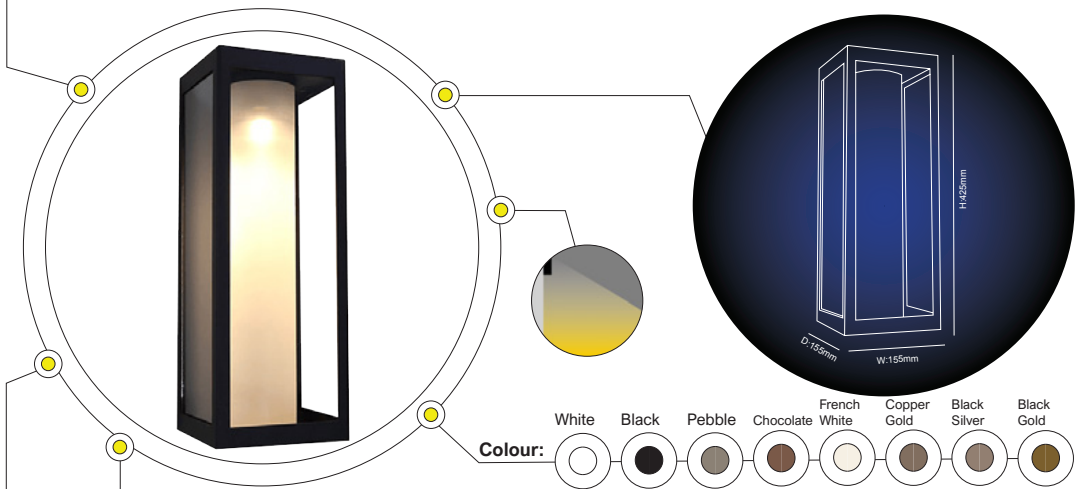

+ IP 65



5 YRS

PHYSICAL DATA

FEATURES

- Material: Powder-coated aluminium frame
- The LBILLANT03 is a contemporary indoor/outdoor rectangular wall lantern with inner frosted diffuser and 3 clear glass panels
- Ideal for outdoor coastal areas

MOUNTING

Surface

APPLICATION AREAS

Indoor, Outdoor, Commercial, Residential, Retail, Hospitality

OPTIONS & ACCESSORIES

- Eight colour finishes to choose from

TECHNICAL DATA

LBILLANT03

LAMP HOLDER	GU10 50W
VOLTAGE	220-240V
DIMENSIONS	W:155 x D:155 x H:425mm

LAMP DATA

LPPAR165036

LAMP	LED
DIMMABLE	YES
BASE	GU10
TOTAL POWER (W)	5.5W
SYSTEM OUTPUT (LM)	380 / 400LM
CCT (K)	3000 / 4000 / 6500K
CRI (Ra)	90
BEAM ANGLE	36°
OPERATING VOLTAGE	220-240V
RATED LIFE (HRS)	25 000HRS
DIMENSIONS	D:φ51 x H:52mm



PLEASE NOTE

Lamp specifications and lamp warranties may differ

E&OE MAY OCCUR

LBILLANT04

LANTERNS

OUTDOOR - LANTERNS - LBILLANT04

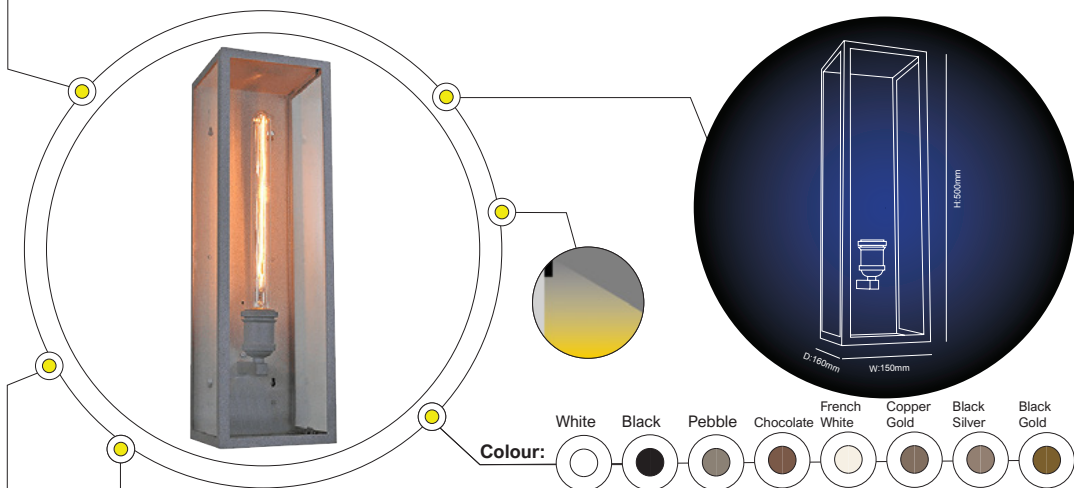

+ IP 65



5 YRS

PHYSICAL DATA

FEATURES

- Material: Powder-coated aluminium frame
- The LBILLANT04 is a contemporary indoor/outdoor 3-panel rectangular wall lantern with clear glass
- Ideal for outdoor coastal areas

OPTIONS & ACCESSORIES

- Eight colour finishes to choose from

MOUNTING

Surface

APPLICATION AREAS

Indoor, Outdoor, Commercial, Residential, Retail, Hospitality

TECHNICAL DATA

LBILLANT04

LAMP HOLDER	E27
VOLTAGE	230V 50Hz
DIMENSIONS	W:150 x D:160 x H:500mm

LAMP DATA

G780A

LAMP	AMBER CARBON FILAMENT
SHAPE	TUBULAR
BASE	E27
DIMMABLE	YES
TOTAL POWER (W)	60W
RATED LIFE (HRS)	3000HRS
OPERATING VOLTAGE	220-240V
DIMENSIONS	D:φ30 x L:295mm



PLEASE NOTE

Lamp specifications and lamp warranties may differ

LBILLANT05

LANTERNS

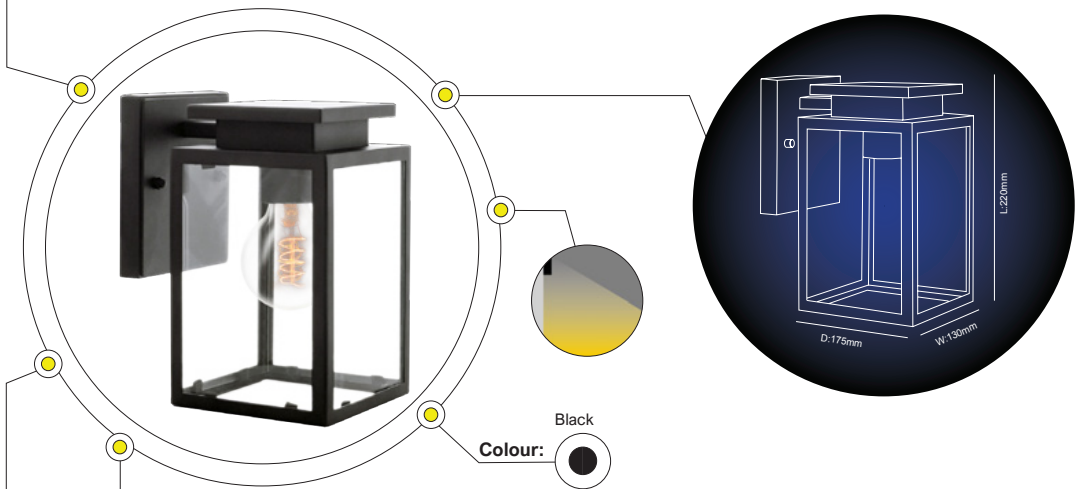

+ IP 44



✓ 1YR

PHYSICAL DATA

FEATURES

- Material: Iron (non-coastal)
- Matt black with clear glass

MOUNTING

Surface

APPLICATION AREAS

Indoor, Outdoor, Commercial, Residential, Retail, Hospitality

TECHNICAL DATA

LBILLANT05

LAMP HOLDER	E27 60W
VOLTAGE	230V 60W
DIMENSIONS	L:220 x W:130 x D:175mm

LAMP DATA

HX-LSG80-4W

LAMP	LED SPIRAL FILAMENT
	CLEAR GLASS
SHAPE	BALL SPIRAL BULB
BASE	E27
DIMMABLE	YES - DIMMABLE
TOTAL POWER (W)	4W
CCT (K)	2200K
CRI (RA)	80
RATED LIFE (HRS)	15 000HRS
OPERATING VOLTAGE	240V



PLEASE NOTE

Lamp specifications and lamp warranties may differ

> **BOLLARDS**

COMMERCIAL & ARCHITECTURAL

OUTDOOR - BOLLARDS



CRU H DOUBLE

BOLLARDS

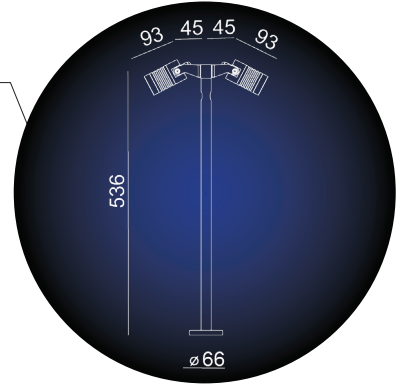
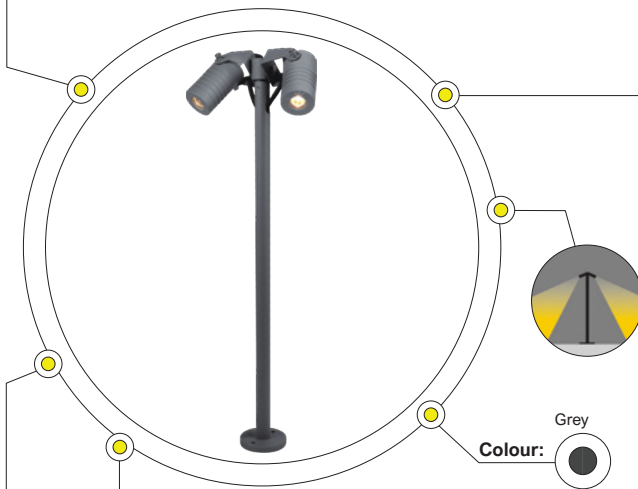

+ IP
65



LOA

✓
3 YRS

PHYSICAL DATA

FEATURES

- Material: Aluminium
- The CRU H DOUBLE is a mini spot that is sandblasted with an anodized treatment that offers a superior weatherproof treatment for the outdoors
- Free adjustment of projecting angle

OPTIONS & ACCESSORIES

- The CRU H is available with a single or double light

- The CRU is available with base plate or spike for selection
- The CRU is available in a 24V DC option

MOUNTING

Surface

APPLICATION AREAS

Outdoor, Commercial, Residential, Retail, Hospitality

TECHNICAL DATA

LF717911A

LAMP	LED
TOTAL POWER (W)	2 x 2.4W
SYSTEM OUTPUT (LM)	177LM
CCT (K)	2700 / 3000 / 4000K
CRI (Ra)	80
BEAM ANGLE	12 / 30°
OPERATING VOLTAGE-VAC	100-240V
SOURCE POWER (W)	2 x 3.6W
SOURCE OUTPUT (LM)	260LM
DIMENSIONS	D:φ66 x H:536mm

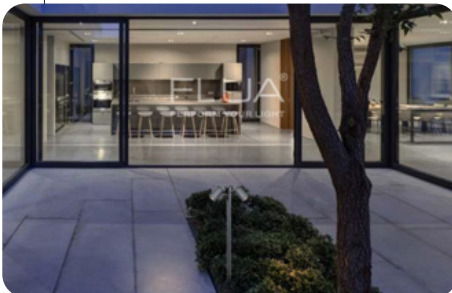

E&OE MAY OCCUR

ETERNITY SINGLE

BOLLARDS

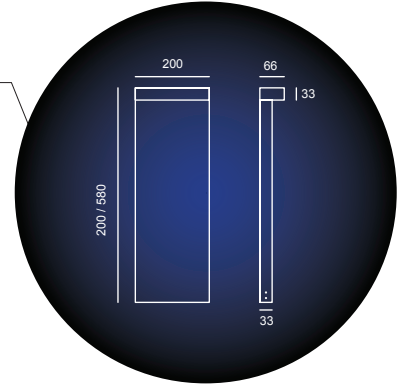
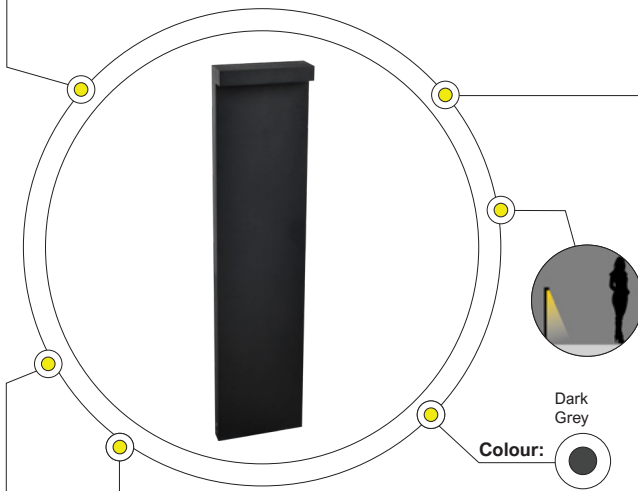

Dark Grey

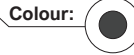

+ IP 65



LOA



PHYSICAL DATA

FEATURES

- Material : Aluminium
- The ETERNITY is your perfect outdoor companion when it comes to creating a warm and cosy atmosphere
- The 2 different heights make them useful in many applications
- On/Off driver built in

- The ETERNITY is available 2 different heights for selection
- The ETERNITY DOUBLE, with two light beams, is also available for selection

MOUNTING: Surface

APPLICATION AREAS

Outdoor, Commercial, Residential, Retail, Hospitality

OPTIONS & ACCESSORIES

TECHNICAL DATA

LF728814

LF728914

LAMP	LED	LED
TOTAL POWER (W)	11W	11W
SYSTEM OUTPUT (LM)	248LM	248LM
CCT (K)	2700 / 3000 / 4000K	2700 / 3000 / 4000K
CRI (Ra)	80	80
BEAM ANGLE	Flood	Flood
OPERATING VOLTAGE-VAC	220-240V	220-240V
DIMENSIONS	L:200 x W:33 x H:200mm	L:200 x W:33 x H:580mm



E&OE MAY OCCUR

ETERNITY DOUBLE

BOLLARDS

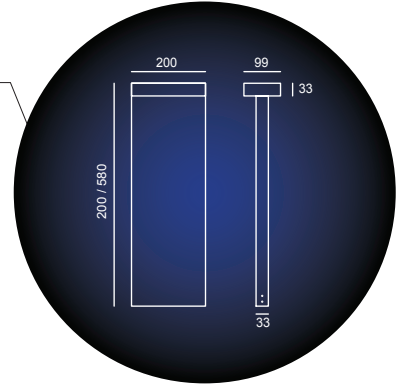
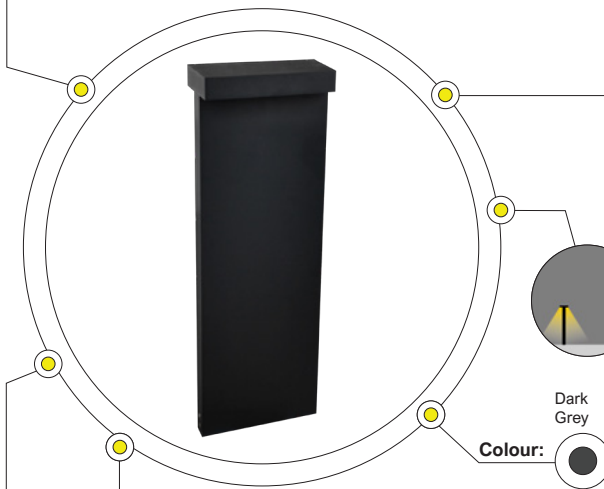

+ IP 65



LOA

2 YRS

PHYSICAL DATA

FEATURES

- Material : Aluminium
- The ETERNITY is your perfect outdoor companion when it comes to creating a warm and cosy atmosphere
- The 2 different heights make them useful in many applications
- On/Off driver built in

- The ETERNITY is available 2 different heights for selection
- The ETERNITY DOUBLE, with two light beams, is also available for selection

MOUNTING: Surface

APPLICATION AREAS

Outdoor, Commercial, Residential, Retail, Hospitality

OPTIONS & ACCESSORIES

TECHNICAL DATA

LF729124

LF729224

NAME	D200	D600
LAMP	LED	LED
TOTAL POWER (W)	2 x 9.5W	2 x 9.5W
SYSTEM OUTPUT (LM)	631LM	631LM
CCT (K)	2700 / 3000 / 4000K	2700 / 3000 / 4000K
CRI (Ra)	80	80
BEAM ANGLE	Flood	Flood
OPERATING VOLTAGE-VAC	220-240V	220-240V
CURRENT (MA)	500MA	500MA
FLICKER FACTOR	100HZ / 1.673%	100HZ / 1.673%
DIMENSIONS	L:200 x W:99 x H:200mm	L:200 x W:99 x H:580mm

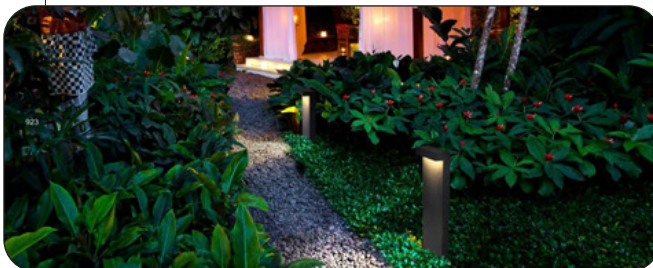

E&OE MAY OCCUR

JOY

BOLLARDS

OUTDOOR - BOLLARDS - JOY

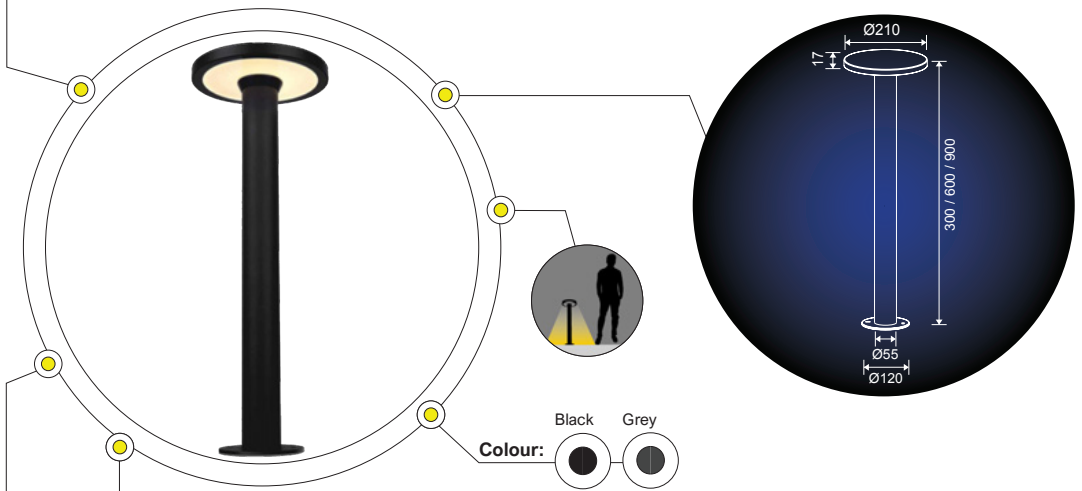

+ IP 65



LOA

3 YRS

ldt

PHYSICAL DATA

FEATURES

- Material: Aluminium
- Beautiful simple bollard boasts an ultra thin aluminium disc that illuminates the outdoors beautifully

MOUNTING

Surface

APPLICATION AREAS

Outdoor, Commercial, Residential, Retail, Hospitality

OPTIONS & ACCESSORIES

- Available in three heights: 300mm, 600mm and 900mm

TECHNICAL DATA

LF725514

LF725214

LF725414

LAMP	LED	LED	LED
TOTAL POWER (W)	15W	15W	15W
SYSTEM OUTPUT (LM)	600LM	600LM	600LM
CCT (K)	2700 / 3000 / 4000K	2700 / 3000 / 4000K	2700 / 3000 / 4000K
CRI (Ra)	80	80	80
BEAM ANGLE	180°	180°	180°
OPERATING VOLTAGE-VAC	220-240V	220-240V	220-240V
SOURCE POWER (W)	17W	17W	17W
CURRENT (MA)	500MA	500MA	500MA
FLICKER FACTOR	100HZ / 1.63%	100HZ / 1.63%	100HZ / 1.63%
DIMENSIONS	D:φ210 x H:300mm	D:φ210 x H:600mm	D:φ210 x H:900mm

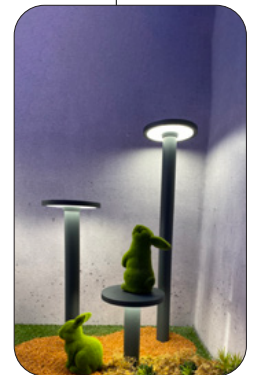

CD / KLM

● C0 - C180

● C90 - C270

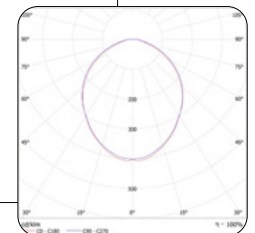

E&OE MAY OCCUR

WAY R

BOLLARDS

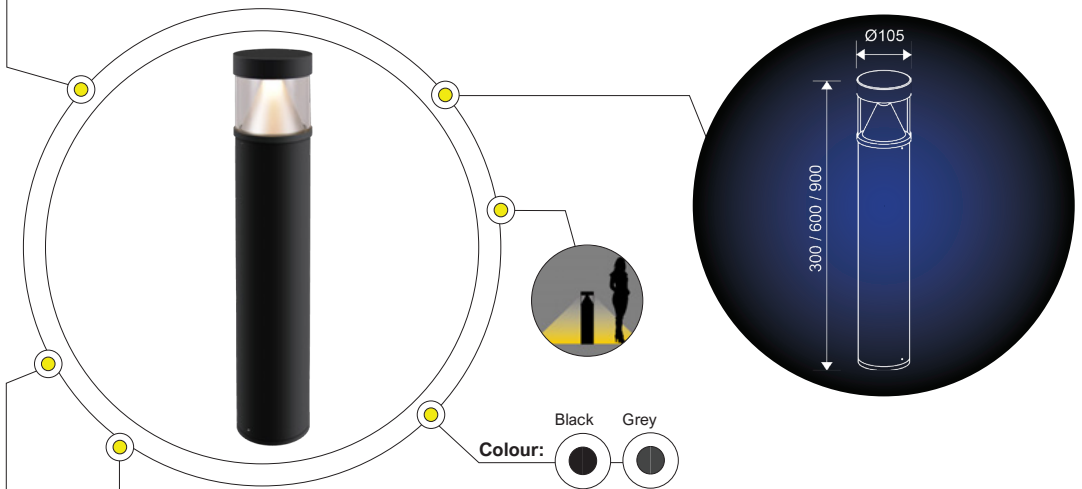

+ IP 65



LOA

3 YRS

ldt

PHYSICAL DATA

FEATURES

- Material: Aluminium
- Conical reflector - provides diffused 360° light effect
- Simple and elegant design

MOUNTING

Surface

APPLICATION AREAS

Outdoor, Commercial, Residential, Retail, Hospitality

OPTIONS & ACCESSORIES

- Available in three heights: 300mm, 600mm and 900mm

TECHNICAL DATA

LF724414

LF722814

LF724614

LAMP	LED	LED	LED
TOTAL POWER (W)	7.3W	7.3W	7.3W
SYSTEM OUTPUT (LM)	291LM	291LM	291LM
CCT (K)	2700 / 3000 / 4000K	2700 / 3000 / 4000K	2700 / 3000 / 4000K
CRI (Ra)	80	80	80
BEAM ANGLE	180°	180°	180°
OPERATING VOLTAGE-VAC	100-240V	100-240V	100-240V
SOURCE POWER (W)	7.7W	7.7W	7.7W
WEIGHT (KG)	1.35KG	1.96KG	2.37KG
DIMENSIONS	D:φ105 x H:300mm	D:φ105 x H:600mm	D:φ105 x H:900mm

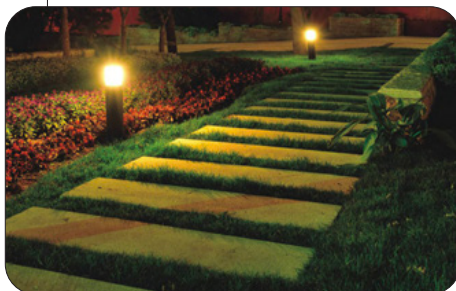

CD / KLM

● C0 - C180

● C90 - C270

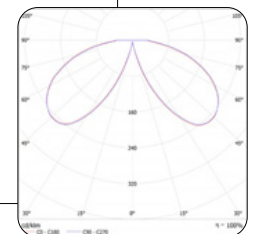

E&OE MAY OCCUR

LBOL1012

BOLLARDS

OUTDOOR - POST TOPS - LBOL1012

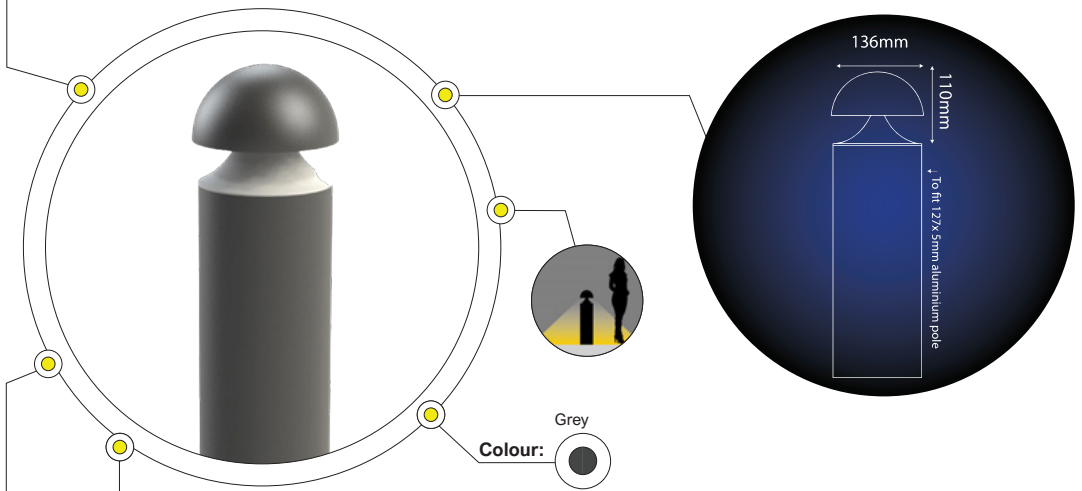

+ IP 66



5 YRS

ldt

PHYSICAL DATA

FEATURES

- Material: Body is glass filled polypropylene, lens is clear or frosted acrylic
- Internally mounted Tridonic, Helvar or TCI
- Recommended mounting height 600mm or 1000mm

- 76mm diameter pole available

MOUNTING

Surface

APPLICATION AREAS

Outdoor, Commercial, Residential, Retail, Hospitality

OPTIONS & ACCESSORIES

- Dali, 1-10V, DMX, Triac dimmable with correct gear

TECHNICAL DATA

LBOL1012

LAMP	LED
TOTAL POWER (W)	12W
SYSTEM OUTPUT (LM)	1500LM
CCT (K)	3000 / 4000 / 5000K
CRI (Ra)	>82
OPERATING VOLTAGE-VAC	230V
OPERATING TEMP °C	-20°C TO 40°C
RATED LIFE (HRS)	50 000HRS
DIMENSIONS	D:φ136 x H:110mm

- CD / KLM
- C0 - C180
 - C90 - C270

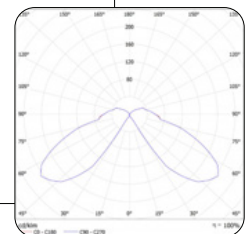

E&OE MAY OCCUR

> FOOTLIGHTS

COMMERCIAL & ARCHITECTURAL



OUTDOOR - FOOTLIGHTS

Project Ocean View / Lighting Design: Chanel van Vuuren / Photography: Archigraphy

PACE LONG 2

FOOTLIGHTS

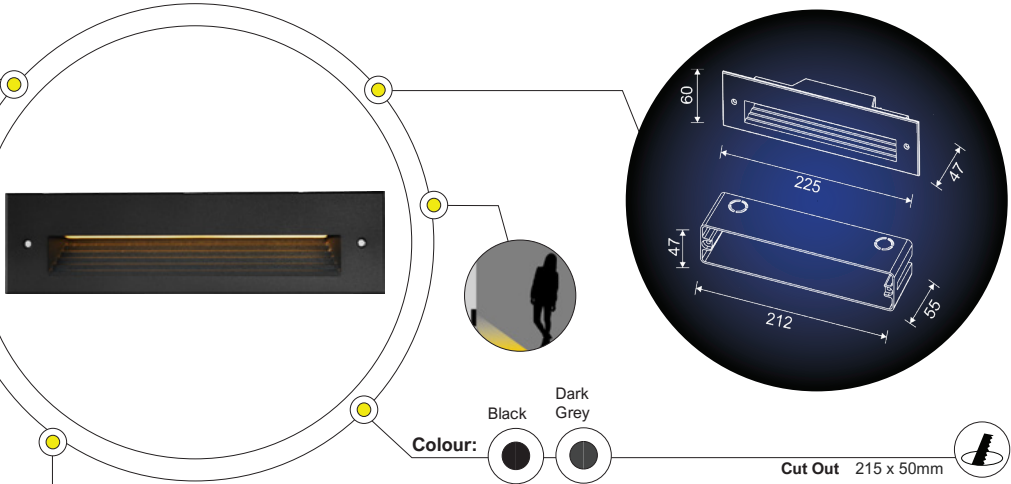

PHYSICAL DATA

FEATURES

- Material: Aluminium
- The PACE is a series of recessed luminaires that offer glare-free illumination with a special shielded design at a low mounting height. The PACE LONG offers a lovely soft and comfortable lighting

rectangular shapes with either half-shielded or grille surface cover options for selection

- The PACE LONG 1 and PACE LONG 3 are available in a stainless steel version

OPTIONS & ACCESSORIES

- The PACE range is available in both round, square and

MOUNTING: Recessed

APPLICATION AREAS: Outdoor, Indoor, Commercial, Residential, Retail, Hospitality

+ IP 65



LOA

3 YRS

ldt

TECHNICAL DATA

LF417214

LAMP	LED
TOTAL POWER (W)	2.2W
SYSTEM OUTPUT (LM)	30LM
CCT (K)	2700 / 3000 / 4000K
CRI (Ra)	80
OPERATING VOLTAGE-VAC	100-240V
SOURCE POWER (W)	4W
CURRENT (MA)	700MA
FLICKER FACTOR	41.15HZ / 0.57%
WEIGHT (KG)	0.51KG
DIMENSIONS	L:225 x W:49 x H:60mm
CUT OUT	215 x 50mm

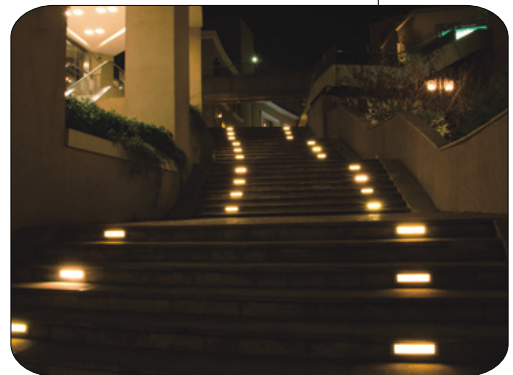

CD / KLM

● C0 - C180

● C90 - C270

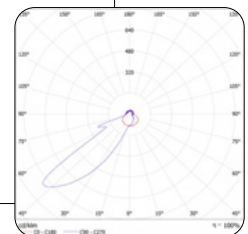

E&OE MAY OCCUR

PACE SQUARED

FOOTLIGHTS

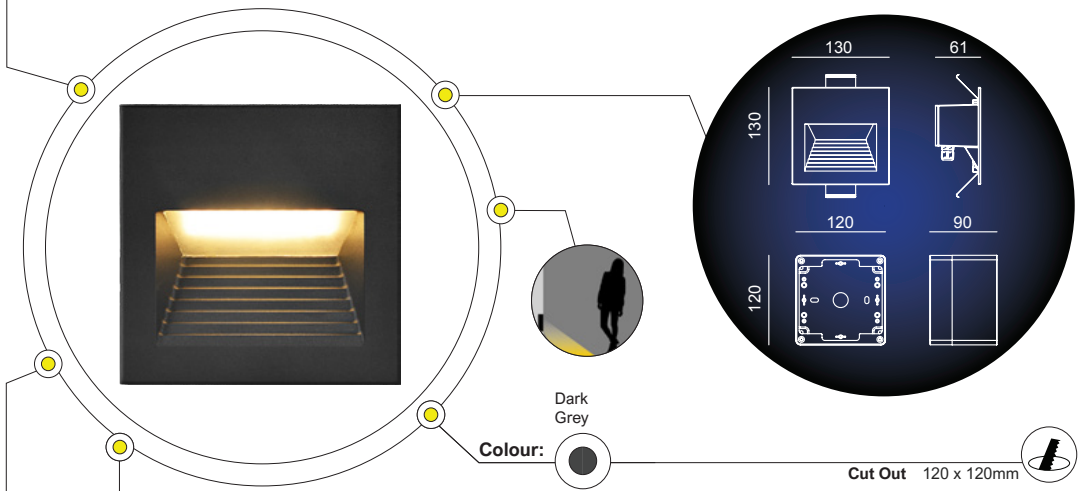

+ IP 65



LOA

3 YRS

ldt

PHYSICAL DATA

FEATURES

- Material: Aluminium
- The PACE is a series of recessed luminaires that offer glare-free illumination with a special shielded design at a low mounting height. The PACE SQUARED offers a lovely soft and comfortable lighting experience

OPTIONS & ACCESSORIES

- The PACE range is available in both round, square and

rectangular shapes with either half-shielded or grille surface cover options for selection

- The PACE LONG 1 and PACE LONG 3 are available in a stainless steel version

MOUNTING: Recessed

APPLICATION AREAS: Outdoor, Indoor, Commercial, Residential, Retail, Hospitality

TECHNICAL DATA

LF417014

LAMP	LED
TOTAL POWER (W)	2.25W
SYSTEM OUTPUT (LM)	110LM
CCT (K)	2700 / 3000 / 4000K
CRI (Ra)	80
OPERATING VOLTAGE-VAC	100-240V
SOURCE POWER (W)	4W
CURRENT (MA)	700MA
FLICKER FACTOR	41.15HZ / 0.57%
WEIGHT (KG)	0.74KG
DIMENSIONS	L:130 x W:130 x H:61mm
CUT OUT	121 x 121mm

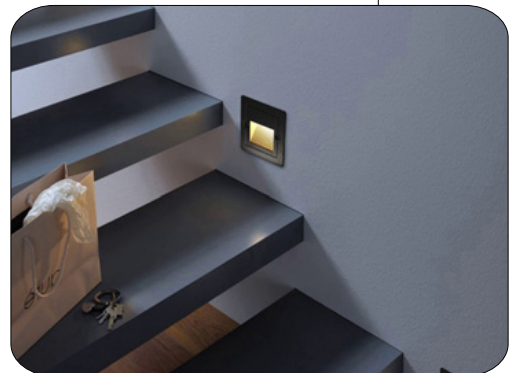

- CD / KLM
- C0 - C180
- C90 - C270

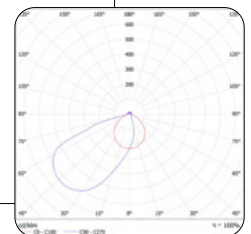

E&OE MAY OCCUR

SLIDE IP AISI316

FOOTLIGHTS

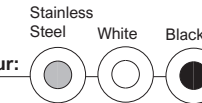
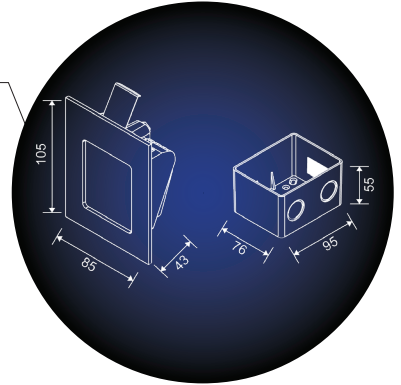
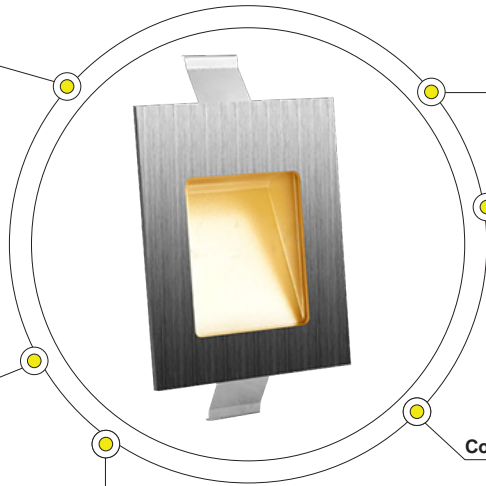

Colour:

Cut Out 75 x 95mm



PHYSICAL DATA

FEATURES

- Material : Stainless Steel (LF413914A) and aluminium (LF411214A)
- SLIDE is a wall recessed luminaire, SLIDE is a perfect guidance light.
- Be it in a corridor or as a safety light for the steps at night, SLIDE does the trick

- The SLIDE is available in a square, rectangular shapes and with IP20 (non-waterproof) and IP65 (waterproof) options for selection

MOUNTING: Recessed

APPLICATION AREAS

Outdoor, Indoor, Commercial, Residential, Retail, Hospitality

OPTIONS & ACCESSORIES

+ IP 65



LOA

5 YRS

ldt

TECHNICAL DATA

LF413914A

LF411214A

LAMP	LED	LED
MATERIAL	STAINLESS STEEL	ALUMINIUM
TOTAL POWER (W)	3W	3W
SYSTEM OUTPUT (LM)	215LM	215LM
CCT (K)	2700 / 3000 / 3500 / 4000K	2700 / 3000 / 3500 / 4000K
CRI (Ra)	80	80
OPERATING VOLTAGE-VAC	100-240V	100-240V
SOURCE POWER (W)	5.1W	5.1W
SOURCE OUTPUT (LM)	380LM	380LM
CURRENT (MA)	350MA	350MA
FLICKER FACTOR	1935.48HZ / 6.15%	1935.48HZ / 6.15%
WEIGHT (KG)	0.37KG	0.37KG
DIMENSIONS	L:85 x H:105 x W:43mm	L:85 x H:105 x W:43mm
CUT OUT	75 x 95 x 55mm	75 x 95 x 55mm

Please note: Minimum Order Quantities apply

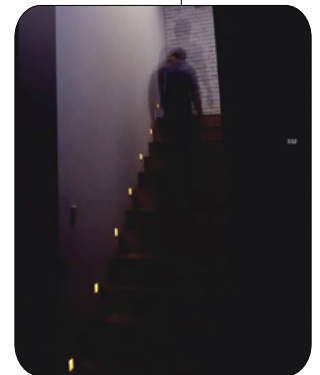

CD / KLM

● C0 - C180

● C90 - C270

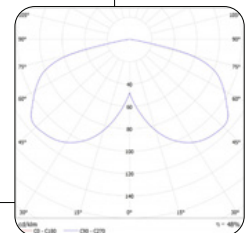

E&OE MAY OCCUR

TEAR

FOOTLIGHTS

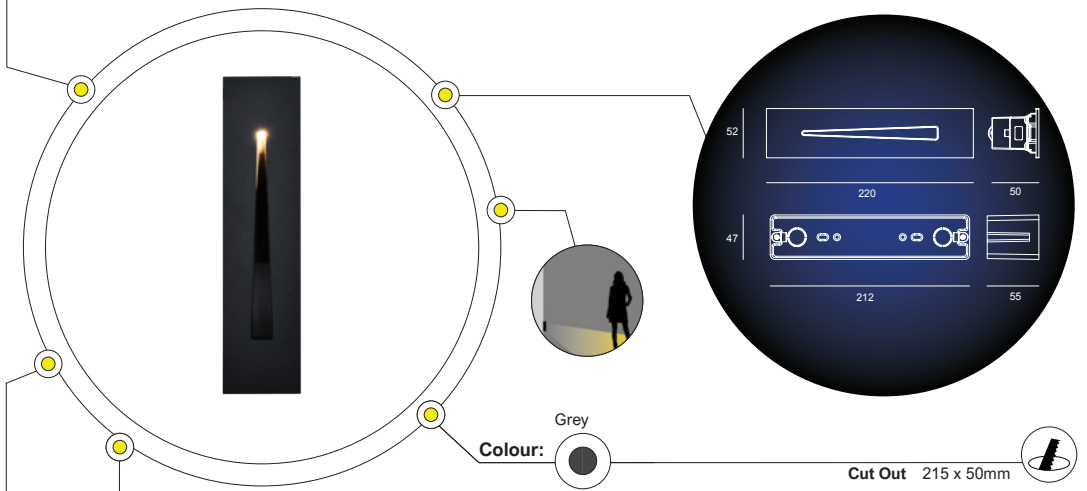

+ IP 65



LOA

3 YRS

ldt

PHYSICAL DATA

FEATURES

- Material : Aluminium
- The TEAR, with its triangular shape is a modern guidance light that creates a slender light beam on the floor
- Driver: ON/OFF

MOUNTING

Recessed

APPLICATION AREAS

Outdoor, Commercial, Residential, Retail, Hospitality

TECHNICAL DATA

LF430717A

LAMP	LED
TOTAL POWER (W)	2.6W
SYSTEM OUTPUT (LM)	10LM
CCT (K)	2700 / 3000 / 4000K
CRI (Ra)	80
OPERATING VOLTAGE-VAC	100-240V
SOURCE POWER (W)	4.2W
SOURCE OUTPUT (LM)	199LM
CURRENT (MA)	700MA
FLICKER FACTOR	243.9HZ / 2.36%
WEIGHT (KG)	0.5KG
HOUSING DIMENSIONS	H:220 x L:52 x W:55mm
DIMENSIONS	H:212 x L:47 x W:55mm
CUT OUT	L:215 x W:50mm

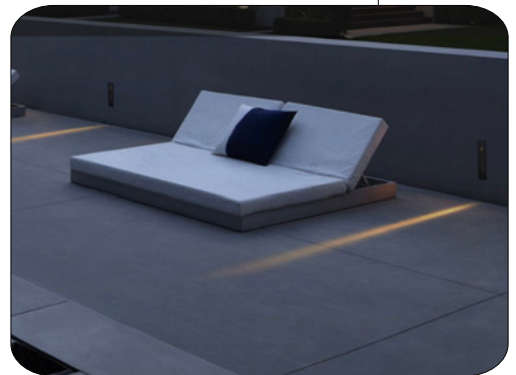

- CD / KLM
- C0 - C180
 - C90 - C270

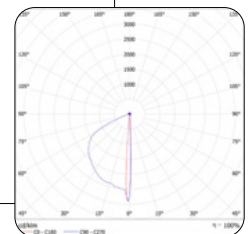

E&OE MAY OCCUR

TONE IN

FOOTLIGHTS

OUTDOOR - FOOTLIGHTS - TONE IN

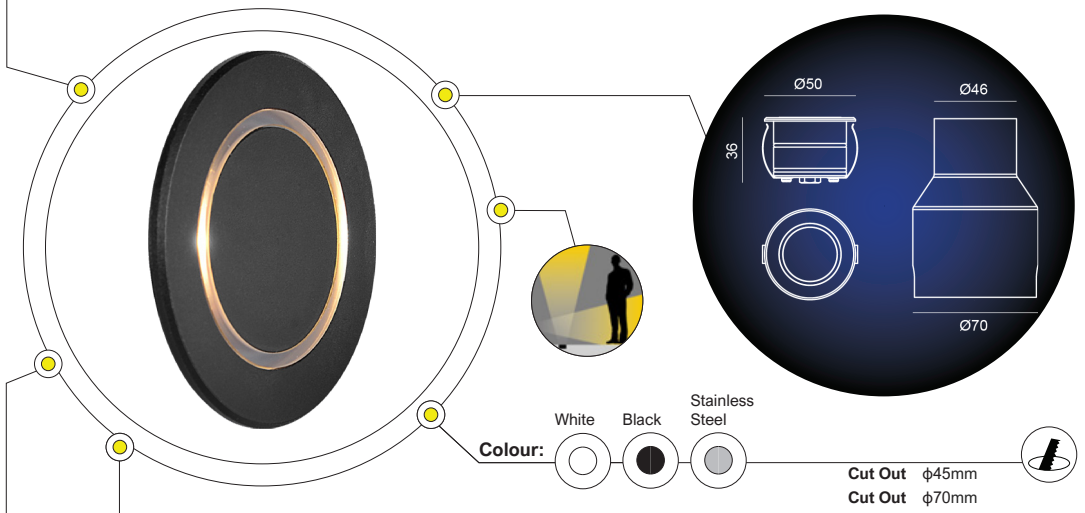

- + IP 65
- LOA
- 5 YRS
- ldt

PHYSICAL DATA

FEATURES

- Material : Aluminium
- The TONE IN is an excellent recessed guidance light in round-shaped frame
- It's unique and popular design of the inner ring creates soft and delicate lighting

available in stainless steel for selection

MOUNTING: Recessed, Wall and Floor

APPLICATION AREAS

Outdoor, Commercial, Residential, Retail, Hospitality

OPTIONS & ACCESSORIES

- The TONE IN AISI316 DC is a 24V 1.5W option

TECHNICAL DATA

LF413011A

LAMP	LED
TOTAL POWER (W)	2.1W
SYSTEM OUTPUT (LM)	15LM
CCT (K)	3000K
CRI (Ra)	80
OPERATING VOLTAGE-VAC	100-240V
SOURCE POWER (W)	4W
SOURCE OUTPUT (LM)	100LM
CURRENT (MA)	350MA
FLICKER FACTOR	1935.48HZ / 6.15%
WEIGHT (KG)	0.35KG
HOUSING DIMENSIONS	D:φ70 x H:36mm
DIMENSIONS	D:φ50 x H:36mm
CUT OUT	D:φ45mm / D:φ70mm

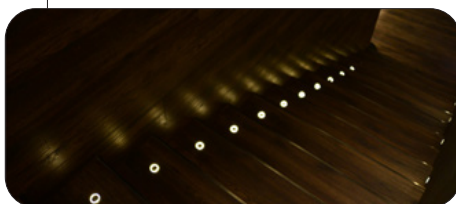
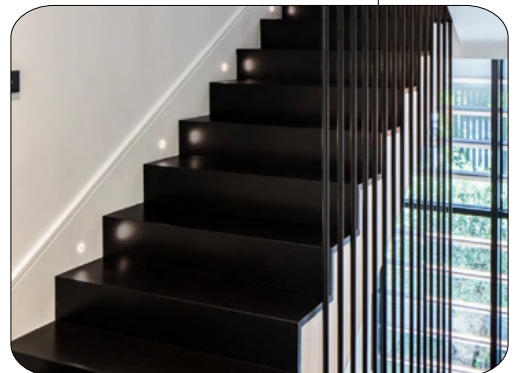

- CD / KLM
- C0 - C180
 - C90 - C270

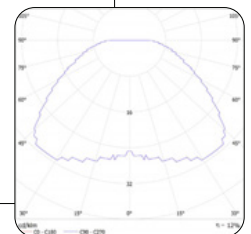

E&OE MAY OCCUR

TWILIGHT RECTANGULAR

FOOTLIGHTS

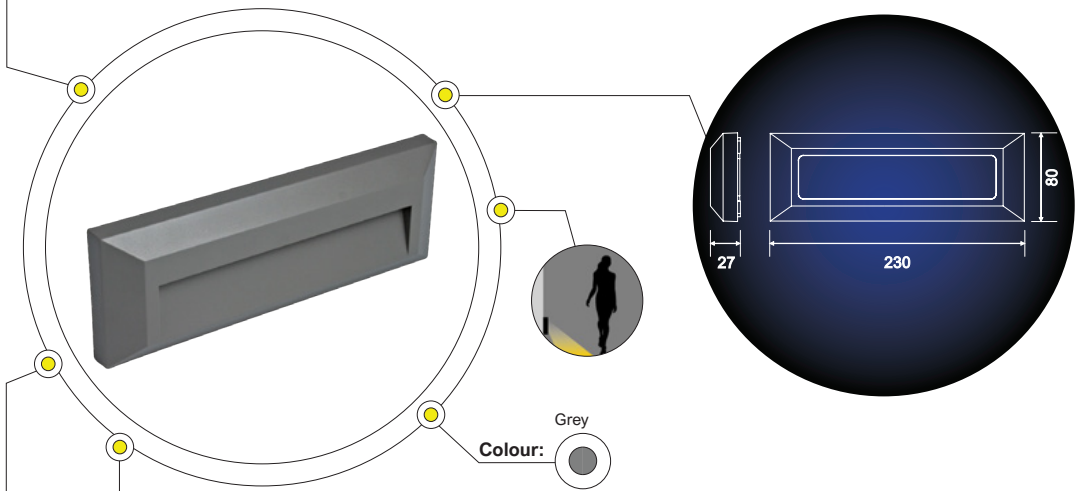

+ IP
65



LOA

3 YRS

ldt

PHYSICAL DATA

FEATURES

- Material: Base and diffusers manufactured from UV stabilised polycarbonate
- Clip-on cover with no exposed screws
- ABS, weather resistant housing - Great for coastal applications as will not rust and discolour walls
- Slim design surface mounted - no cut out holes required
- High impact rating, high-quality, high-efficiency luminaire

- Integral driver

OPTIONS & ACCESSORIES

- Choice of circular, square, and rectangular vertical or horizontal designs for selection

MOUNTING: Surface

APPLICATION AREAS: Outdoor, Commercial, Residential, Retail, Hospitality

TECHNICAL DATA

RTW0230RGL24

LAMP	LED
TOTAL POWER (W)	1.7W
SYSTEM OUTPUT (LM)	80LM
EFFICACY (LM/W)	48
CCT (K)	3000K
CRI (RA)	80
BEAM ANGLE	35°
OPERATING VOLTAGE-VAC	220-240V
OPERATING TEMP (°C)	-20°C to 40°C
RATED LIFE (HRS)	30 000HRS
POWER FACTOR	0.55
ILLUM @ 1M (LUX)	72
IMPACT RATING (IK)	IK07
WEIGHT (KG)	0.22KG
DIMENSIONS	W:230 x D:27 x L:80mm



- CD / KLM
- C0 - C180
 - C90 - C270

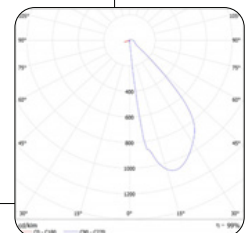

E&OE MAY OCCUR

TWILIGHT ROUND

FOOTLIGHTS

OUTDOOR - FOOTLIGHTS - TWILIGHT ROUND

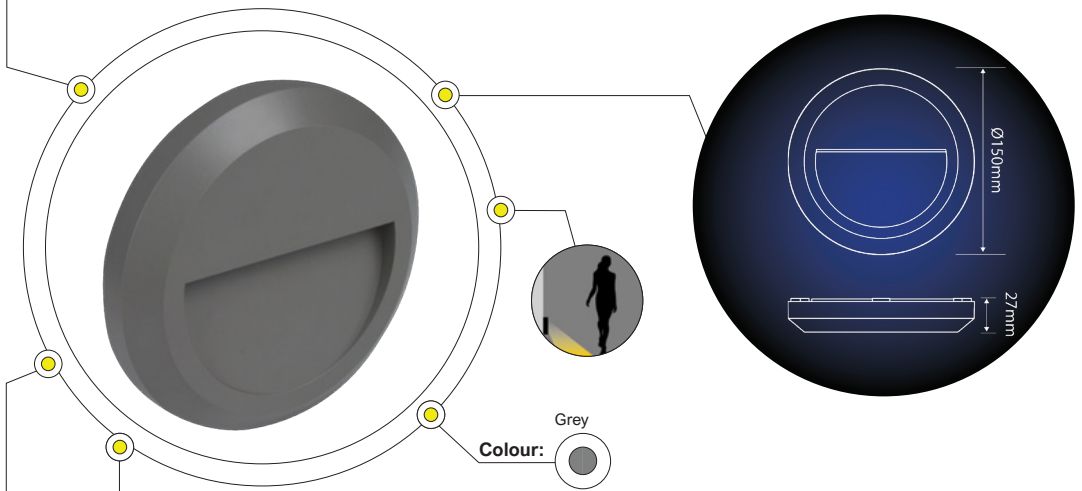

+ IP
65



LOA

✓
2 YRS

ldt

PHYSICAL DATA

FEATURES

- Material: Base and diffusers manufactured from UV stabilised polycarbonate
- Clip-on cover with no exposed screws
- ABS, weather resistant housing - Great for coastal applications as will not rust and discolour walls
- Slim design surface mounted - no cut out holes required
- High impact rating, high-quality, high-efficiency luminaire

- Integral driver

OPTIONS & ACCESSORIES

- Choice of circular, square, and rectangular vertical or horizontal designs for selection

MOUNTING: Surface

APPLICATION AREAS: Outdoor, Commercial, Residential, Retail, Hospitality

TECHNICAL DATA

RTW0230C-24

LAMP	LED
TOTAL POWER (W)	1.8W
SYSTEM OUTPUT (LM)	80LM
EFFICACY (LM/W)	47
CCT (K)	3000K
CRI (RA)	80
BEAM ANGLE	40°
OPERATING VOLTAGE-VAC	220-240V
OPERATING TEMP (°C)	-20°C to 40°C
RATED LIFE (HRS)	30 000HRS
POWER FACTOR	0.55
ILLUM @ 1M (LUX)	76
IMPACT RATING (IK)	IK07
WEIGHT (KG)	0.19KG
DIMENSIONS	D:φ150 x D:27mm

- CD / KLM
- C0 - C180
 - C90 - C270

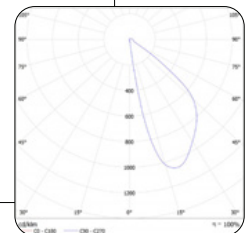

E&OE MAY OCCUR

TWILIGHT SQUARE

FOOTLIGHTS

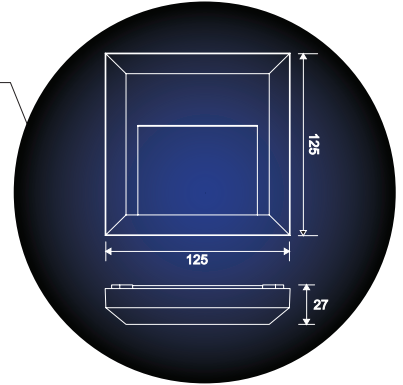
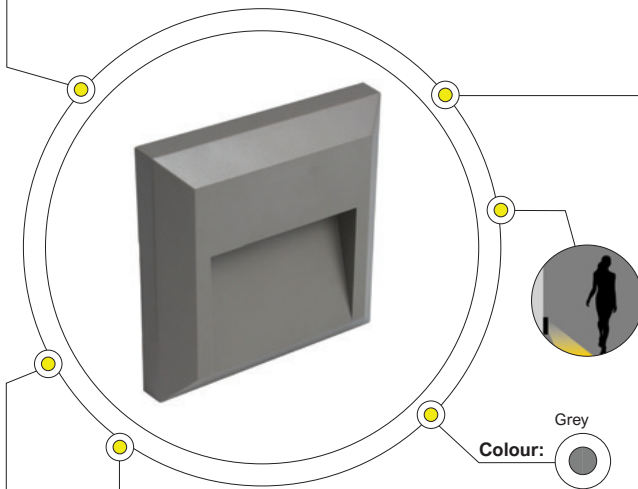

Colour: Grey

+ IP 65



LOA

2 YRS

ldt

PHYSICAL DATA

FEATURES

- Material: Base and diffusers manufactured from UV stabilised polycarbonate
- Clip-on cover with no exposed screws
- ABS, weather resistant housing - Great for coastal applications as will not rust and discolour walls
- Slim design surface mounted - no cut out holes required
- High impact rating, high-quality, high-efficiency luminaire

- Integral driver

OPTIONS & ACCESSORIES

- Choice of circular, square, and rectangular vertical or horizontal designs for selection

MOUNTING: Surface

APPLICATION AREAS: Outdoor, Commercial, Residential, Retail, Hospitality

TECHNICAL DATA

RTW0130SQ-24

LAMP	LED
TOTAL POWER (W)	1.5W
SYSTEM OUTPUT (LM)	60LM
EFFICACY (LM/W)	46
CCT (K)	3000K
CRI (RA)	80
BEAM ANGLE	50°
OPERATING VOLTAGE-VAC	220-240V
OPERATING TEMP (°C)	-20°C to 40°C
RATED LIFE (HRS)	30 000HRS
POWER FACTOR	0.55
IMPACT RATING (IK)	IK07
WEIGHT (KG)	0.18KG
DIMENSIONS	W:125 x D:27 x L:125mm



- CD / KLM
- C0 - C180
 - C90 - C270

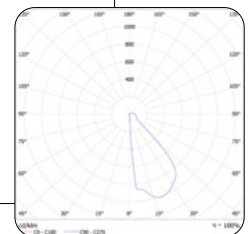

E&OE MAY OCCUR

LFL04 CTC FOOTLIGHT

FOOTLIGHTS

OUTDOOR - FOOTLIGHTS - LFL04

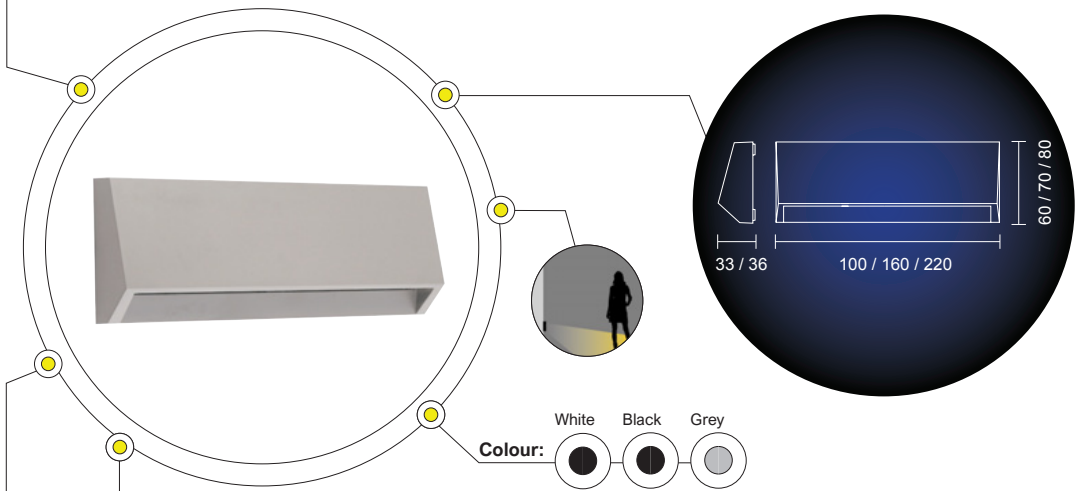

+ IP 65



✓ 1 YR



COLOUR SELECTABLE

PHYSICAL DATA

FEATURES

- Material: ABS Polycarbonate
- CTC footlight with ABS body and polycarbonate diffuser
- CCT (K) colour temperature selectable
- Includes LED driver
- Coastal quality

- Available in small, medium and large options to select from

MOUNTING

Surface

APPLICATION AREAS

Indoor, Outdoor, Commercial, Residential, Hospitality, Retail

OPTIONS & ACCESSORIES

TECHNICAL DATA

LFL04 2W

LFL04 4W

LFL04 5W

LAMP	LED	LED	LED
TOTAL POWER (W)	2W	3.8W	5W
SYSTEM OUTPUT	100LM	200LM	250LM
CCT (K)	3000K or 4000K or 6500K	3000K or 4000K or 6500K	3000K or 4000K or 6500K
OPERATING VOLTAGE-VAC	230V	230V	230V
OPERATING TEMP °C	-20°C to +50°C	-20°C to +50°C	-20°C to +50°C
DIMENSIONS	W:100 x H:60 x D:33mm	W:160 x H:70 x D:33mm	W:220 x H:80 x D:36mm



- CD / KLM
- C0 - C180
 - C90 - C270

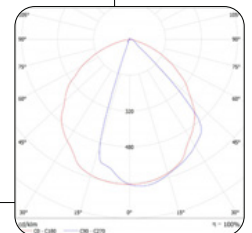

E&OE MAY OCCUR

> FLOODLIGHTS

COMMERCIAL & ARCHITECTURAL



COSMIC

FLOODLIGHTS

OUTDOOR - FLOODLIGHTS - COSMIC

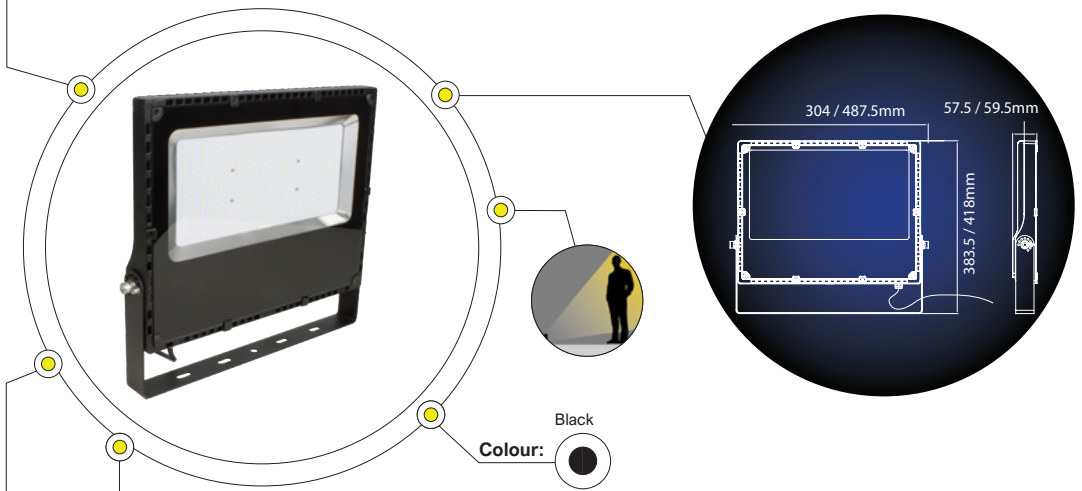

+ IP 65



LOA

3 YRS

ldt



PHYSICAL DATA

FEATURES

- Material: Black powder coated die-cast aluminium body with tempered glass diffuser
- Cold Rolled and formed steel (SPCC) mounting bracket
- Stainless steel bracket screws FR-4 PCB material
- Die-cast aluminium housing providing optimal heat dissipation and high resistance to weather conditions
- Self regulating valve on the fitting to stop the condensation
- High-impact rating of IK07 and High efficacy of 112lm/W
- Pre-wired with 1m of rubber flex and pre-drilled mounting

bracket with 180° adjustable angle

- No warm up or cool down period required by LED
- Suitable for switching by PIR, Microwave or Photocell

MOUNTING

Surface

APPLICATION AREAS

Outdoor, Commercial, Residential, Retail, Hospitality

TECHNICAL DATA

RCM10040-04

RCM15040-04

RCM20040-04

LAMP	LED	LED	LED
TOTAL POWER (W)	94.6W	127W	174.7W
SYSTEM OUTPUT (LM)	11 490LM	18 110LM	24 770LM
EFFICACY (LM/W)	121	143	141
CCT (K)	4000K	4000K	4000K
CRI (RA)	80	80	80
BEAM ANGLE	110°	110°	110°
OPERATING VOLTAGE	220-240V	220-240V	220-240V
OPERATING TEMP (°C)	-20°C to 40°C	-20°C to 40°C	-20°C to 40°C
RATED LIFE (HRS)	50 000HRS	50 000HRS	50 000HRS
POWER FACTOR	0.97	0.97	0.97
ILLUM @ 1M (LUX)	4210	6520	8920
WEIGHT (KG)	3.5KG	5.9KG	6KG
DIMENSIONS	L:304 x W:57.5 x H:383.5mm	L:487.5 x W:59.5 x H:418mm	L:487.5 x W:59.5 x H:418mm

CD / KLM

● C0 - C180

● C90 - C270

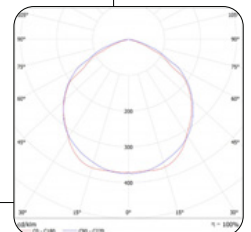

E&OE MAY OCCUR

HILUME

FLOODLIGHTS

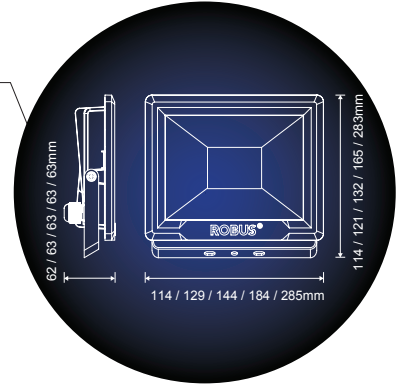

+ IP 65



LOA



ldt



PHYSICAL DATA

FEATURES

- Material: Powder-coated die-cast aluminium body and polycarbonate bezel
- Tempered glass frosted diffuser, galvanised mounting bracket and stainless steel external fixings
- Die cast aluminium housing providing optimal heat dissipation and high resistance to weather conditions
- Tempered glass providing high impact rating of IK05
- Pre-wired with 1m of rubber flex and has pre-drilled angled mounting bracket with 180° adjustable angle

- Suitable for switching by PIR, Microwave or Photocell

OPTIONS & ACCESSORIES

- HILUME with built-in PIR available for selection

MOUNTING

Surface

APPLICATION AREAS

Outdoor, Commercial, Residential, Retail, Hospitality

TECHNICAL DATA

RHL1030/1040-04

RHL2030/2040-04

RHL3030/3040-04

LAMP	LED	LED	LED
TOTAL POWER (W)	11.1 / 10.6W	20.4 / 19.7W	29.2 / 28W
SYSTEM OUTPUT (LM)	960 / 980LM	1640 / 1730LM	2110 / 2190LM
EFFICACY (LM/W)	87 / 93	87 / 88	75 / 78
CCT (K)	3000 / 4000K	3000 / 4000K	3000 / 4000K
CRI (RA)	80	80	80
BEAM ANGLE	100°	100°	100°
OPERATING VOLTAGE	220-240V	220-240V	220-240V
OPERATING TEMP (°C)	-20°C to 40°C	-20°C to 40°C	-20°C to 40°C
RATED LIFE (HRS)	20 000HRS	20 000HRS	20 000HRS
POWER FACTOR	0.6	0.6	0.99 / 0.9
ILLUM @ 1M (LUX)	420 / 430	720 / 760	920
WEIGHT (KG)	0.34KG	0.4KG	0.48KG
DIMENSIONS	L:114 x W:62 x H:144mm	L:129 x W:63 x H:121mm	L:144 x W:63 x H:132mm

- CD / KLM
- C0 - C180
 - C90 - C270

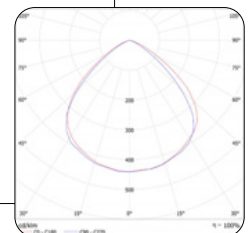

E&OE MAY OCCUR

HILUME PIR

FLOODLIGHTS

OUTDOOR - FLOODLIGHTS - HILUME PIR

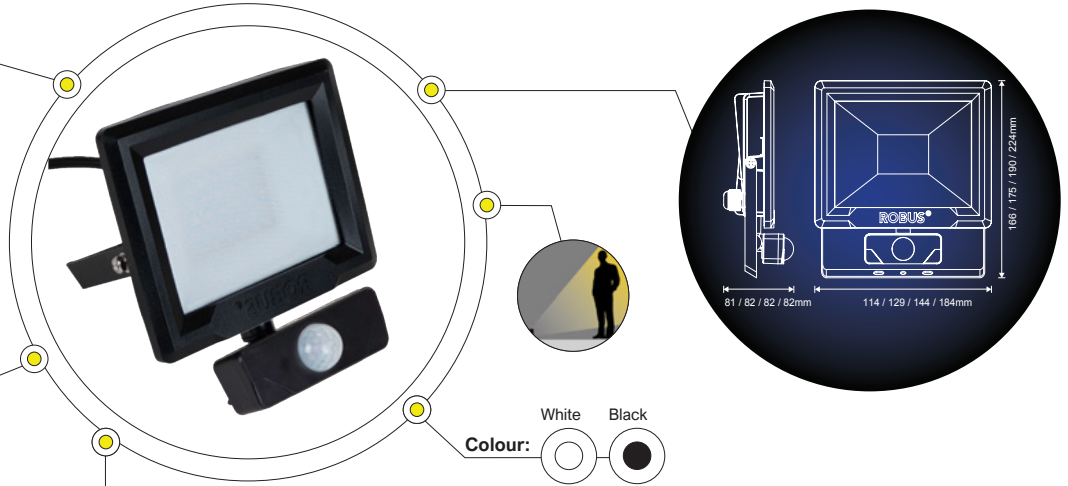

+ IP 65



LOA

2 YRS

ldt



PHYSICAL DATA

FEATURES

- Material: Powder-coated die-cast aluminium body and polycarbonate bezel and Tempered glass frosted diffuser, galvanised mounting bracket and stainless steel external fixings
- The HILUME with built-in PIR's offers optimal heat dissipation and high resistance to weather conditions
- Pre-wired with 1m of rubber flex and has pre-drilled angled mounting bracket with 180° adjustable angle and swivel of 150°
- Adjustable lux settings of 3lx to 2000lx and adjustable time delay of 10s to 10min

OPTIONS & ACCESSORIES

- HILUME with built-in PIR available for selection

MOUNTING

Surface

APPLICATION AREAS

Outdoor, Commercial, Residential, Retail, Hospitality

TECHNICAL DATA

RHL1030P/1040P-04

RHL2030P/2040P-04

RHL3030P/3040P-04

LAMP	LED	LED	LED
TOTAL POWER (W)	11.1 / 10.6W	20.4 / 19.7W	28.2 / 28W
SYSTEM OUTPUT (LM)	960 / 980LM	1640 / 1730LM	2110 / 2190LM
EFFICACY (LM/W)	87 / 93	87 / 88	75 / 78
CCT (K)	3000 / 4000K	3000 / 4000K	3000 / 4000K
CRI (RA)	80	80	80
BEAM ANGLE	100°	100°	100°
OPERATING VOLTAGE - VAC	220-240V	220-240V	220-240V
OPERATING TEMP (°C)	-20°C to 40°C	-20°C to 40°C	-20°C to 40°C
RATED LIFE (HRS)	20 000HRS	20 000HRS	20 000HRS
POWER FACTOR	0.6	0.6	0.99 / 0.9
ILLUM @ 1M (LUX)	420 / 430	720 / 760	920
WEIGHT (KG)	0.4KG	0.45KG	0.55KG
DIMENSIONS	L:114 x W:81 x H:166mm	L:129 x W:82 x H:175mm	L:144 x W:82 x H:190mm

- CD / KLM
- C0 - C180
 - C90 - C270

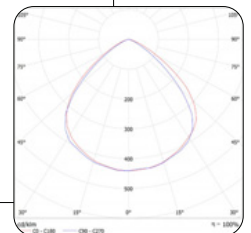

E&OE MAY OCCUR

REMY

FLOODLIGHTS

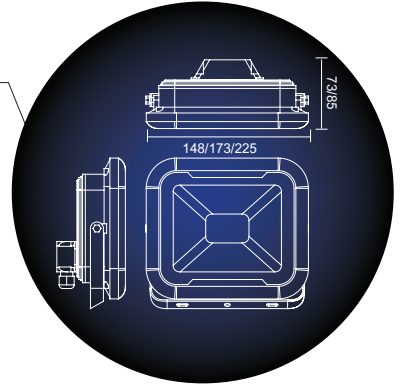
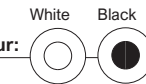

+ IP 65



LOA



ldt

PHYSICAL DATA

FEATURES

- LED replacement for 20-80W Metal Halide/ 75-350W Halogen flood lights
- Polycarbonate trim with tempered glass providing high impact rating of IK07
- Easy installation; Pre-drilled, angled mounting bracket for fast and simple installation
- No warm up or cool down period required by LED

OPTIONS & ACCESSORIES

- Available in three heights: 300, 600 and 900mm
- Signage arm and Spike mounting options available for selection

MOUNTING: Surface

APPLICATION AREAS

Outdoor, Commercial, Residential, Retail, Hospitality

TECHNICAL DATA

RRE10

RRE20

RRE30

RRE50

	RRE10	RRE20	RRE30	RRE50
LAMP	LED	LED	LED	LED
TOTAL POWER (W)	9.7W	19.7W	28.9W	46.6W
SYSTEM OUTPUT (LM)	800 / 880LM	1550 / 1730LM	2530 / 2750LM	4020 / 4670LM
EFFICACY (LM/W)	82 / 92	79 / 90	87 / 96	86 / 100
CCT (K)	3000 / 4000K	3000 / 4000K	3000 / 4000K	3000 / 4000K
CRI (RA)	80	80	80	80
BEAM ANGLE	100°	100°	100°	100°
OPERATING VOLTAGE-VAC	220-240V	220-240V	220-240V	220-240V
OPERATING TEMP (°C)	-20°C to +40°C	-20°C to +40°C	-20°C to +40°C	-20°C to +40°C
RATED LIFE (HRS)	30 000HRS	30 000HRS	30 000HRS	30 000HRS
POWER FACTOR	0.95	0.95	0.95	0.95
ILLUM @ 1M (LUX)	340 / 370	710 / 780	1110 / 1200	1660 / 1900
WEIGHT (KG)	0.49KG	0.63KG	0.83KG	1.1KG
DIMENSIONS	W:148 x D:73 x L:150mm	W:148 x D:73 x L:150mm	W:173 x D:85 x L:170mm	W:225 x D:85 x L:220mm

SIGNAGE ARM & SPIKE MOUNTING OPTIONS



- CD / KLM
- C0 - C180
 - C90 - C270

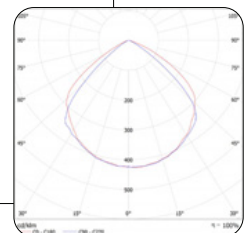

E&OE MAY OCCUR

LBLSL01

FLOODLIGHTS

OUTDOOR - FLOODLIGHTS - LBLSL01

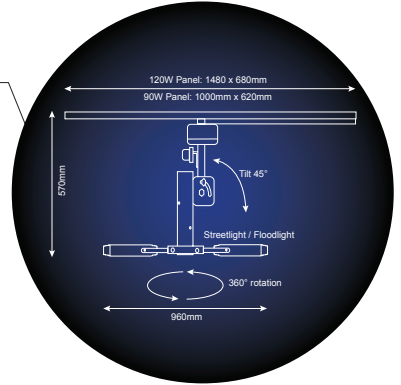

+ IP 65



2 YRS



PHYSICAL DATA

FEATURES

- Solar Panel: Polycrystalline 90W or 120W
- Battery Type: Lithium Ion Phosphate batteries, with overcharge control and under-voltage limit control
- Body Construction: Light fitting is LM6 aluminium powder-coated, pole bracket is hot-dipped galvanised steel
- Fits over 76mm pole
- 14W Streetlight / floodlight requires 90W PV Panel
- Double 14W Streetlight / floodlight requires 120W PV Panel
- 28W Streetlight / floodlight requires 120W PV Panel

OPTIONS & ACCESSORIES

- Higher CRI on request
- 3000K and 4000K on request

MOUNTING

Surface, Pole

APPLICATION AREAS

Outdoor, Commercial, Retail, Hospitality

TECHNICAL DATA

LBLSL01

LAMP	LED
TOTAL POWER (W)	14 / 28W (single light)
SYSTEM OUTPUT (LM)	1800 / 3600LM
CCT (K)	5000K
CRI (Ra)	80
OPERATING VOLTAGE-VAC	230V 50Hz
OPERATING TEMPE °C	-40°C to 88°C (solar panel)
ENVIRONMENTAL TEMP °C	-25°C to 48°C
WEIGHT (KG)	18KG / 22KG
PANEL DIMENSIONS	90W - 1000 x 680mm 120W - 1480 x 620mm
TOTAL DIMENSIONS	L:960 x H570mm

NOTE:

Due to low weight of light fittings – standard lighting poles may be used – please refer to our 6m pole as an example Allowances need to be made for windage

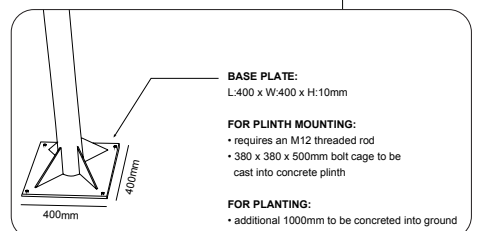
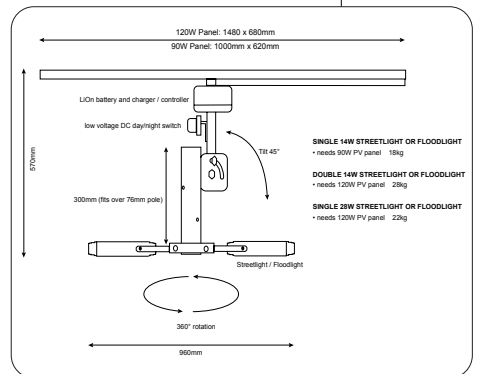

E&OE MAY OCCUR

LBLSL02

FLOODLIGHTS

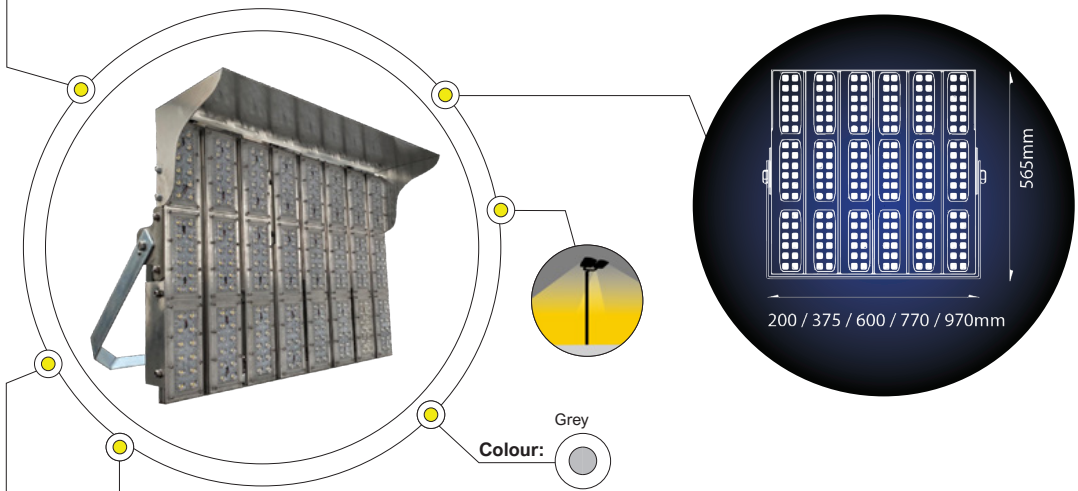

+ IP 67



3 YRS

ldt

PHYSICAL DATA

FEATURES

- Body constructed from extruded anodized aluminium with stainless steel brackets and powder coated aluminium junction box. Lenses – UV stable polycarbonate with silicone gaskets
- Rubber trailing cable used throughout
- 0-10V and Midnight Function dimming standard
- 20KV Surge protection across mains-in; then additional 6KV built into each power supply and Overheat protection

- Bolt-on anti-glare cowl available on request
- DALI, DMX and KNX dimming optional on request
- CRI 90 available on request (this will reduce lumen output by approx 8%)
- Beam angles available: Batwing, Asymmetrical, Symmetrical and Narrow

MOUNTING: Surface

OPTIONS & ACCESSORIES

- Magnetic scope for aiming available on request

APPLICATION AREAS

Outdoor, Commercial, Residential, Retail, Hospitality

TECHNICAL DATA

LBLSL02

LAMP	LED
TOTAL POWER (W)	300 / 600 / 900 / 1200 / 1500W
SYSTEM OUTPUT (LM)	43800 / 87600 / 131400 / 175200 / 219000LM
EFFICACY (LM/W)	146 - at full temperature
CCT (K)	3000 / 4000 / 5000 / 6500K
CRI (Ra)	80
OPERATING VOLTAGE-VAC	99-305VAC
OPERATING TEMPERATURE °C	-40°C TO 60°C
LUMEN MAINTENANCE	L80@60000HRS / L70@72000HRS
POWER FACTOR	>0.95
OUTPUT RIPPLE	<5%
WEIGHT (KG)	8 / 14 / 20 / 26 / 31KG
LENGTH	200 / 375 / 600 / 770 / 970mm
HEIGHT	565mm

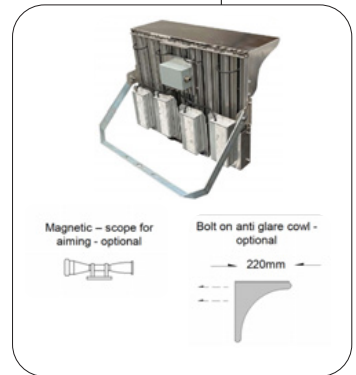

- CD / KLM
- C0 - C180
 - C90 - C270

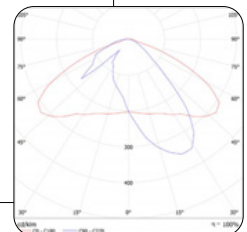

E&OE MAY OCCUR

> GARDEN SPIKES & SPOTS

COMMERCIAL & ARCHITECTURAL



CRU

GARDEN SPOT / SPIKE

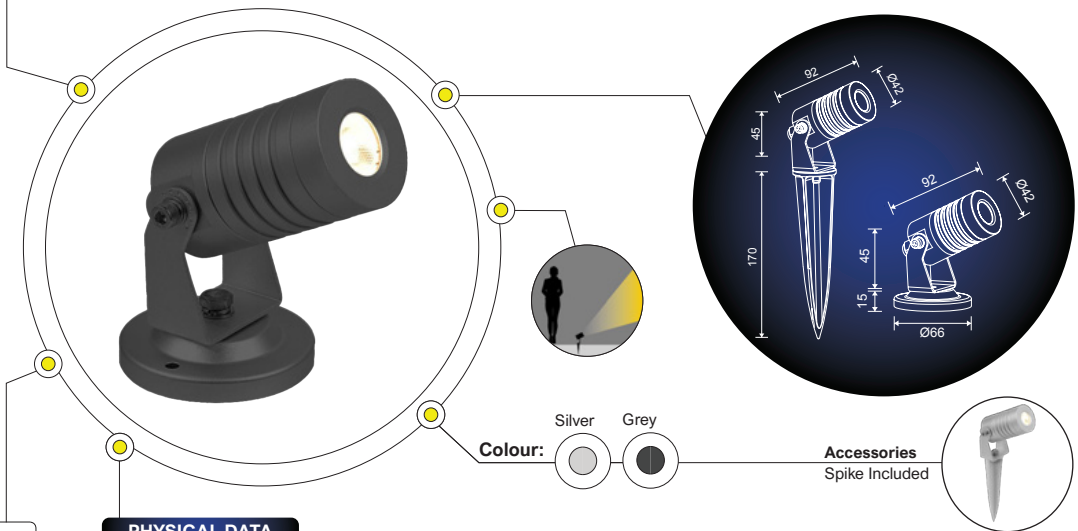

+ IP 65



LOA

3 YRS

ldt



PHYSICAL DATA

FEATURES

- Material: Aluminium
- The CRU is a compact mini 3W spot that has a sandblasted anodized treatment making it weatherproof, making it the perfect choice for illuminating your landscape
- Free adjustment of projecting angle

OPTIONS & ACCESSORIES

- Spike and base-plate included

- The CRU DC 24V option is available for selection
- The CRU RGB option is available for selection
- The CRU H Single and Double Pole versions are available for selection

MOUNTING: Surface, Spike

APPLICATION AREAS: Outdoor, Commercial, Residential, Retail, Hospitality

TECHNICAL DATA

LF701011A

LAMP	LED
TOTAL POWER (W)	1.8W
SYSTEM OUTPUT (LM)	127LM
CCT (K)	2700 / 3000 / 4000K
CRI (RA)	80
BEAM ANGLE	12° / 30°
OPERATING VOLTAGE-VAC	100-240V
SOURCE POWER (W)	2.6W
SOURCE OUTPUT (LM)	177LM
WEIGHT (KG)	0.36KG
LAMP DIMENSIONS	D:φ24 x L:92 x H:45mm
SPIKE DIMENSIONS	D:φ66 x H:170mm



- CD / KLM
- C0 - C180
 - C90 - C270

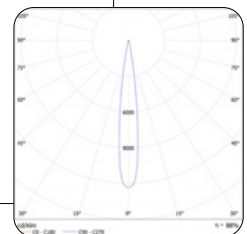

E&OE MAY OCCUR

GADDIS M

GARDEN SPOT / SPIKE

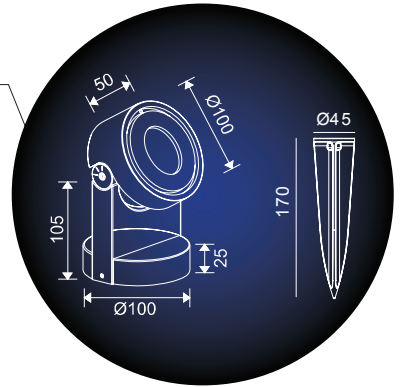

Dark Grey

Colour:



Accessories

Spike & Hood Included

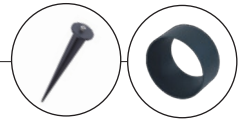

PHYSICAL DATA

FEATURES

- Material: Aluminium
- The GADDIS M is a wonderfully flexible and elegant choice for the outdoor illumination of trees, sculptures and facades
- The GADDIS is a projection lamp with a compact shape and it allows a 90° tilt

selection

- The GADDIS M+ is a 24VDC option available for selection
- The GADDIS H M bollard is available with a 600mm height

MOUNTING

Surface, Spike

OPTIONS & ACCESSORIES

- Anti-glare extension hood/cover and spike included
- The GADDIS M is available as a 7W or 15W option for

APPLICATION AREAS

Outdoor, Commercial, Residential, Retail, Hospitality

+ IP 65



LOA

3 YRS

ldt



TECHNICAL DATA

LF727815

LF727715

LF725715E

LF727515E

	LF727815	LF727715	LF725715E	LF727515E
LAMP	LED	LED	LED	LED
TOTAL POWER (W)	6W	6W	13.5W	14.5W
SYSTEM OUTPUT (LM)	479LM	479LM	997LM	997LM
CCT (K)	2700 / 3000 / 4000K	2700 / 3000 / 4000K	2700 / 3000 / 4000K	2700 / 3000 / 4000K
CRI (RA)	80	80	90	90
BEAM ANGLE	15° / 30°	15° / 18° / 30°	18° / 30°	15° / 18° / 30°
OPERATING VOLTAGE-VAC	100-240V	24V DC	220-240V	24V DC
SOURCE POWER (W)	6W	7.3W	15.6W	15.6W
SOURCE OUTPUT (LM)	660LM	660LM	1386LM	1386LM
CURRENT (MA)	500MA	n/a	900MA	n/a
FLICKER FACTOR	789.47HZ / 3.71%	n/a	100HZ / 1.63%	n/a
WEIGHT (KG)	1.64KG	1.62KG	1.65KG	1.62KG
DIMENSIONS	D:φ100 x H:105mm	D:φ100 x H:105mm	D:φ100 x H:105mm	D:φ100 x H:105mm

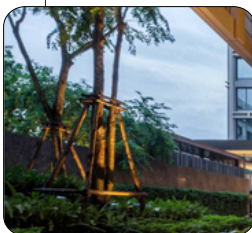

- CD / KLM
- C0 - C180
 - C90 - C270

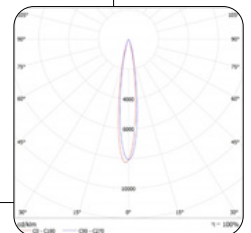

E&OE MAY OCCUR

PICTOR SS

GARDEN SPOT / SPIKE

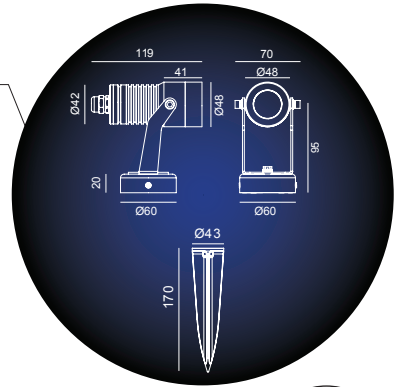

Dark Grey

Colour:



Accessories

Spike Included



+ IP 65



LOA

3 YRS

ldt



PHYSICAL DATA

FEATURES

- Material : Aluminium
- Flexibility and elegance describe the PICTOR perfectly. It's adjustable head allows for the perfect key illumination of your landscape
- Spike and base-plate included for flexible installation options
- Adjustable head makes for easy positioning of light beam

- The PICTOR SS DC 24V option is also available for selection (D:48 x L:105mm)
- The PICTOR is available in the following diameter options for selection: 48mm, 62mm, 75mm and 102mm

MOUNTING: Surface, In-Ground

APPLICATION AREAS

Outdoor, Commercial, Residential, Retail, Hospitality

OPTIONS & ACCESSORIES

TECHNICAL DATA

LF733116A

LAMP	LED
TOTAL POWER (W)	3W / 4W
SYSTEM OUTPUT (LM)	312LM
CCT (K)	2700 / 3000 / 4000K
CRI (RA)	80
BEAM ANGLE	18° / 26° / 28°

OPERATING VOLTAGE-VAC	100-240V
SOURCE POWER (W)	3.4W / 4.2W
CURRENT (MA)	500MA
FLICKER FACTOR	110HZ / 0.47%
DIMENSIONS	D:φ48 x L:119mm
MOUNTING PLATE	D:φ60 x L:20mm
SPIKE DIMENSIONS	D:φ43 x L:170mm



- CD / KLM
- C0 - C180
 - C90 - C270

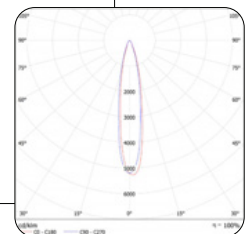

E&OE MAY OCCUR

PICTOR L

GARDEN SPOT / SPIKE

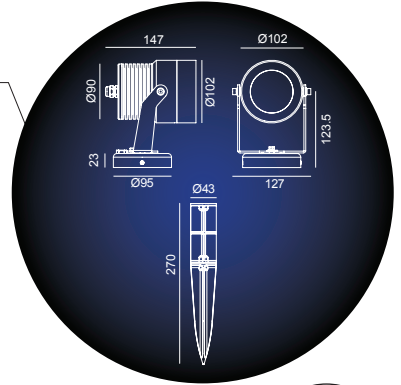

Colour:



Accessories
Spike Included



+ IP
65



LOA

3 YRS



PHYSICAL DATA

FEATURES

- Material : Aluminium
- Flexibility and elegance describe the PICTOR perfectly. It's adjustable head allows for the perfect key illumination of your landscape
- Adjustable head makes for easy positioning of light beam

- The PICTOR L DC 23.54W is available for selection
- The PICTOR is available in the following diameter options for selection: 48mm, 62mm, 75mm and 102mm

MOUNTING

Surface, Spike

APPLICATION AREAS

Outdoor, Commercial, Residential, Retail, Hospitality

OPTIONS & ACCESSORIES

- Spike and base-plate included

TECHNICAL DATA

LF732715EA

LAMP	LED
TOTAL POWER (W)	21.6W
SYSTEM OUTPUT (LM)	1870LM
CCT (K)	2700 / 3000 / 4000K
CRI (RA)	90
BEAM ANGLE	36°

OPERATING VOLTAGE-VAC	100-240V
SOURCE POWER (W)	26W
SYSTEM OUTPUT (LM)	2191LM
DIMENSIONS	D:φ102 x L:147

Please note: Minimum Order Quantities apply

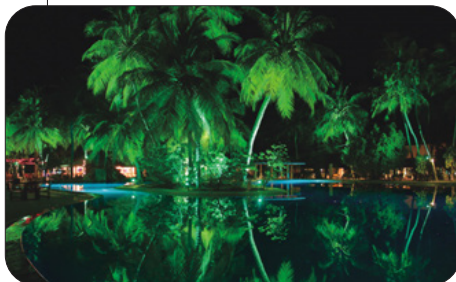

E&OE MAY OCCUR

SPARROW

GARDEN SPOT

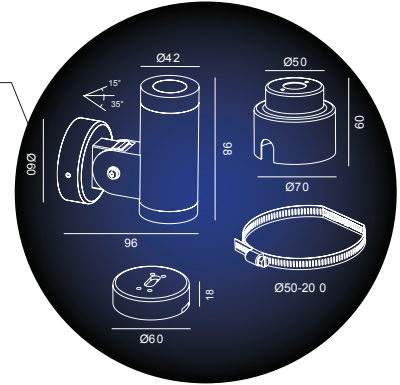

+ IP 65



LOA

3 YRS

ldt



PHYSICAL DATA

FEATURES

- Material : Aluminium
- The SPARROW is a tiny spotlight that is ideal for landscape illumination
- Adjustable - upward tilt of 15° and downward tilt of 35°

MOUNTING

Surface

APPLICATION AREAS

Outdoor, Commercial, Residential, Retail, Hospitality

TECHNICAL DATA

LF432317A

LAMP	LED
TOTAL POWER (W)	3W
SYSTEM OUTPUT (LM)	168LM
CCT (K)	2700 / 3000 / 4000K
CRI (Ra)	80
BEAM ANGLE	25°
OPERATING VOLTAGE-VAC	100-240V
SOURCE POWER (W)	4W
SOURCE OUTPUT (LM)	179LM
CURRENT (MA)	700MA
FLICKER FACTOR	41.15HZ / 0.57%
DIMENSIONS	D:φ42 x H:96 x W:96mm
MOUNTING CUP	D:φ60mm

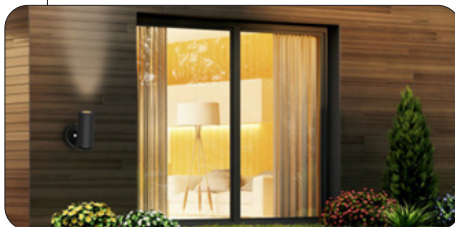

- CD / KLM
- C0 - C180
 - C90 - C270

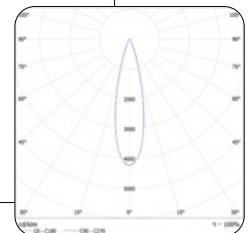

E&OE MAY OCCUR

LLEDS02-3

GU10 GARDEN SPOT

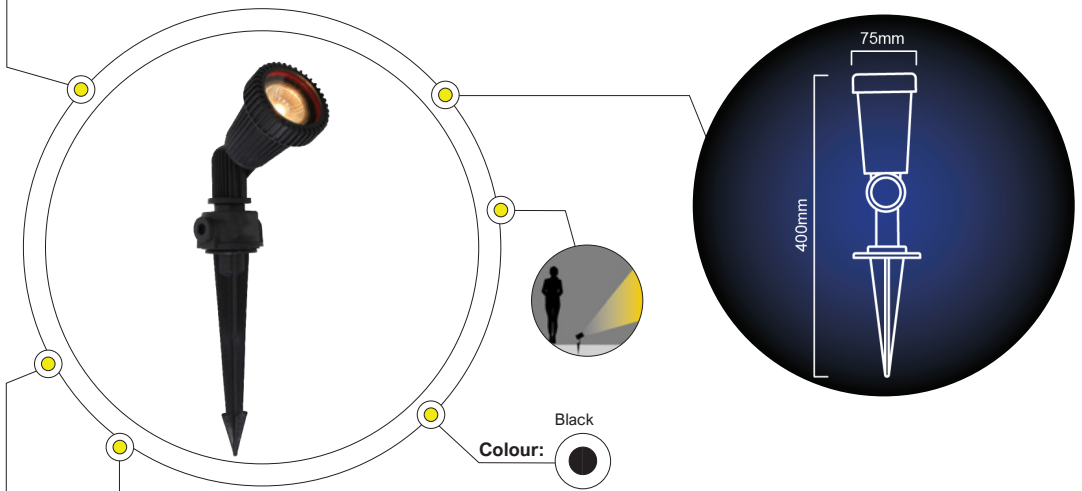

+ IP 54



1 YR

PHYSICAL DATA

FEATURES

- Material: polycarbonate with clear tempered glass lens
- Includes spike
- Adjustable

MOUNTING

Surface, In-Ground

APPLICATION AREAS

Outdoor, Commercial, Residential, Retail, Hospitality

PLEASE NOTE

- LLEDS03 - Does not include transformer CO79 and CO76
- Lamp specifications and lamp warranties may differ

TECHNICAL DATA

	LLEDS02	LLEDS03
LAMP HOLDER	GU10	GU5.3
VOLTAGE	max 35W PAR16 220-240V (50/60Hz)	max 35W MR16 12V 220-240V (50/60Hz)
DIAMETER	D:φ75 x H:400mm	D:φ75 x H:400mm

LPPAR165036



TECHNICAL DATA

	LPPAR165036	G947WW
LAMP	LED	MR16
DIMMABLE	YES	NO
BASE	GU10	GU5.3
TOTAL POWER (W)	5.5W	7W
TOTAL OUTPUT (LM)	380 / 400LM	525LM
CCT (K)	3000 / 4000 / 6500K	3000K
CRI (RA)	90	80
RATED LIFE (HRS)	25 000HRS	25 000HRS
OPERATING VOLTAGE	220-240V	220-240V
OPERATING TEMP °C	-20°C to +40°C	-20°C to +40°C
DIMENSIONS	D:φ51 x H:52mm	D:φ50 x L:53.5mm

G947W



E&OE MAY OCCUR

> BURIED UPLIGHTS

COMMERCIAL & ARCHITECTURAL



GT FROST DC

LED UPLIGHTS

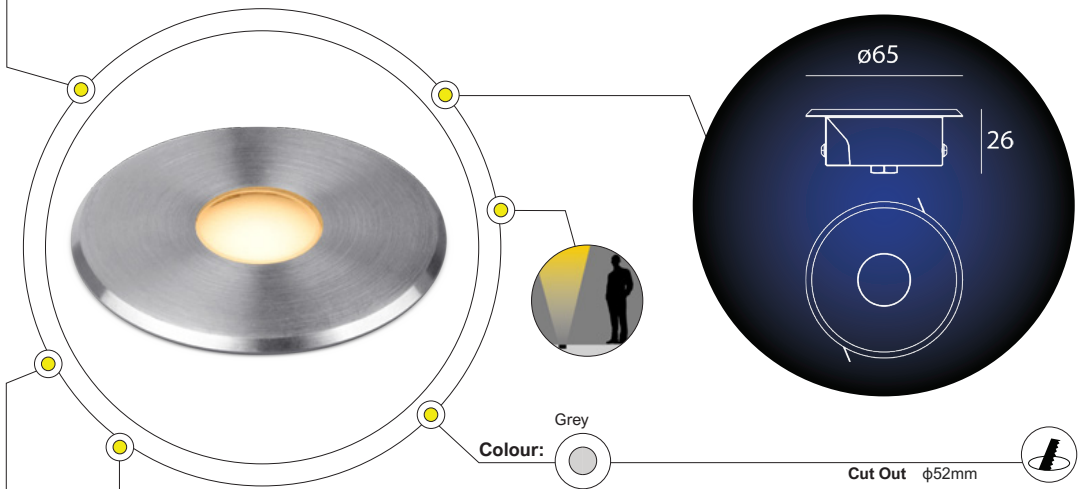

PHYSICAL DATA

FEATURES

- Material: Aluminium and Stainless Steel 316
- The GT FROST DC is a miniature in-ground fitting and is a great example of functionality and style
- The GT FROST DC, with its slim body, can be installed in areas with limited space available, making it extremely versatile

- The GT DC is available in 3 different options for selection: standard, asymmetric and frosted

MOUNTING

Recessed

APPLICATION AREAS

Indoor, Commercial, Residential, Retail, Hospitality

OPTIONS & ACCESSORIES

+ IP
67



LOA

✓
3 YRS

TECHNICAL DATA

LF658111

LAMP	LED
TOTAL POWER (W)	2.5W
SYSTEM OUTPUT (LM)	19LM
CCT (K)	2700 / 3000 / 4000K
CRI (Ra)	80
BEAM ANGLE	180°
OPERATING VOLTAGE-VAC	3V DC
CURRENT (MA)	700MA
DIMENSIONS	D:φ65 x H:26mm
CUT OUT	D:φ52mm

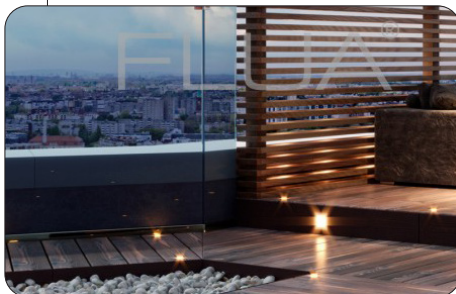

E&OE MAY OCCUR

LGL05

MICRO LED UPLIGHTS

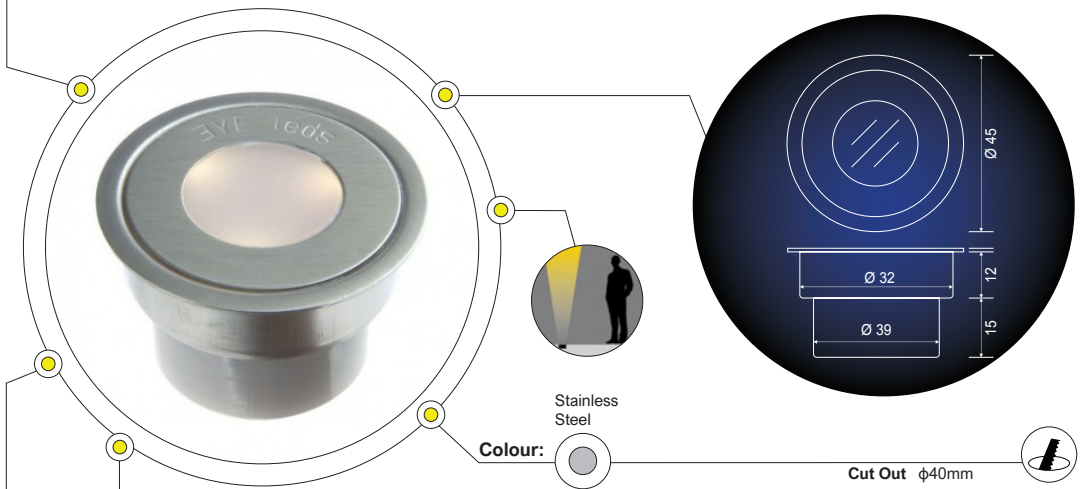

+ IP 67



3 YRS

PHYSICAL DATA

FEATURES

- Material: Marine grade stainless steel (316) in a brushed finish
- Remains cool to the touch
- Low profile installs flush
- Corrosion and UV resistant
- Engineered to withstand heavy use

OPTIONS & ACCESSORIES

- Available in cool white, warm white, blue and amber

MOUNTING: Recessed

APPLICATION AREAS

Outdoor, Indoor, Commercial, Residential, Retail, Hospitality

TECHNICAL DATA

LGL05

LAMP	LED
TOTAL POWER (W)	0.3W / 25mA
SYSTEM OUTPUT (LM)	1.6LM
CCT (K)	2700K / 5500K
OPERATING VOLTAGE-VAC	12V DC
OPERATING TEMP(°C)	-35°C to +65°C
DRIVE / WALKOVER PRESSURE	MAX 2850N / 285KG
RATED LIFE (HRS)	100 000 HRS

NOTE: Driver supplied separately



E&OE MAY OCCUR

MAX S

LED UPLIGHTS

OUTDOOR - BURIED UPLIGHTS - MAX S

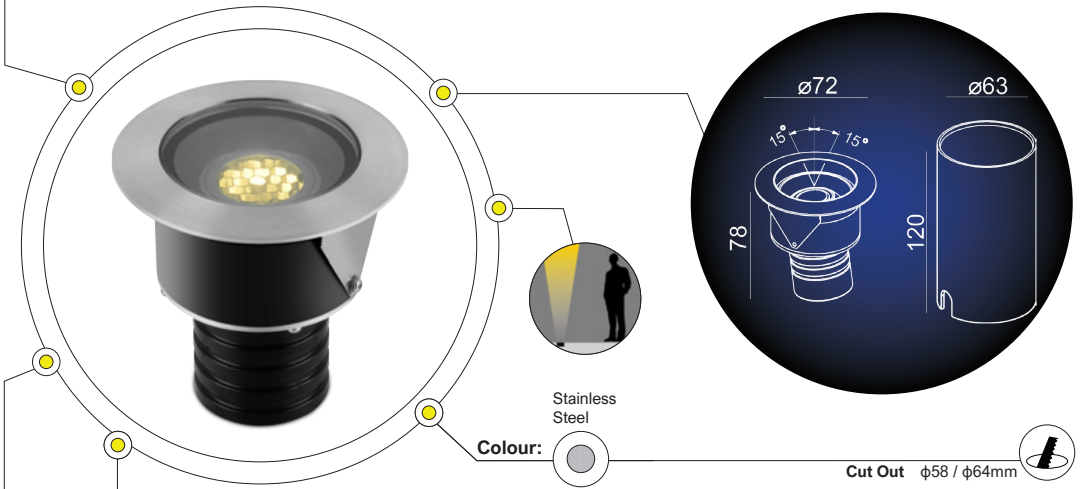

+ IP 67



LOA

3 YRS

ldt

PHYSICAL DATA

FEATURES

- Material: Stainless steel
- The Max is the best example of beauty and functionality and enhances the architectural character of any project
- Adjustable by adjusting the internal head

OPTIONS & ACCESSORIES

- The MAX S DC 24V option is available for selection

- Anti-glare cellular network available
- The MAX S, 7W Stainless steel lamp for 24V application with high temperature protection for harsh environments available

MOUNTING: In-Ground, Recessed

APPLICATION AREAS

Outdoor, Commercial, Residential, Retail, Hospitality

TECHNICAL DATA

LF656617

LAMP	LED
TOTAL POWER (W)	1.8W
SYSTEM OUTPUT (LM)	119LM
CCT (K)	2700 / 3000 / 4000K
CRI (Ra)	80
BEAM ANGLE	15° / 30°

OPERATING VOLTAGE-VAC	100-240V
SOURCE POWER (W)	2.6W
SOURCE OUTPUT (LM)	177LM
WEIGHT (KG)	0.43KG
LAMP DIMENSIONS	D:φ72 x H:78mm
HOUSING DIMENSIONS	D:φ63 x H:120mm
CUT OUT	D:φ58 / 64mm



- CD / KLM
- C0 - C180
- C90 - C270

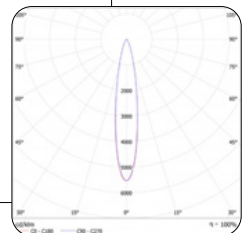

E&OE MAY OCCUR

MAX M

LED UPLIGHTS

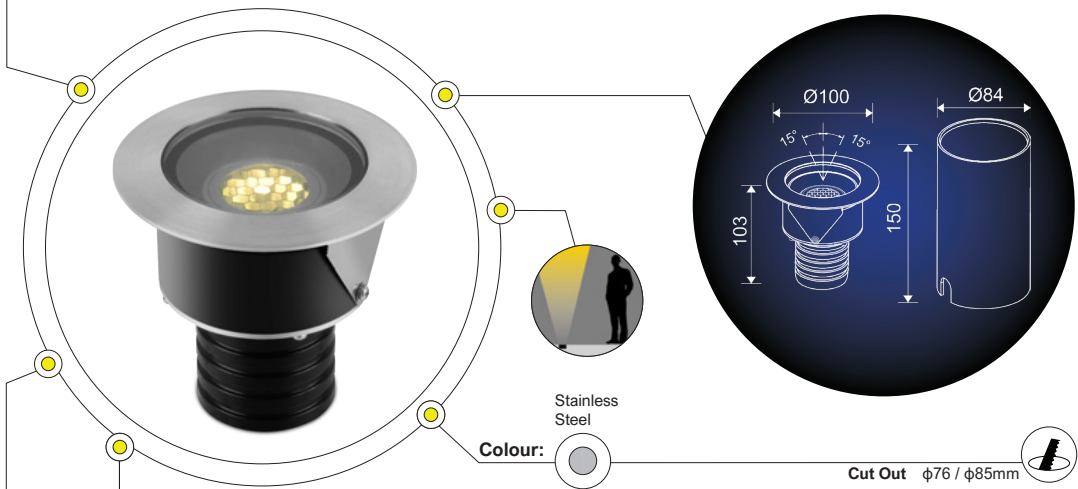

+ IP 67



LOA

3 YRS

ldt

PHYSICAL DATA

FEATURES

- Material: Stainless Steel
- The MAX is the best example of beauty and functionality and enhances the architectural character of any project
- Adjustable by adjusting the internal head

OPTIONS & ACCESSORIES

- The smaller MAX S, φ72mm diameter; is available for

selection

- Anti-glare cellular network available

MOUNTING

In-Ground, Recessed

APPLICATION AREAS

Outdoor, Commercial, Residential, Retail, Hospitality

TECHNICAL DATA

LF605815E

LAMP	LED
TOTAL POWER (W)	6.3W
SYSTEM OUTPUT (LM)	332LM
CCT (K)	2700 / 3000 / 4000K
CRI (Ra)	90
BEAM ANGLE	15° / 24° / 38°

OPERATING VOLTAGE-VAC	100-240V
SOURCE POWER (W)	7W
WEIGHT (KG)	0.83KG
LAMP DIMENSIONS	D:φ100 x H:103mm
HOUSING DIMENSIONS	D:φ84 x H:150mm
CUT OUT	D:φ76 / 85mm



- CD / KLM
- C0 - C180
- C90 - C270
- BEAM ANGLE

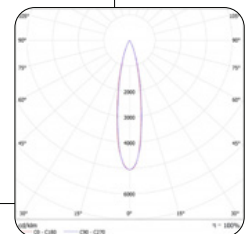

E&OE MAY OCCUR

SURROUND R1

LED UPLIGHTS

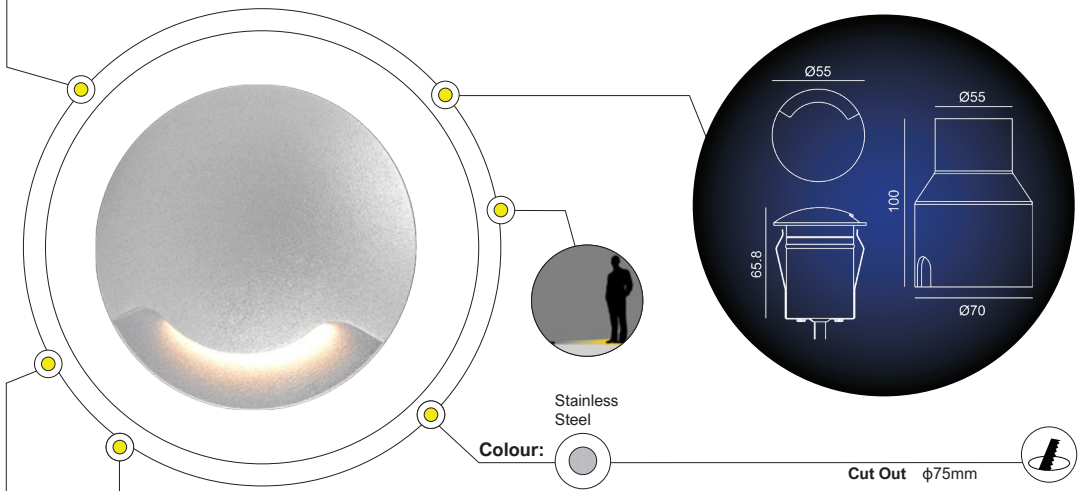

PHYSICAL DATA

+ IP 67



LOA

3 YRS

FEATURES

- Material: Stainless Steel 316
- The SURROUND is a collection of in-ground luminaires that offer both guidance and decorative lighting
- The SURROUND creates unique lighting patterns on the ground

- light beam options for selection
- A 24VDC option is available for selection

MOUNTING

Recessed

APPLICATION AREAS

Outdoor, Commercial, Residential, Retail, Hospitality

OPTIONS & ACCESSORIES

- The SURROUND is available with one, two or three

TECHNICAL DATA

LF667317A

LAMP	LED
TOTAL POWER (W)	1.8W
SYSTEM OUTPUT (LM)	24LM
CCT (K)	2700 / 3000 / 4000K
CRI (Ra)	80
BEAM ANGLE	RADIAL

OPERATING VOLTAGE-VAC	100-240V
SOURCE POWER (W)	2W
SOURCE OUTPUT (LM)	175LM
CURRENT (MA)	600MA
DIMENSIONS	D:φ55 x H:65.8mm
CUT OUT	D:φ75mm

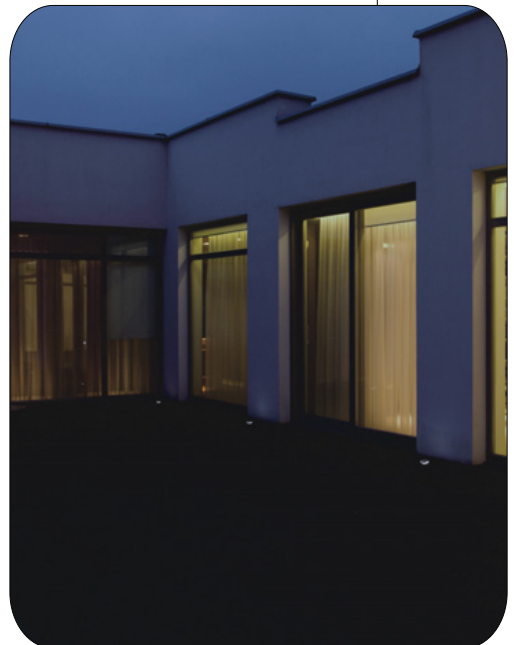
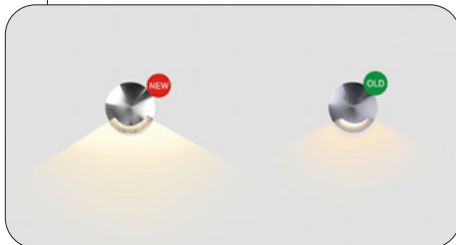

VELA XL

LED UPLIGHTS

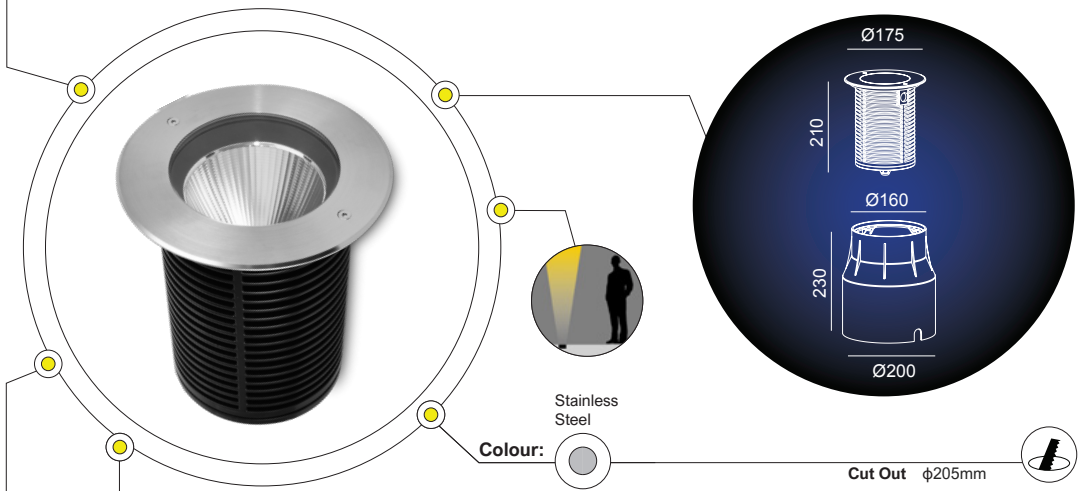

+ IP 67



LOA

3 YRS

ldt



PHYSICAL DATA

FEATURES

- Material: Aluminium
- The VELA is an extensive and efficient series of in-ground luminaires. Water and shock resistant, this uplight serves to enhance the architectural character of any project and landscape

OPTIONS & ACCESSORIES

- The VELA range offers various power options from 2.4W up to 23.9W within the range

- Range offers sizes from Super Small to Extra Large
- Round and square outer frames available
- Adjustable function options available
- Asymmetric lens, RGB, RGBW and 24V DC options available in the range

MOUNTING: In-Ground, Recessed

APPLICATION AREAS

Outdoor, Commercial, Residential, Retail, Hospitality

TECHNICAL DATA

LF656617

LAMP	LED
TOTAL POWER (W)	21.6W
SYSTEM OUTPUT (LM)	2188LM
CCT (K)	2700 / 3000 / 4000K
CRI (Ra)	90
BEAM ANGLE	15° / 24° / 38°

OPERATING VOLTAGE-VAC	100-240V
SOURCE POWER (W)	23.9W
SOURCE OUTPUT (LM)	3055LM
FLICKER FACTOR	100HZ / 28.43%
WEIGHT (KG)	3.78KG
LAMP DIMENSIONS	D:φ175 x H:210mm
HOUSING DIMENSIONS	D:φ200 x H:230mm
CUT OUT	D:φ205mm

Please note: Minimum Order Quantities apply

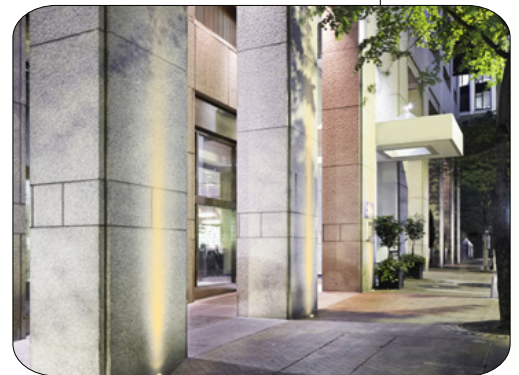

- CD / KLM
- C0 - C180
 - C90 - C270

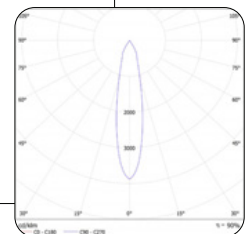

E&OE MAY OCCUR

VELA ML SQUARED DC

LED UPLIGHTS

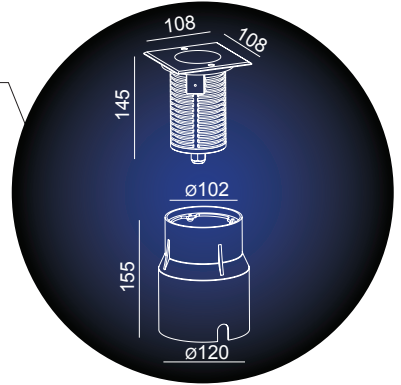
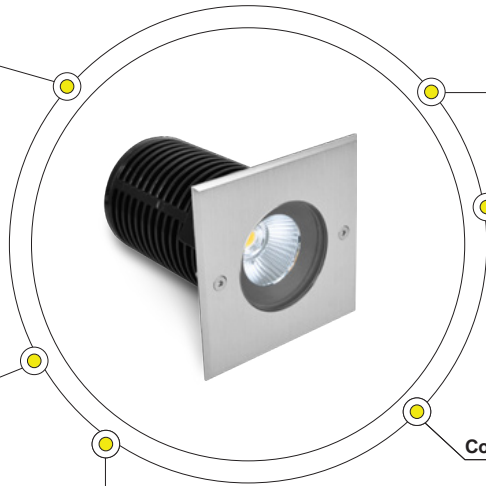

Stainless Steel

Colour:



Cut Out ϕ 125mm



PHYSICAL DATA

FEATURES

- Material: Stainless Steel
- The VELA is an extensive and efficient series of in-ground luminaires. Water and shock resistant, this uplight serves to enhance the architectural character of any project and landscape

- Range offers sizes from Super Small to Extra Large
- Round and square outer frames available
- Adjustable function options available
- Asymmetric lens, RGB, RGBW and 24V DC options available in the range

OPTIONS & ACCESSORIES

- The VELA range offers various power options from 2.4W up to 23.9W within the range

MOUNTING: In-Ground, Recessed

APPLICATION AREAS

Outdoor, Commercial, Residential, Retail, Hospitality

+ IP 67



LOA

3 YRS

ldt



TECHNICAL DATA

LF631712EB

LAMP	LED
TOTAL POWER (W)	10W
SYSTEM OUTPUT (LM)	734LM
CCT (K)	2700 / 3000 / 4000K
CRI (Ra)	90
BEAM ANGLE	18° / 25° / 38°
OPERATING VOLTAGE-VAC	24VDC
SOURCE OUTPUT (LM)	1212LM
LAMP DIMENSIONS	L:108 x W:108 x H:145mm
HOUSING DIMENSIONS	D: ϕ 102 x H:155mm
CUT OUT	D: ϕ 125mm

Please note: Minimum Order Quantities apply

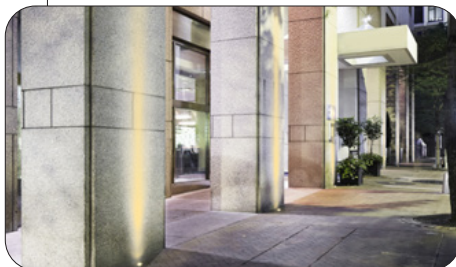
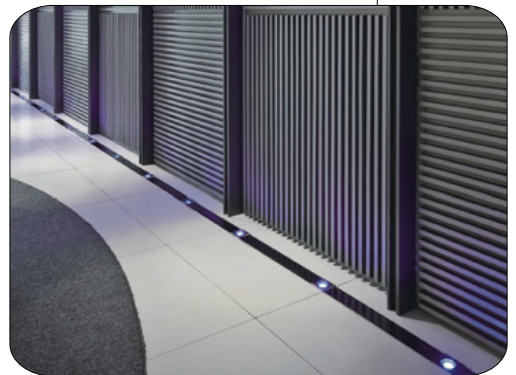

CD / KLM

● C0 - C180

● C90 - C270

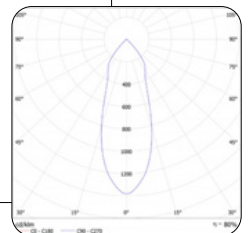

E&OE MAY OCCUR

> WALL WASHERS

COMMERCIAL & ARCHITECTURAL



Project: Medo Clinic, Stellenbosch / Photography: Ilenko Kijhn

OCEAN

WALL WASHERS

OUTDOOR - WALL WASHERS - OCEAN

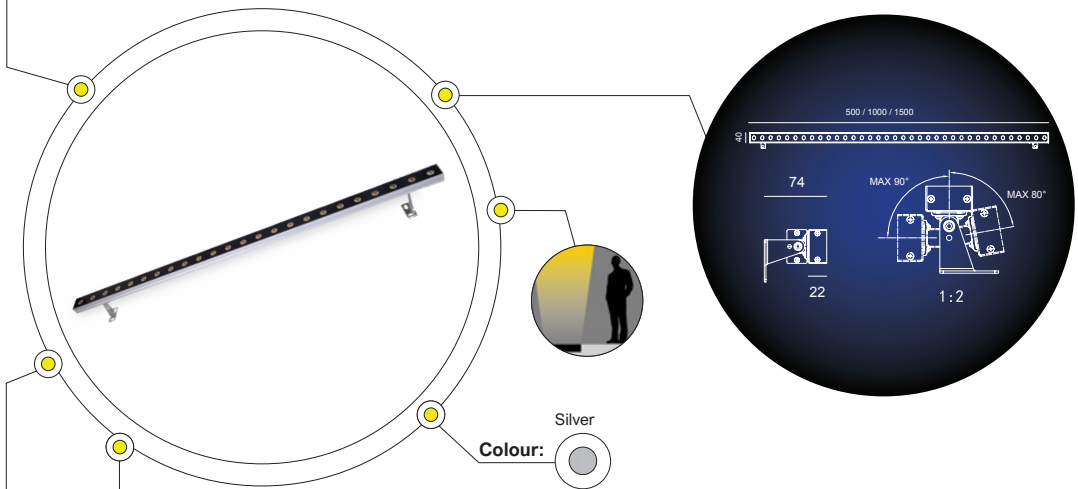

+ IP 65



LOA

3 YRS

ldt



PHYSICAL DATA

FEATURES

- Material: Aluminium
- The OCEAN linear series is a modern and highly efficient solution for architectural and decorative lighting
- The fixture provides uniform indirect lighting and is available in three lengths; 500mm, 1000mm and 1500mm

OPTIONS & ACCESSORIES

- The OCEAN is available as a 24Vdc option for selection

MOUNTING

Surface

APPLICATION AREAS

Outdoor, Commercial, Residential, Retail, Hospitality

TECHNICAL DATA

LF817116A

LF817316A

LF817516A

LAMP	LED	LED	LED
TOTAL POWER (W)	10.8W	21.6W	30.4W
SYSTEM OUTPUT (LM)	880LM	1419LM	1714LM
CCT (K)	2700 / 3000 / 4000K	2700 / 3000 / 4000K	2700 / 3000 / 4000K
CRI (Ra)	90	90	90
BEAM ANGLE	22°	22°	22°
OPERATING VOLTAGE-VAC	100-240V	100-240V	100-240V
FLICKER FACTOR	110HZ / 0.6%	102.04HZ / 1.35%	102.04HZ / 1.35%
DIMENSIONS	L:500 x W:40 x H:74mm	L:1000 x W:40 x H:74mm	L:1500 x W:40 x H:74mm



CD / KLM

● C0 - C180

● C90 - C270

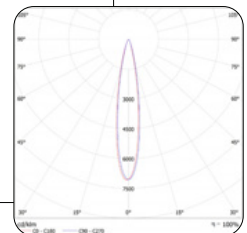

E&OE MAY OCCUR

RIBBON S RGB v2.0

WALL WASHERS

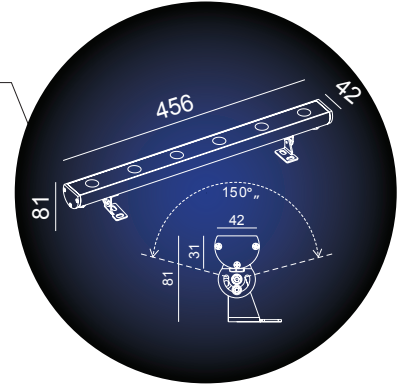
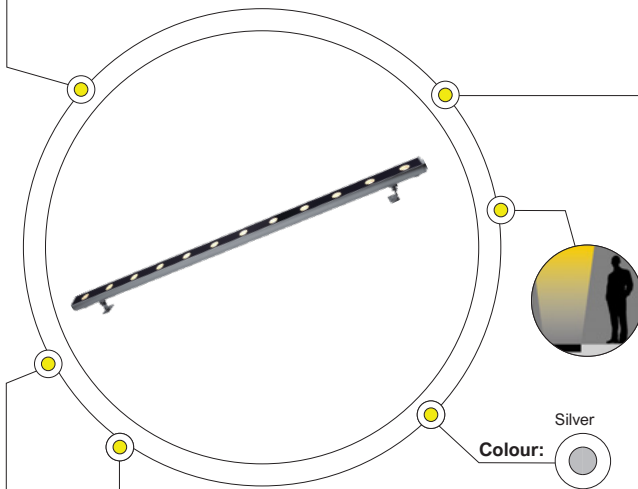

+ IP 65



LOA

3 YRS



PHYSICAL DATA

FEATURES

- Material: Aluminium
- The RIBBON is an extra slim series of compact low-voltage wall-washers, ideal for facade illumination
- Stainless Steel Bracket
- Low Flicker, Convenient Installation, Adjustable Angle
- Requires Driver

- Lengths available: 456mm, 912mm and 1368mm
- Available as 3IN1 and variable temperature colour optional
- Optional asymmetrical and oval beam lenses available

MOUNTING: Surface, requires driver

APPLICATION AREAS

Outdoor, Commercial, Residential, Hospitality, Retail

OPTIONS & ACCESSORIES

TECHNICAL DATA

LF816814

LAMP	COB
TOTAL POWER (W)	16.3W
CCT (K)	RGB 3IN1
CRI (Ra)	90
BEAM ANGLE	30°
OPERATING VOLTAGE-VAC	24VDC
WEIGHT (KG)	2KG
DIMENSIONS	L:456 x W:42 x H:59mm

DRIVER DATA

LBL35WP24V

MATERIAL	ALUMINIUM
TYPE	LED DRIVER
OUTPUT POWER	36W
INPUT VOLTAGE OUTPUT	90-370V
VOLTAGE	24V DC
AMPERE (A)	1.5A
DIMENSIONS	L:148 x B:40 x H:30mm
APPLICATION	PER UNIT

DRIVER DATA

LBL150WP24V

MATERIAL	ALUMINIUM
TYPE	LED DRIVER
OUTPUT POWER	151.2W
INPUT VOLTAGE OUTPUT	180-305V
VOLTAGE	24V
AMPERE (A)	6.3A
DIMENSIONS	L:191 x B:63 x H:37.5mm
APPLICATION	4 UNITS TOGETHER



E&OE MAY OCCUR

RIBBON M RGB v2.0

WALL WASHERS

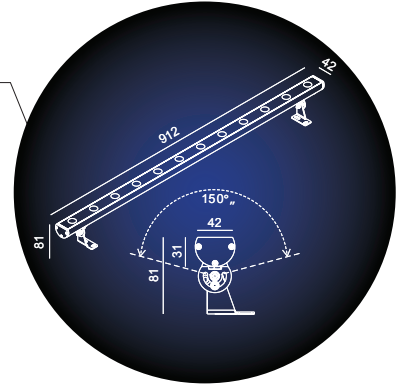
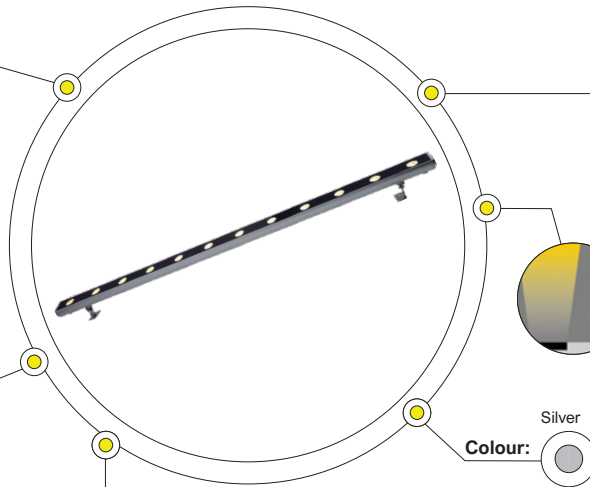

PHYSICAL DATA

FEATURES

- Material: Aluminium
- The RIBBON is an extra slim series of compact low-voltage wall-washers, ideal for facade illumination
- Stainless Steel Bracket
- Low Flicker, Convenient Installation, Adjustable Angle
- Requires Driver

- Lengths available: 456mm, 912mm and 1368mm
- Available as 3IN1 and variable temperature colour optional
- Optional asymmetrical and oval beam lenses available

MOUNTING: Surface, requires driver

APPLICATION AREAS

Outdoor, Commercial, Residential, Hospitality, Retail

OPTIONS & ACCESSORIES

+ IP 65



LOA

3 YRS



TECHNICAL DATA

LF816914

LAMP	COB
TOTAL POWER (W)	33.1W
CCT (K)	RGB 3IN1
CRI (Ra)	90
BEAM ANGLE	30°
OPERATING VOLTAGE-VAC	24VDC
WEIGHT (KG)	2KG
DIMENSIONS	L:912 x W:42 x H:59mm

DRIVER DATA

LBL35WP24V

MATERIAL	ALUMINIUM
TYPE	LED DRIVER
OUTPUT POWER	36W
INPUT VOLTAGE OUTPUT	90-370V
VOLTAGE	24V DC
AMPERE (A)	1.5A
DIMENSIONS	L:148 x B:40 x H:30mm
APPLICATION	PER UNIT



DRIVER DATA

LBL150WP24V

MATERIAL	ALUMINIUM
TYPE	LED DRIVER
OUTPUT POWER	151.2W
INPUT VOLTAGE OUTPUT	180-305V
VOLTAGE	24V
AMPERE (A)	6.3A
DIMENSIONS	L:191 x B:63 x H:37.5mm
APPLICATION	4 UNITS TOGETHER

E&OE MAY OCCUR

RIBBON L RGB v2.0

WALL WASHERS

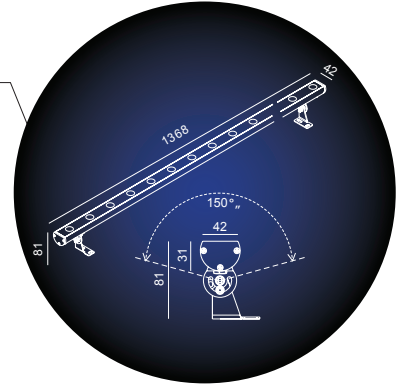
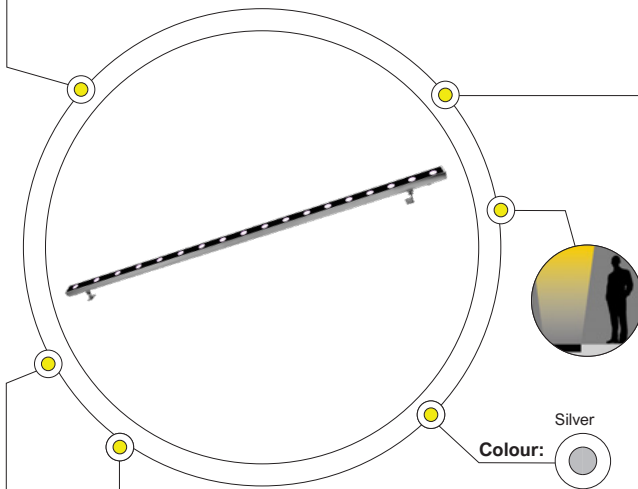

+ IP 65



LOA

3 YRS

ldt



PHYSICAL DATA

FEATURES

- Material: Aluminium
- The RIBBON is an extra slim series of compact low-voltage wall-washers, ideal for facade illumination
- Stainless Steel Bracket
- Low Flicker, Convenient Installation, Adjustable Angle
- Requires Driver

- Lengths available: 456mm, 912mm and 1368mm
- Available as 3IN1 and variable temperature colour optional
- Optional asymmetrical and oval beam lenses available

MOUNTING: Surface, requires driver

APPLICATION AREAS

Outdoor, Commercial, Residential, Hospitality, Retail

OPTIONS & ACCESSORIES

TECHNICAL DATA

LF817014

LAMP	COB
TOTAL POWER (W)	51W
CCT (K)	RGB 3IN1
CRI (Ra)	90
BEAM ANGLE	30°
OPERATING VOLTAGE-VAC	24VDC
DIMENSIONS	L:1368 x W:42 x H:59mm

DRIVER DATA

LBL35WP24V

MATERIAL	ALUMINIUM
TYPE	LED DRIVER
OUTPUT POWER	36W
INPUT VOLTAGE OUTPUT	90-370V
VOLTAGE	24V DC
AMPERE (A)	1.5A
DIMENSIONS	L:148 x B:40 x H:30mm
APPLICATION	PER UNIT

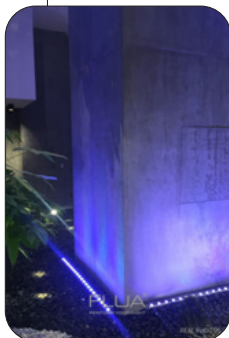

DRIVER DATA

LBL150WP24V

MATERIAL	ALUMINIUM
TYPE	LED DRIVER
OUTPUT POWER	151.2W
INPUT VOLTAGE OUTPUT	180-305V
VOLTAGE	24V
AMPERE (A)	6.3A
DIMENSIONS	L:191 x B:63 x H:37.5mm
APPLICATION	4 UNITS TOGETHER

E&OE MAY OCCUR

> SPECIAL EFFECTS

COMMERCIAL & ARCHITECTURAL

OUTDOOR - SPECIAL EFFECTS

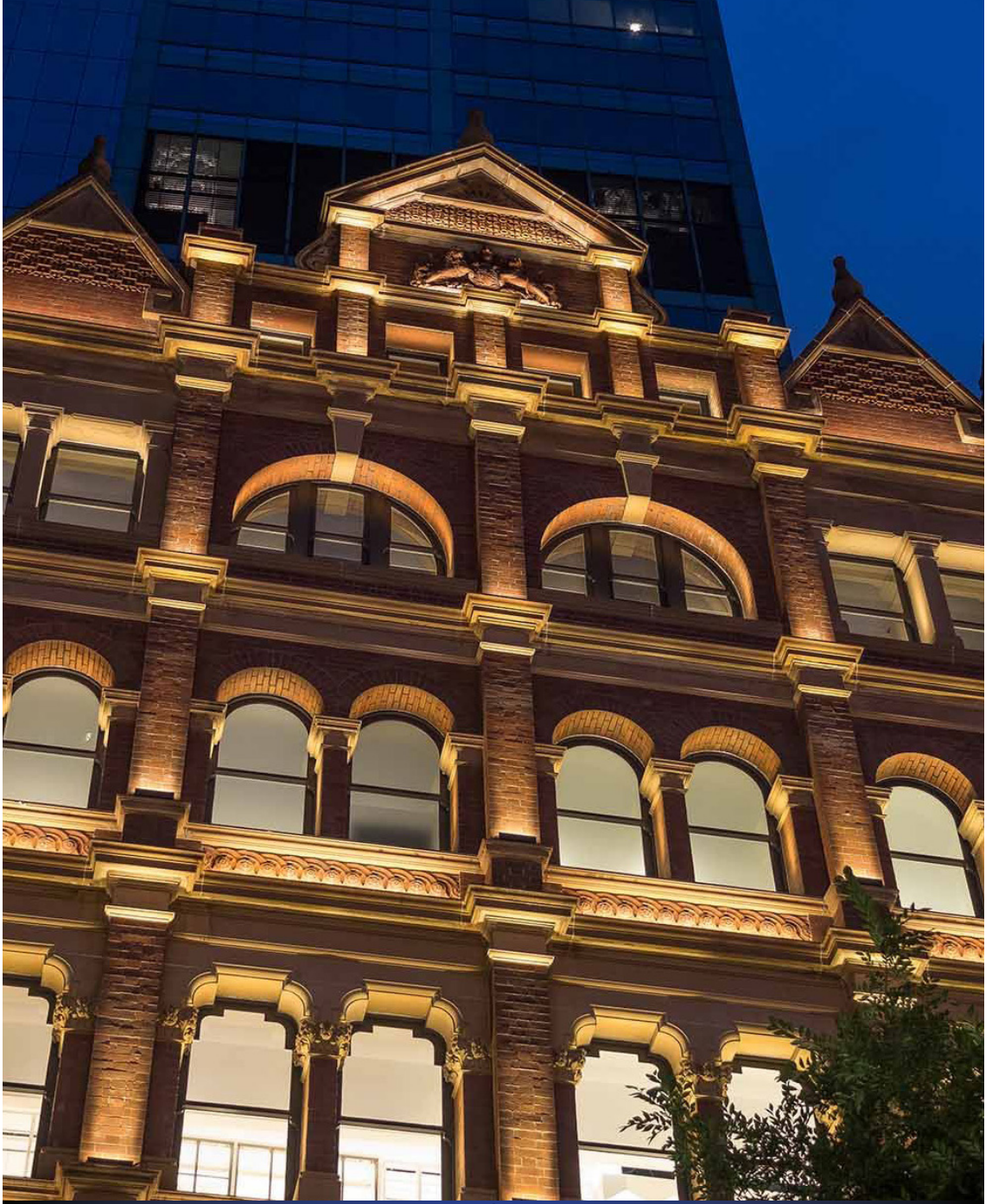

MITILO

SPECIAL EFFECTS

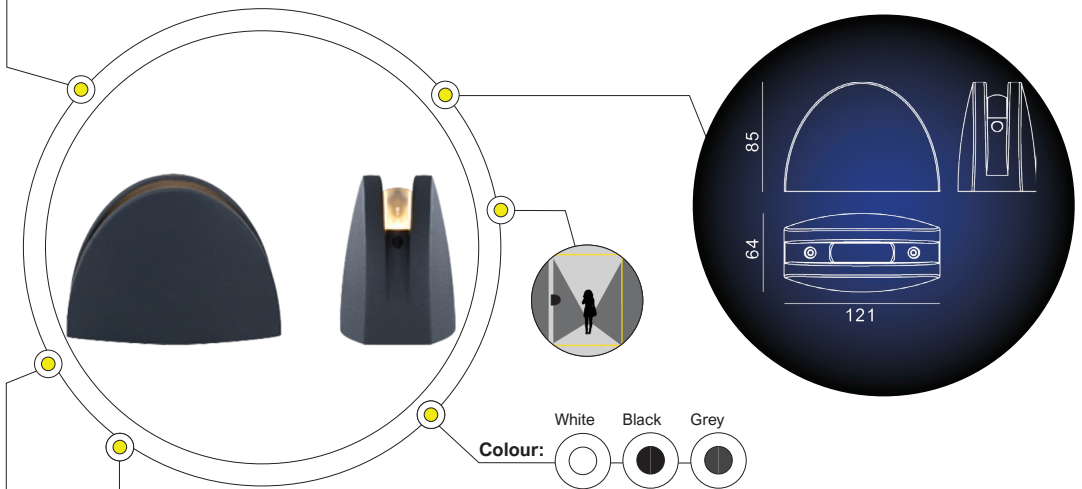

+ IP 65



LOA



ldt

PHYSICAL DATA

FEATURES

- Material: Aluminium
- MITILO - This lamp not only illuminates the space, but plays with light and shadow in an inspiring way
- This luminaire creates a sharp line of light, which expands over a radius of 180°; creating a dynamic lighting effect against the architecture of the space

MOUNTING

Surface

APPLICATION AREAS

Indoor, Outdoor, Commercial, Residential, Retail, Hospitality

TECHNICAL DATA

LF736917

LAMP	LED
TOTAL POWER (W)	6.1W
SYSTEM OUTPUT (LM)	390LM
CCT (K)	2700 / 3000K
CRI (Ra)	80
BEAM ANGLE	180°
OPERATING VOLTAGE-VAC	100-240V
SOURCE POWER (W)	8.8W
SOURCE OUTPUT (LM)	618LM
DIMENSIONS	L:121 x W:164 x H:85mm

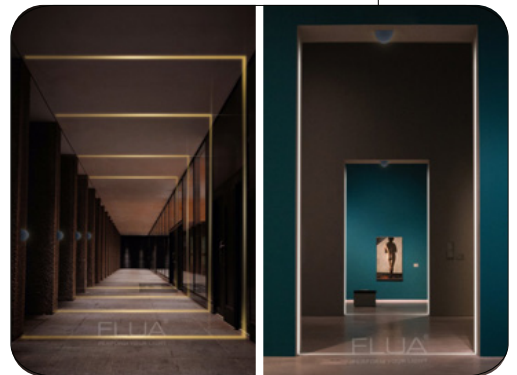

- CD / KLM
- C0 - C180
 - C90 - C270

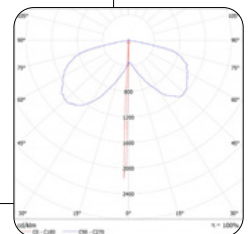

E&OE MAY OCCUR

TRICK RADIAL

SPECIAL EFFECTS

OUTDOOR – SPECIAL EFFECTS – TRICK RADIAL

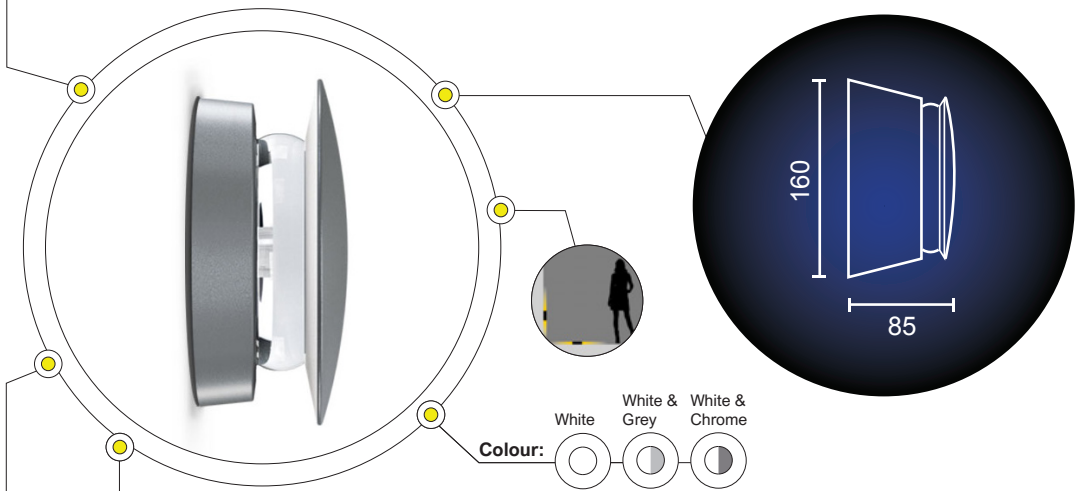

+IP
67



✓
5 YRS



PHYSICAL DATA

FEATURES

- Material: Phosphocromatization treated, die-cast aluminium with screen is made of methacrylate
- Design by Dean Skira
- Wall and ceiling-mounted luminaire, complete with ballast and designed for use with LED lamps and a patented 360° radial effect optic
- The product consists of a support base and screen
- High level of weather and UV ray resistance

- Compatible with lighting management systems
- Electronic transformer included

MOUNTING

Surface

APPLICATION AREAS

Indoor, Outdoor, Commercial, Residential, Retail, Hospitality

TECHNICAL DATA

BU23

LAMP	LED
TOTAL POWER (W)	11W
SYSTEM OUTPUT (LM)	528LM
EFFICACY (LM/W)	38.8
CCT (K)	3000K
CRI (RA)	80
BEAM ANGLE	360° RADIAL
OPERATING VOLTAGE	220-240V
SOURCE POWER (W)	13.6W
SOURCE OUTPUT (LM)	1650LM
OPERATING TEMP °C	-30°C to 50°C
CURRENT (MA)	350MA
IMPACT RATING (IK)	IK07
MACADAM STEP	3 SDCM
RATED LIFE (HRS)	50 000HRS @ 40°C
WEIGHT (KG)	1.15KG
DIMENSIONS	D:160 x W:85mm

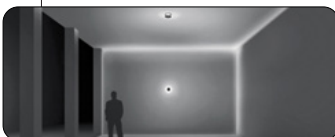

- CD / KLM
- C0 - C180
 - C90 - C270

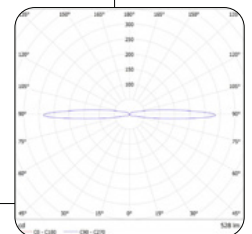

E&OE MAY OCCUR

> EMERGENCY

EMG EXIT SIGNS



BLADE LED

EXIT SIGNS

EMERGENCY - EMG EXIT SIGNS - LEMGE01

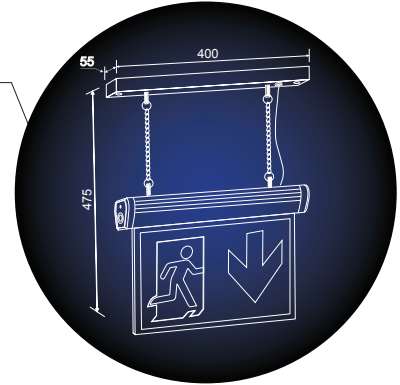
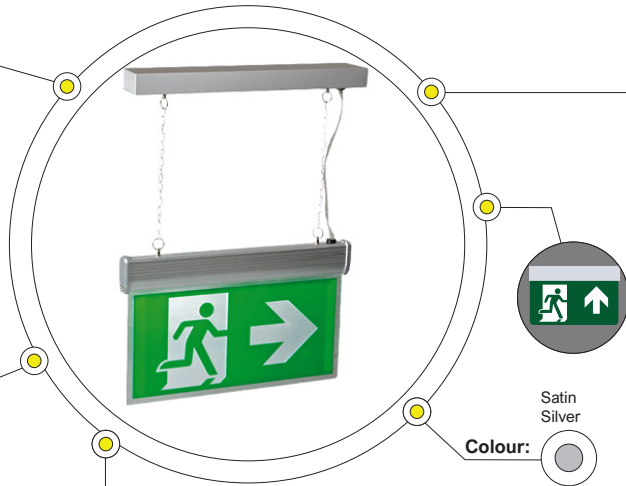

- + IP 20**
-
- LOA**
-
- 3 YRS**
- ldt**

PHYSICAL DATA

FEATURES

- Material: Blade body made from high quality aluminium profile and finished in satin silver
- Complete with 6 legend set
- First fix base with a simple "push on" electrical connector to the main body
- Modern solid state light source
- Provides look and feel of quality emergency signage solution

- All emergency route directions can be catered for
- Provides constant sign illumination for minimum 2-hours in emergency operation
- Signs can be seen from a distance of up to 48 meters

MOUNTING: Surface

APPLICATION AREAS

Indoor, Commercial, Residential, Retail, Hospitality

TECHNICAL DATA

LEMGE01

LAMP	LED
TOTAL POWER (W)	4W
CCT (K)	6000K
OPERATING VOLTAGE-VAC	220-240V
RATED LIFE (HRS)	50 000HRS
POWER FACTOR	0.9
WEIGHT (KG)	1.2KG
DISCHARGE DURATION	3HRS
LAMP DIMENSIONS	L:400 x W:53 x H:475mm



- CD / KLM
- C0 - C180
- C90 - C270

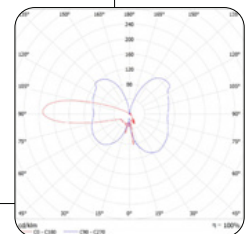

E&OE MAY OCCUR

LED EXIT BOX

EXIT SIGNS

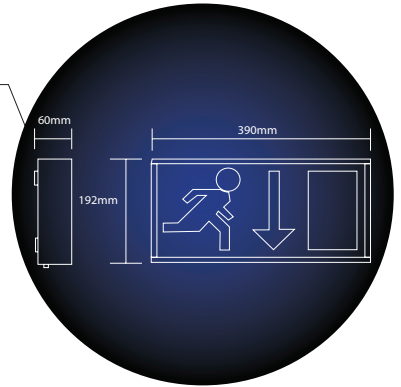

- + IP 20
-
- LOA**
- 3 YRS
- ldt**

PHYSICAL DATA

FEATURES

- Material: Pressed steel, powder-coated body with polystyrene diffuser
- Large, high-contrast legends providing maximum viewing distance of 30m
- Complete with running man legend with arrow up or down
- Two downward facing light windows that provides downward light to illuminate the area below the fitting for safe exit

OPTIONS & ACCESSORIES

- Self-test plug and play module available (REMSTU)
- Left and right legends available separately

MOUNTING

Surface

APPLICATION AREAS

Indoor, Commercial, Residential, Retail, Hospitality

TECHNICAL DATA

LEMGE023

LAMP	LED
TOTAL POWER (W)	3.8W
TOTAL OUTPUT (LM)	40LM
EFFICACY (LM/W)	11
CCT (K)	6500K
CRI (RA)	70
BEAM ANGLE	120°
OPERATING VOLTAGE-VAC	220-240V
RATED LIFE (HRS)	30 000HRS
POWER FACTOR	0.5
ILLUM @ 1M (LUX)	5
WEIGHT (KG)	1.2KG
DIMENSIONS	L:390 x W:60 x H:192mm

- CD / KLM
- C0 - C180
- C90 - C270

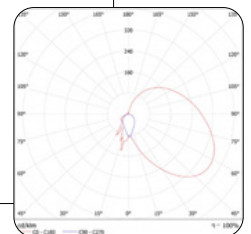

E&OE MAY OCCUR

SABS EXIT SIGN

EXIT SIGNS

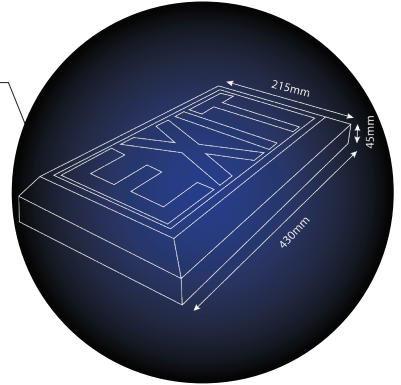

PHYSICAL DATA

+ IP 20

✓ 2 YRS

FEATURES

- LED lamps for high reliability
- 3 hours emergency duration
- The Emergency Exit Sign range of luminaires are ideally suited as stand-alone self contained single-sided, surface-mount fittings in new or existing buildings
- The LED arrangement provides a uniform illumination of the signs/legends with a high level of emergency

illumination at floor level, or at the threshold of an exit door

- An estimated 3 hours of emergency lighting is provided with the Ni-cad batteries

MOUNTING: Surface

APPLICATION AREAS

Indoor, Commercial, Residential, Retail, Hospitality

TECHNICAL DATA

LEMGE03

LAMP	LED
OPERATING VOLTAGE VAC	230VAC 50HZ
CHARGE CURRENT	150MA
DISCHARGE CURRENT	300MA
EMG LIGHTING DURATION	3HRS
BATTERY TYPE	5 x 2Ahr Nickel-Cadmium
MAX AMBIENT TEMP °C	+70°C
LEGEND HEIGHT	150mm
DIMENSIONS	L:430 x W:45 x H:215mm

EXIT SIGN

EXIT SIGNS

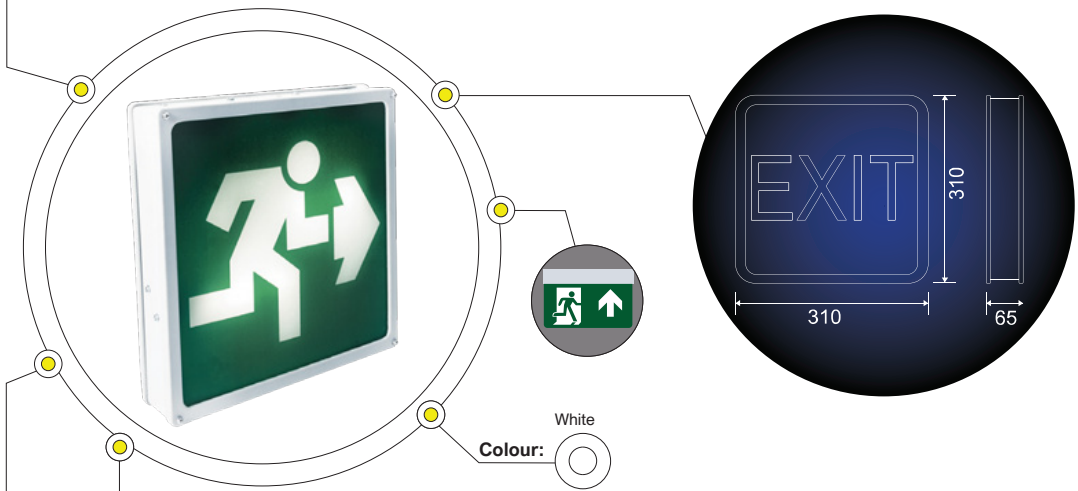

+ IP 20



2 YRS



PHYSICAL DATA

FEATURES

- Material: SMC Fiberglass frame
- Toughened glass lens - energy & environment friendly
- Galvanised hanging bolts
- Wall mount - Single sided
- Ceiling mount - Single or double sided
- Driver complete with non-dimmable

- ECL: Compact fluorescent lamp
- LED: Module / LED: EMG Module
- Electronic control gear
- EMG circuit: maintained or non-maintained

MOUNTING: Surface, Suspended

APPLICATION AREAS

Indoor, Commercial, Residential, Retail, Hospitality

OPTIONS & ACCESSORIES

TECHNICAL DATA

LEMGE04

LAMP	LED
TOTAL POWER (W)	2 x 9W
TOTAL OUTPUT (LM)	AS PER LAMP SPEC
CCT (K)	3000K - 7000K
OPERATING VOLTAGE-VAC	230V 50HZ
DIMENSIONS	L:310 x W:65 x H:310mm

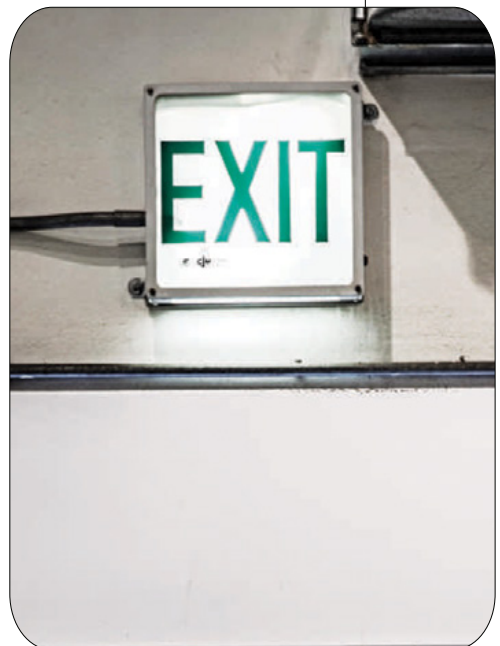

E&OE MAY OCCUR

SWISS BLADE

EXIT SIGNS

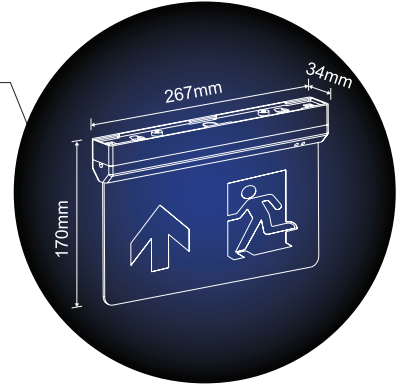

PHYSICAL DATA

FEATURES

- Material: Polycarbonate trim and housing
- Maintained exit blade with maximum 26m viewing distance visibility
- 3-hour emergency discharge
- Multiple versatile wall and ceiling surface mounting options (five-in-one). Includes one legend blade: running man into door with UP arrow
- Emergency exit blade light complete with 128mm height legend blade sign with running man into door
- Includes accessories for 5 mounting methods including

suspension wire mounted

OPTIONS & ACCESSORIES

- Additional legend decals available for DOWN and LEFT/RIGHT arrow (LEMGE09ACC and LEMGE09ACCLR)

MOUNTING: Surface- middle/parallel / perpendicular
Suspended mounted

APPLICATION AREAS

Indoor, Commercial, Residential, Retail, Hospitality

+ IP 20



LOA



4 YRS

ldt

TECHNICAL DATA

LEMGE091.531

LAMP	LED
TOTAL POWER (W)	1.4W
SYSTEM OUTPUT (LM)	6LM
EFFICACY	5
CCT (K)	6500K
CRI (Ra)	80
BEAM ANGLE	120°
OPERATING VOLTAGE-VAC	220-240V
OPERATING TEMP (°C)	-20°C to 40°C
RATED LIFE (HRS)	30 000HRS
POWER FACTOR	0.5
ILLUM @ 1M (LUX)	76
WEIGHT (KG)	0.21KG
DIMENSIONS	W:267 x D:34 x L:170mm

LEMGE09ACC LEMGE09ACCLR



CD / KLM

● C0 - C180

● C90 - C270

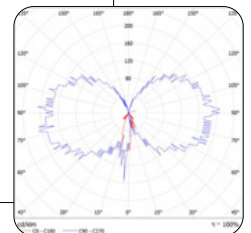

E&OE MAY OCCUR

> **EMG LIGHTS**

COMMERCIAL & ARCHITECTURAL



DYNAMO

EMERGENCY LIGHT

EMERGENCY - EMG LIGHTS - LEMG01

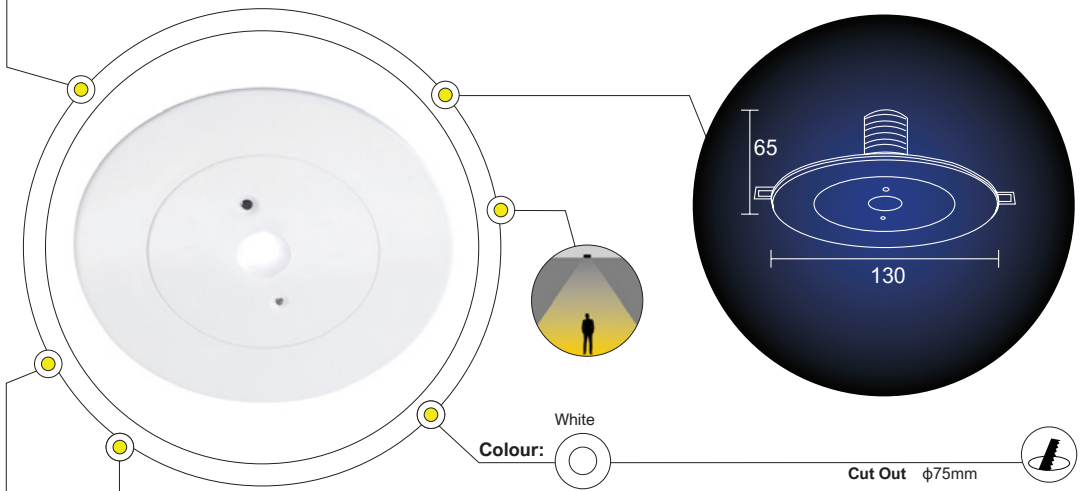

- + IP 20
-
- LOA
- 2 YRS
- Idt

PHYSICAL DATA

FEATURES

- Material: Die cast aluminium with polycarbonate trim
- Energy-efficient, non-maintained 2W recessed LED emergency fitting
- Complete kit pre-wired with plug & play connectors comprising LED downlight, controller and driver pack, battery pack
- Includes self test button and LED indicator
- Complete with extension bezel allowing mounting in

- cut outs of 75-110mm
- Provides 3hr emergency discharge duration
- Maximum spacing of 12m for mounting height of 2.8m

MOUNTING

Recessed

APPLICATION AREAS

Indoor, Commercial, Residential, Retail, Hospitality

TECHNICAL DATA

LEMG01

LAMP	LED
TOTAL POWER (W)	1.6W
SYSTEM OUTPUT (LM)	200LM
CCT (K)	6500K
CRI (RA)	75
BEAM ANGLE	150°
OPERATING VOLTAGE-VAC	220-240V
OPERATING TEMP (°C)	0°C to 40°C
RATED LIFE (HRS)	30 000HRS
POWER FACTOR	0.2
ILLUM @ 1M (LUX)	55
WEIGHT (KG)	0.71
DIMENSIONS	D:φ130 x H:65mm
CUT OUT	D:φ75mm

- CD / KLM
- C0 - C180
- C90 - C270

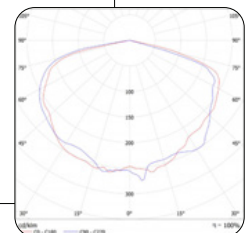

E&OE MAY OCCUR

CARINA

EMERGENCY DOWNLIGHT

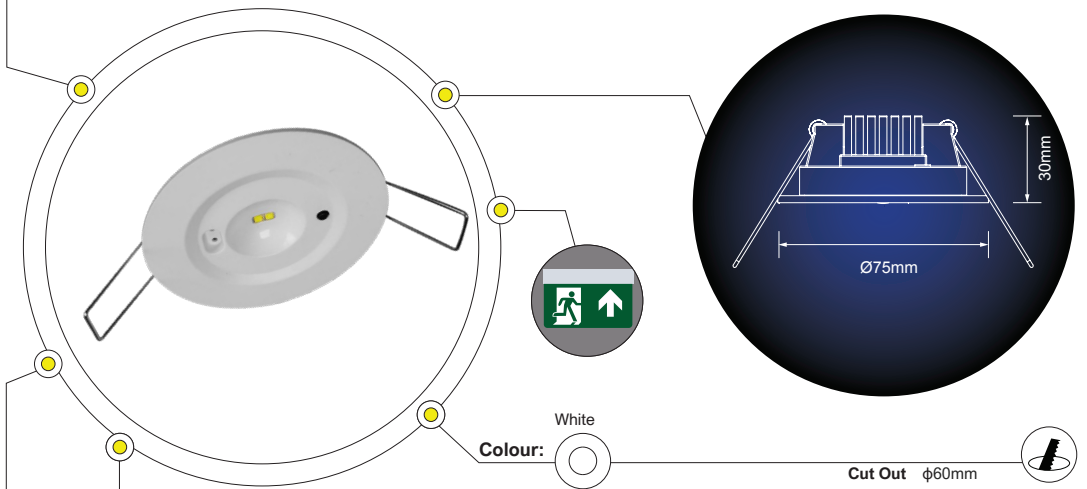

+ IP 20



LOA

3 YRS

ldt

PHYSICAL DATA

FEATURES

- Material: Polycarbonate housing, high-power LEDs and steel spring clips
- The ROBUS CARINA Emergency Downlight is a non-maintained luminaire with 320lm output
- Featuring self-test as default with the option to switch to standard emergency, if required
- Selectable between Manual Test facility and Self Test facility that fully automates testing and maintenance process

- LiFePO4 battery technology provides fast charge, a high number of charge/discharge cycles and a 3 hour emergency light output
- High lumen output, suitable for greater mounting heights
- Pre-flexed for easy install

MOUNTING: Recessed

APPLICATION AREAS

Indoor, Commercial, Residential, Retail, Hospitality

TECHNICAL DATA

RCN4STO-01

LAMP	LED
TOTAL POWER (W)	2.4W
SYSTEM OUTPUT (LM)	320LM
EFFICACY (LM/W)	133
CCT (K)	6500K
CRI (RA)	70
BEAM ANGLE	120°
OPERATING VOLTAGE-VAC	220-240V
OPERATING TEMP (°C)	-20°C to 40°C
RATED LIFE (HRS)	30 000HRS
POWER FACTOR	1
ILLUM @ 1M (LUX)	100
WEIGHT (KG)	0.25KG
DIMENSIONS	D:φ75 x H:30mm
CUT OUT	D:φ60mm

CD / KLM

● C0 - C180

● C90 - C270

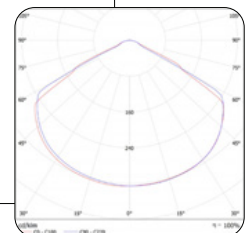

E&OE MAY OCCUR

DESMOND CORRIDOR

EMERGENCY DOWNLIGHT

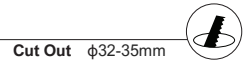
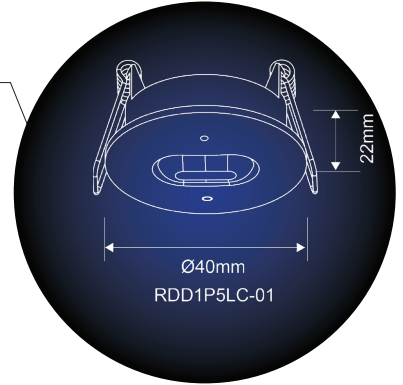
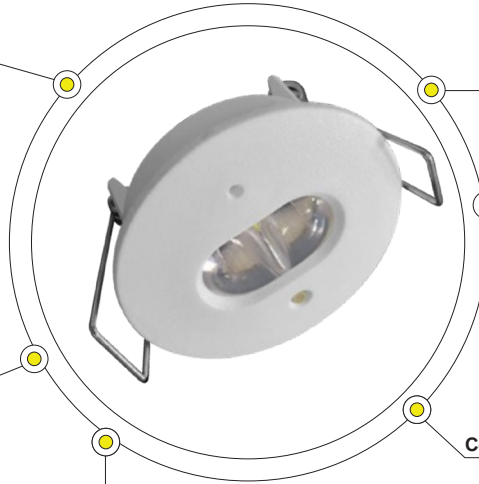

PHYSICAL DATA

+ IP 20



LOA

4 YRS

ldt

FEATURES

- Material: Downlight - white powder-coated die-cast aluminium housing with stainless steel retaining spring clip and polycarbonate lens. Control gear and battery pack - white polycarbonate housing
- Emergency downlight for the emergency lighting of corridors where the main lighting does not, or cannot incorporate integral emergency
- The corridor optic version provides a long and narrow beam characteristic for access or exit routes where most of the light is used usefully to light the route with little wasted

- on the walls
- Provides 3 hour emergency discharge duration

OPTIONS & ACCESSORIES

- The DESMOND OPEN available for the lighting of anti-panic areas (RDD1P5LO-01)

MOUNTING: Recessed

APPLICATION AREAS: Indoor, Commercial, Residential, Retail, Hospitality

TECHNICAL DATA

RDD1P5LC-01

LAMP	LED
TOTAL POWER (W)	1.4W
SYSTEM OUTPUT (LM)	170LM
EFFICACY (LM/W)	121
CCT (K)	5700K
CRI (RA)	70
BEAM ANGLE	170°
OPERATING VOLTAGE-VAC	220-240V
OPERATING TEMP (°C)	-20°C to 40°C
RATED LIFE (HRS)	40 000HRS
POWER FACTOR	0.39
ILLUM @ 1M (LUX)	30
WEIGHT (KG)	0.18KG
DIMENSIONS: DOWNLIGHT	L:173 x W:30 x H:22mm
CONTROL GEAR	D: ϕ 40 x H:22mm
CUT OUT	D: ϕ 32-35mm

CD / KLM

C0 - C180

C90 - C270

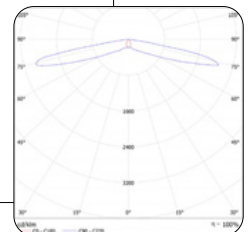

E&OE MAY OCCUR

DESMOND OPEN

EMERGENCY DOWNLIGHT

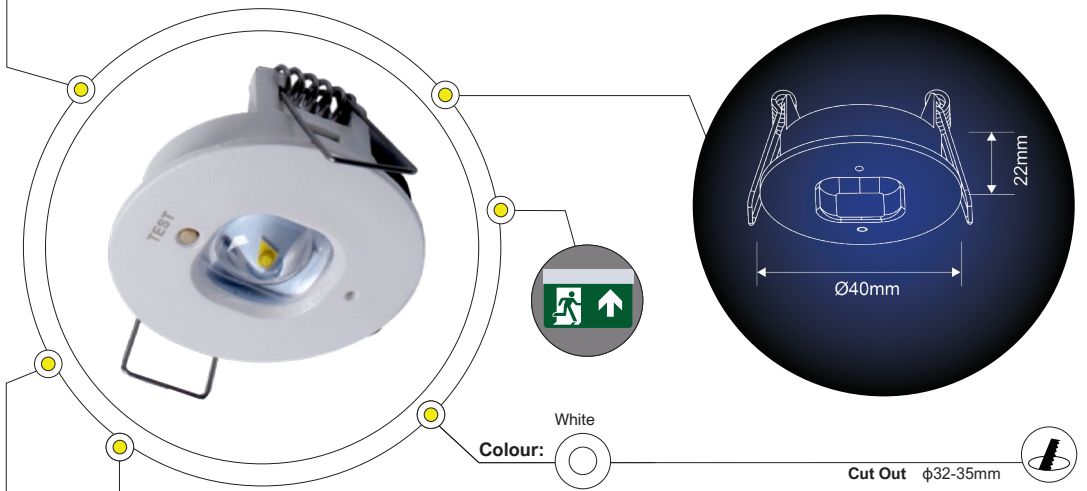

+ IP 20



LOA

4 YRS

ldt

PHYSICAL DATA

FEATURES

- Material: White polycarbonate body of the downlight and control gear
- The open area optic version provides general light coverage for larger or assembly areas where the main lighting does not, or cannot incorporate integral emergency
- Energy-efficient recessed LED emergency downlight with LiFePO4 battery for the emergency lighting of anti panic areas
- Complete kit pre-wired with plug & play connectors comprising LED downlight, control gear and battery pack

- Provides 3 hour emergency discharge duration; Green colour LED Indicator included

OPTIONS & ACCESSORIES

- The DESMOND CORRIDOR available for the emergency lighting of corridors (RDD1P5LC-01)

MOUNTING: Recessed

APPLICATION AREAS: Indoor, Commercial, Residential, Retail, Hospitality

TECHNICAL DATA

RDD1P5LO-01

LAMP	LED
TOTAL POWER (W)	1.3W
SYSTEM OUTPUT (LM)	170LM
EFFICACY (LM/W)	121
CCT (K)	5700K
CRI (RA)	70
BEAM ANGLE	140°
OPERATING VOLTAGE-VAC	220-240V
OPERATING TEMP (°C)	-20°C to 40°C
RATED LIFE (HRS)	40 000HRS
POWER FACTOR	0.39
ILLUM @ 1M (LUX)	20
WEIGHT (KG)	0.18KG
DIMENSIONS: DOWNLIGHT	L:173 x W:30 x H:22mm
CONTROL GEAR	D:φ40 x H:22mm
CUT OUT	D:φ32-35mm

- CD / KLM
- C0 - C180
 - C90 - C270

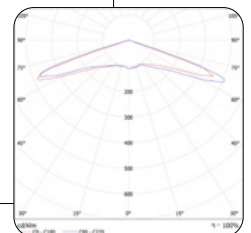

E&OE MAY OCCUR

> EMG BATTERY PACKS

COMMERCIAL & ARCHITECTURAL



LED UNIVERSE

LED EMERGENCY GEAR

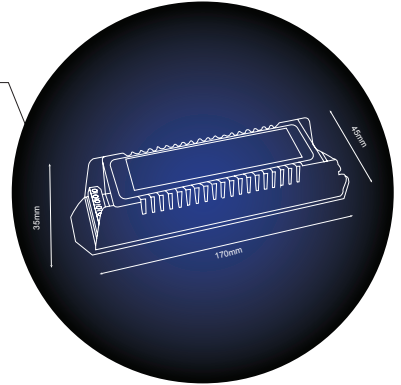

+ IP 20

✓
3 YRS

PHYSICAL DATA

FEATURES

- LED emergency kit for modules or panels with external drivers; Ni-cad and lithium-ion battery compatible
- It can operate any LED's that has a forward voltage of 10 to 300V DC
- Lithium-ion Batteries offer better efficiency for emergency lighting; the batteries are smaller in size with higher capacity
- The LED Universe with lithium-ion batteries can offer longer duration during emergency mode with an added advantage of being cost-efficient

OPTIONS & ACCESSORIES

- If the emergency control gear cannot fit into the luminaire, due to size or temperature, the emergency control gear can be supplied in a remote box
- Higher-capacity LED emergency gears available
- Plastic, Slim or Low-Profile Housing available for selection

MOUNTING: With LED Drivers (external)

APPLICATION AREAS

Indoor, Commercial, Residential, Hospitality, Retail

TECHNICAL DATA

LED UNIVERSE

RATED SUPPLY VOLTAGE	110-250VAC
MAINS FREQUENCY	50HZ
OUTPUT VOLTAGE RANGE	10-300V
DISCHARGE CURRENT	2A (max)
BATTERY CHARGING TIME	24H
AMBIENT TEMP °C (TA)	+55°C
MAX CASING TEMP °C	70°C
DIMENSIONS	L:170 x W:45 x H:35mm

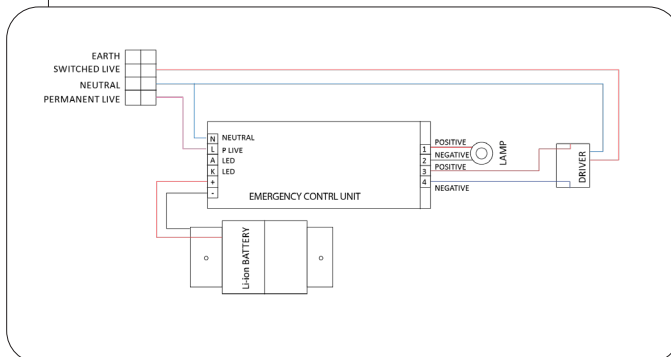

E&OE MAY OCCUR

LED UNIVERSE DELTA

LED EMERGENCY GEAR

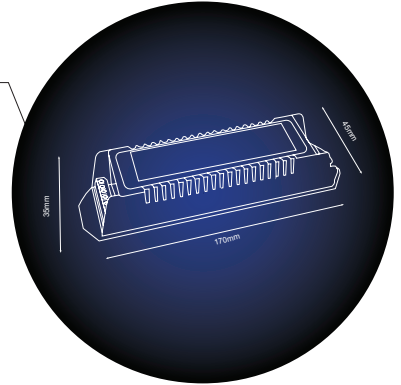
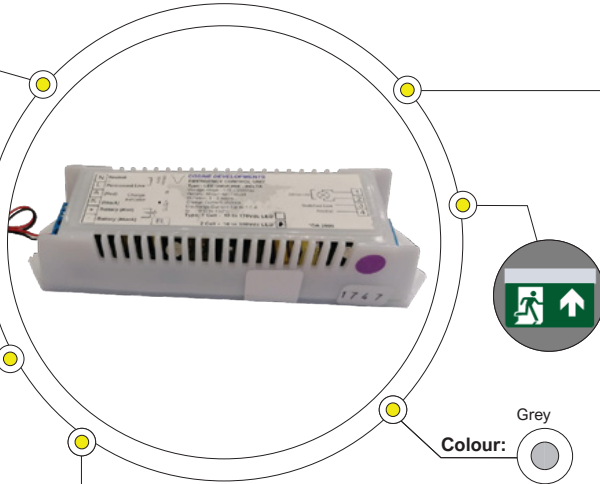

Colour: 

+ IP 20

✓ 3 YRS

PHYSICAL DATA

FEATURES

- LED emergency kit for modules or panels with on-board drivers
- Ni-Cad and lithium-ion battery compatible
- It can operate LED's that has a forward voltage of 10 to 300Vdc with internal circuits using low currents. Please note that loads must be tested for compatibility before use
- Lithium-ion batteries offer better efficiency for emergency lighting. The LED Universe with lithium-ion batteries can offer longer duration emergency mode with an added advantage of being cost-efficient

OPTIONS & ACCESSORIES

- If the emergency control gear cannot fit into the luminaire, due to size or temperature, the emergency control gear can be supplied in a remote box
- Higher-capacity LED emergency gears available
- Plastic, Slim or Low-Profile Housing available for selection

MOUNTING: With LED Drivers (external)

APPLICATION AREAS

Indoor, Commercial, Residential, Hospitality, Retail

TECHNICAL DATA

LED UNIVERSE DELTA

RATED SUPPLY VOLTAGE	100-253VAC
MAINS FREQUENCY	50HZ
OUTPUT VOLTAGE RANGE	10-300V
DISCHARGE CURRENT	2A (max)
BATTERY CHARGING TIME	24H
AMBIENT TEMP °C (TA)	+55°C
MAX CASING TEMP °C	70°C
DIMENSIONS	L:170 x W:45 x H:35mm

> LAMPS

COMMERCIAL & ARCHITECTURAL

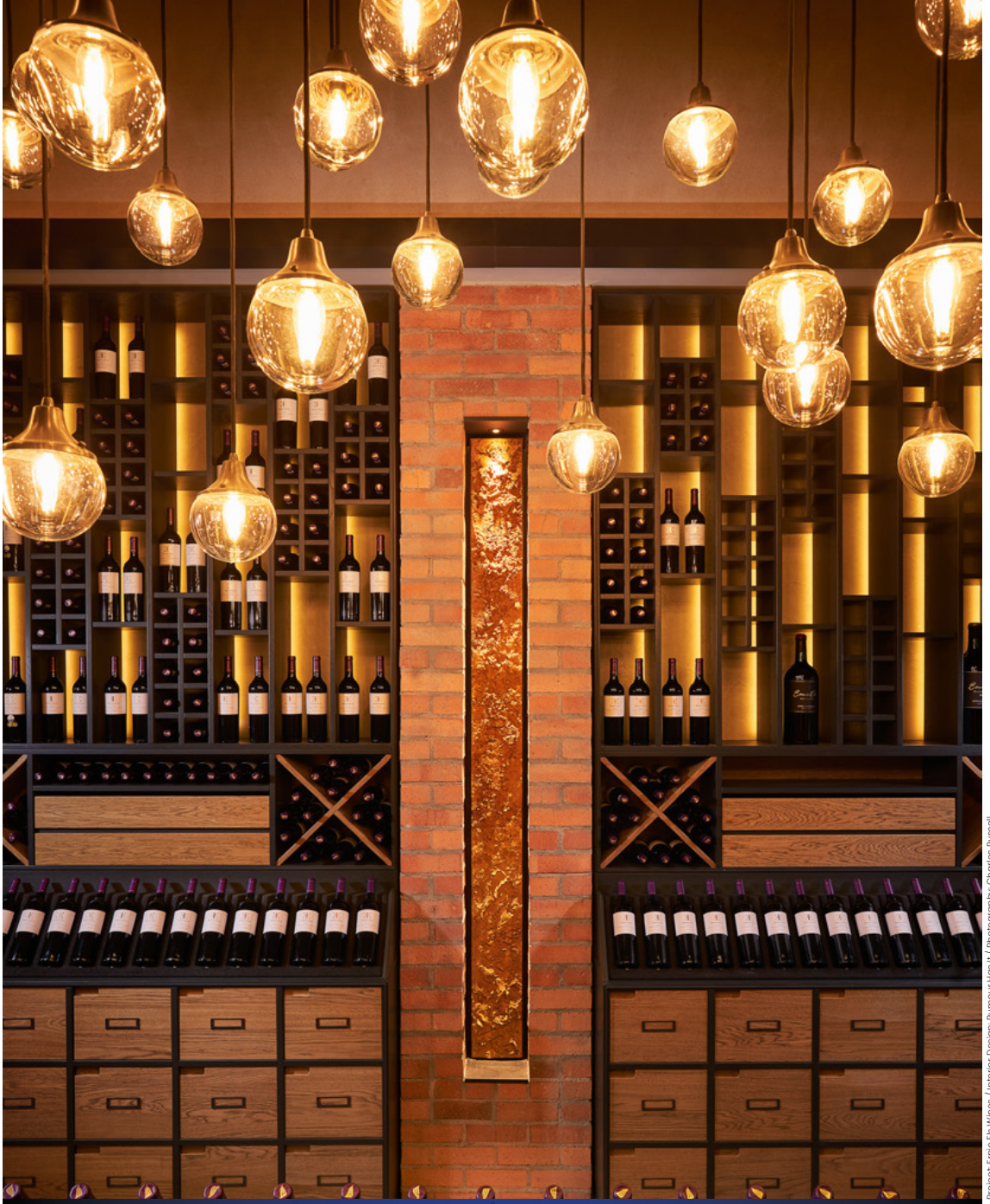

LPPAR165036

**DIMMABLE
GU10 LAMP**

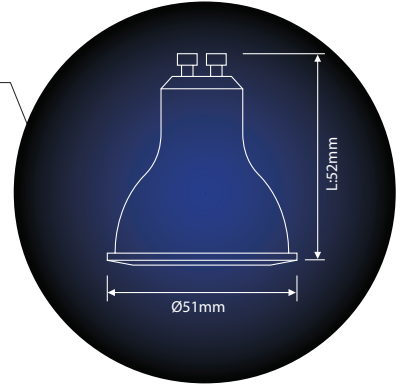
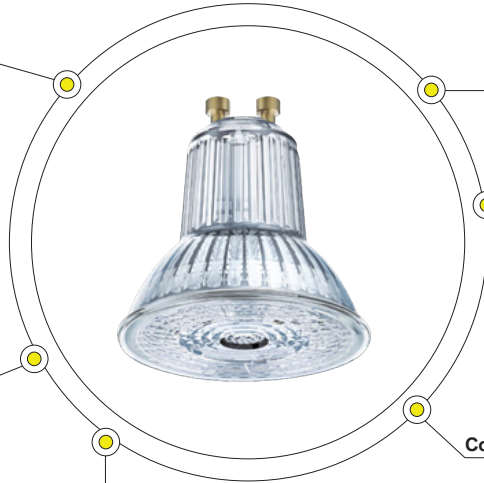

PHYSICAL DATA



FEATURES

- Material: Glass casing material
- Easy replacement of halogen lamps due to compact full glass design and single optic
- TruWave Technology which can offer more natural and comfortable light
- Premium light quality thanks to high color rendering index and narrow binning
- Dimming towards your ideal ambience

- Very high color rendering and long lifetime

MOUNTING

as per lamp specifications

APPLICATION AREAS

Indoor, Commercial, Residential, Retail, Hospitality

TECHNICAL DATA

LPPAR165036

LAMP	LED
DIMMABLE	YES
BASE	GU10
TOTAL POWER (W)	5.5W
SYSTEM OUTPUT (LM)	380 / 400LM
CCT (K)	3000 / 4000 / 6500K
CRI (Ra)	90
BEAM ANGLE	36°
OPERATING VOLTAGE-VAC	230V
RATED LIFE (HRS)	25 000HRS
POWER FACTOR	0.7
MAC ADAM STEP	<5 SDCM
CURRENT(MA)	33MA
WEIGHT (KG)	0.041KG
DIMENSIONS	D:φ51 x H:52mm

DELPHI 5W LED GU10 LAMP

**DIMMABLE
GU10 LAMP**

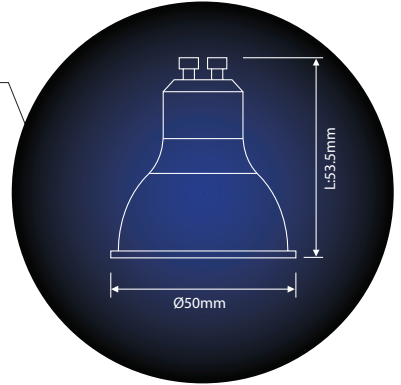
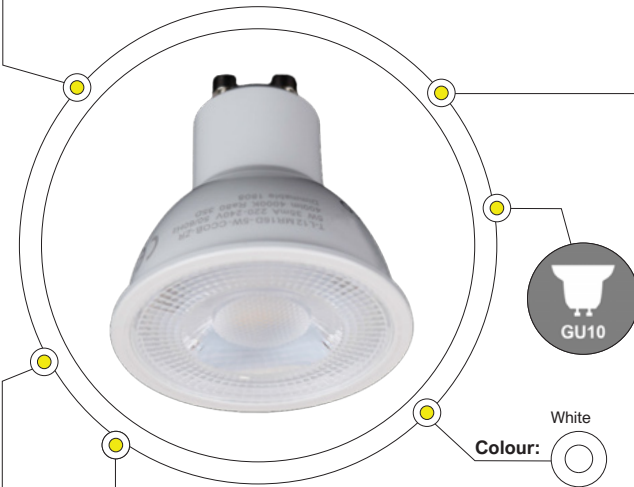

LAMPS - DELPHI

- + IP 20**
-
- 2 YRS**
- ldt**

PHYSICAL DATA

FEATURES

- Material: Die cast aluminium, plastic coated housing and polycarbonate lens
- Heat Dissipating Polycarbonate maintains lamp temperature is not exceeded and to provide a long life
- Lens and diffuser provides a twinkling aesthetic
- Emits minimum heat and no ultra violet in the light beam so less cooling is required and is less attractive to flying insects
- Dimmable with selected leading and trailing edge dimmers

- Suitable for switching by PIR, Microwave or Photocell

OPTIONS & ACCESSORIES

- Available in 4.5W dimmable and non-dimmable versions
- 2700K or 4000K versions available

MOUNTING: as per lamp specifications

APPLICATION AREAS: Indoor, Commercial, Residential, Retail, Hospitality

TECHNICAL DATA

RDH5P030DU

LAMP	LED
DIMMABLE	SHUTTLE DIM
BASE	GU10
TOTAL POWER (W)	5.9W
SYSTEM OUTPUT (LM)	450LM
EFFICACY (LM/W)	92
CCT (K)	3000K
CRI (Ra)	80
BEAM ANGLE	35°
OPERATING VOLTAGE-VAC	220-240V
OPERATING TEMP °C	-20°C to +40°C
RATED LIFE (HRS)	25 000HRS
POWER FACTOR	0.9
ILLUM @1M (LUX)	710LX
WEIGHT (KG)	0.04KG
DIMENSIONS	D:φ50 x H:53.5mm

SHUTTLE DIM DATA

SDIM-L-LED-125/500

TYPE	BELL PRESS DIMMER
DIMMING METHOD	LEADING OR TRAILING EDGE
MIN LOAD POWER	125W and 500W
DIMENSIONS	125W: 36 x 36 x 12mm 500W: 42 x 42 x 13mm

- CD / KLM
- C0 - C180
- C90 - C270

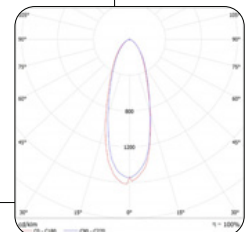

E&OE MAY OCCUR

CLEAR FILAMENT LED GLOBE

GLS CLEAR GLOBE

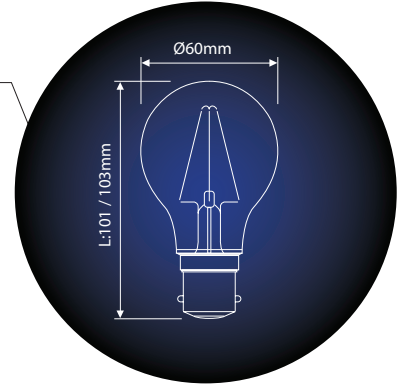
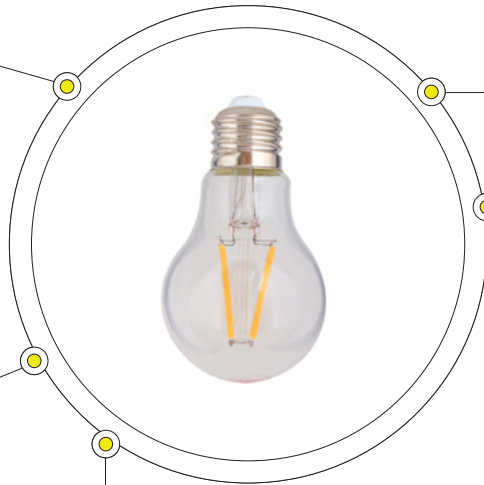

PHYSICAL DATA

+ IP 20



2 YRS

FEATURES

- Clear LED GLS filament globe
- Non-dimmable

OPTIONS & ACCESSORIES

- Base available for selection: B22 and E27

MOUNTING

as per lamp specifications

APPLICATION AREAS

Indoor, Commercial, Residential, Retail, Hospitality

TECHNICAL DATA

G959

G958

LAMP	LED	LED
DIMMABLE	NO	NO
BASE	E27	B22
TOTAL POWER (W)	4W	4W
SYSTEM OUTPUT (LM)	360LM	360LM
CCT (K)	3000K	3000K
CRI (Ra)	80	80
BEAM ANGLE	360°	360°
OPERATING VOLTAGE-VAC	220-240V	220-240V
RATED LIFE (HRS)	15 000HRS	15 000HRS
DIMENSIONS	D:φ60 X H:101mm	D:φ60 X H:103mm

SOFT HUE FILAMENT GLOBE

GLS SOFT HUE GLOBE

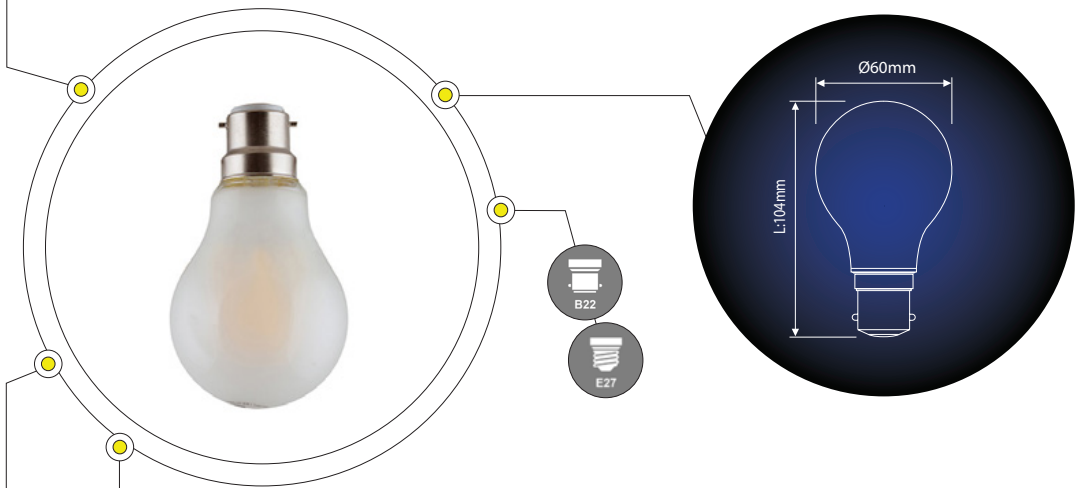

+ IP 20



2 YRS

PHYSICAL DATA

FEATURES

- Soft-hue LED filament globe
- Produces a warm, soft light that is gentle on the eye and perfect for decorative luminaires, such as bedside lamps
- Non-dimmable

MOUNTING

as per lamp specifications

APPLICATION AREAS

Indoor, Commercial, Residential, Retail, Hospitality

OPTIONS & ACCESSORIES

- Base available for selection: B22 and E27

TECHNICAL DATA

G512ES

G512BC

LAMP	LED	LED
DIMMABLE	NO	NO
BASE	E27	B22
TOTAL POWER (W)	6W	6W
SYSTEM OUTPUT (LM)	620LM	620LM
CCT (K)	2900K	2900K
CRI (Ra)	80	80
BEAM ANGLE	300°	300°
OPERATING VOLTAGE-VAC	220-240V	220-240V
RATED LIFE (HRS)	15 000HRS	15 000HRS
DIMENSIONS	D:φ60 X H:104mm	D:φ60 X H:104mm

DIMMABLE LED FILAMENT CANDLE

DIMMABLE
FILAMENT CANDLE

LAMPS - DIMMABLE FILAMENT CANDLE

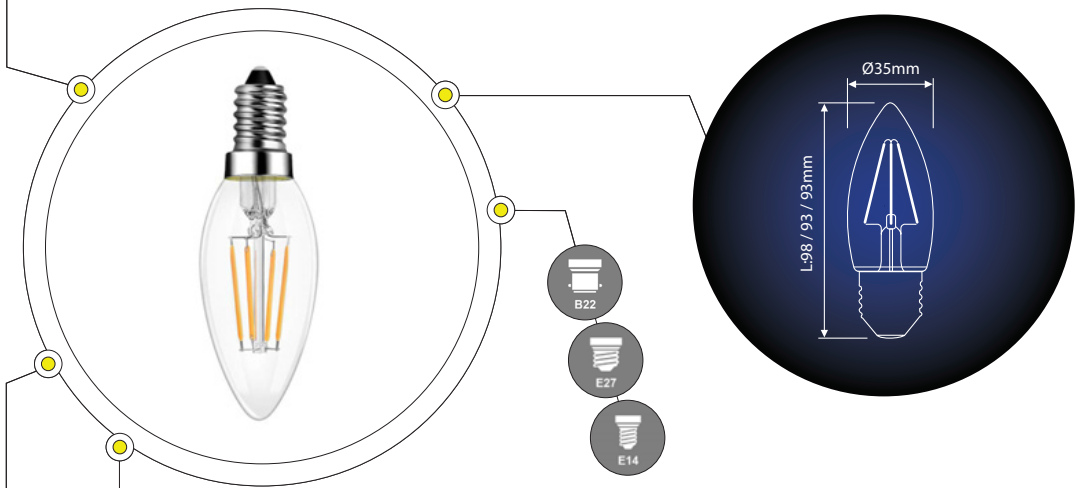

+ IP 20



2 YRS

PHYSICAL DATA

FEATURES

- Dimmable LED clear filament candle
- Please ensure that the minimum load requirement of each respective dimmer is adhered to
- Ensure the dimming module is compatible with the lamp

LED Trailing Edge Rotary Dimmer
LED Trailing Edge Push Button Dimmer

MOUNTING

as per lamp specifications

OPTIONS & ACCESSORIES

- Base available for selection: B22, E27 and E14
- Dimmer modules available:

APPLICATION AREAS

Indoor, Commercial, Residential, Retail, Hospitality

TECHNICAL DATA

G639SES

G639ES

G639BC

LAMP	LED	LED	LED
DIMMABLE	YES	YES	YES
BASE	E14	E27	B22
TOTAL POWER (W)	4W	4W	4W
SYSTEM OUTPUT (LM)	400LM	400LM	400LM
CCT (K)	3000K	3000K	3000K
CRI (Ra)	80	80	80
BEAM ANGLE	350°	350°	350°
OPERATING VOLTAGE-VAC	230V	230V	230V
RATED LIFE (HRS)	15 000HRS	15 000HRS	15 000HRS
DIMENSIONS	D:φ35 X H:98mm	D:φ35 X H:93mm	D:φ35 X H:93mm

SHUTTLE DIM DATA

SDIM-L-LED-125/500

TYPE	BELL PRESS DIMMER
DIMMING METHOD	LEADING OR TRAILING EDGE
MIN LOAD POWER	125W and 500W
DIMENSIONS	125W: 36 x 36 x 12mm 500W: 42 x 42 x 13mm

SOFT HUE FILAMENT CANDLE

SOFT HUE
FILAMENT CANDLE

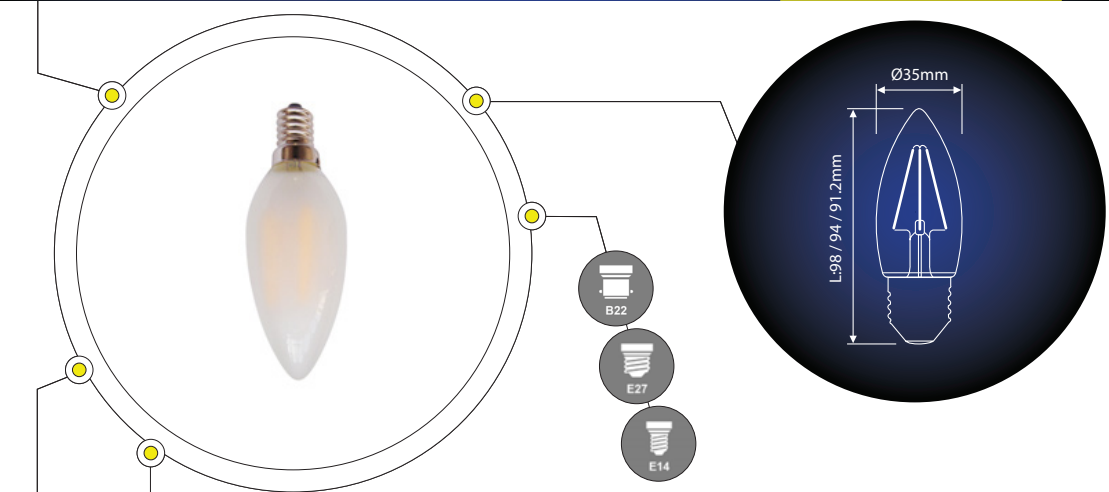

+ IP
20



✓
2 YRS

PHYSICAL DATA

FEATURES

- Soft-hue LED frosted filament candle
- Produces a warm, soft light that is gentle on the eye and perfect for decorative luminaires, such as bedside lamp
- Non-dimmable

MOUNTING

as per lamp specifications

APPLICATION AREAS

Indoor, Commercial, Residential, Retail, Hospitality

OPTIONS & ACCESSORIES

- Base available for selection: B22, E27 and E14

TECHNICAL DATA

G510SES

G510ES

G510BC

LAMP	LED	LED	LED
DIMMABLE	YES	YES	YES
BASE	E14	E27	B22
TOTAL POWER (W)	4W	4W	4W
SYSTEM OUTPUT (LM)	400LM	400LM	400LM
CCT (K)	2900K	2900K	2900K
CRI (Ra)	80	80	80
BEAM ANGLE	350°	350°	350°
OPERATING VOLTAGE-VAC	230V	230V	230V
RATED LIFE (HRS)	15 000HRS	15 000HRS	15 000HRS
DIMENSIONS	D:φ35 X H:98mm	D:φ35 X H:94mm	D:φ35 X H:91.2mm

CLEAR FILAMENT FLAME CANDLE

CLEAR FILAMENT
FLAME CANDLE

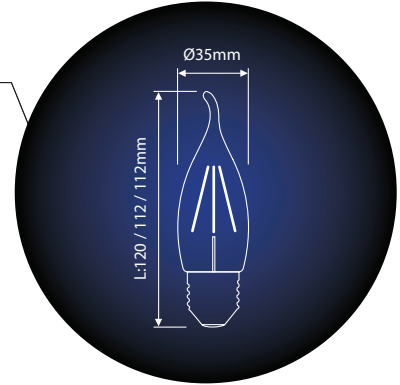
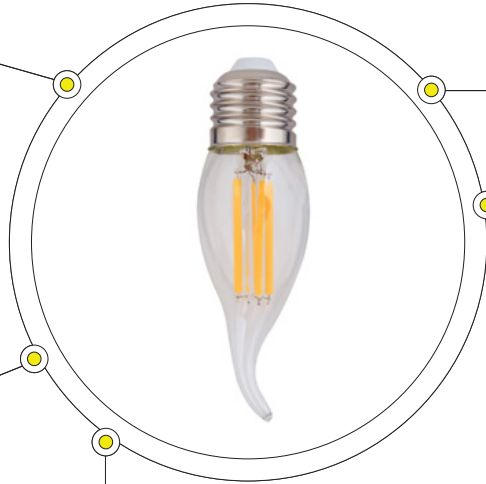

PHYSICAL DATA

+ IP 20



2 YRS

FEATURES

- Clear LED filament flame candle
- Non-dimmable

OPTIONS & ACCESSORIES

- Base available for selection: B22, E27 and E14

MOUNTING

as per lamp specifications

APPLICATION AREAS

Indoor, Commercial, Residential, Retail, Hospitality

TECHNICAL DATA

G970

G971

G972

LAMP	LED	LED	LED
DIMMABLE	NO	NO	NO
BASE	E14	E27	B22
TOTAL POWER (W)	4W	4W	4W
SYSTEM OUTPUT (LM)	310LM	310LM	310LM
CCT (K)	3000K	3000K	3000K
CRI (Ra)	80	80	80
BEAM ANGLE	360°	360°	360°
OPERATING VOLTAGE-VAC	230V	230V	230V
RATED LIFE (HRS)	15 000HRS	15 000HRS	15 000HRS
DIMENSIONS	D:φ35 X H:120mm	D:φ35 X H:112mm	D:φ35 X H:112mm

DIMMABLE FILAMENT T64 SPIRAL

**DIMMABLE FILAMENT
T64 SPIRAL**

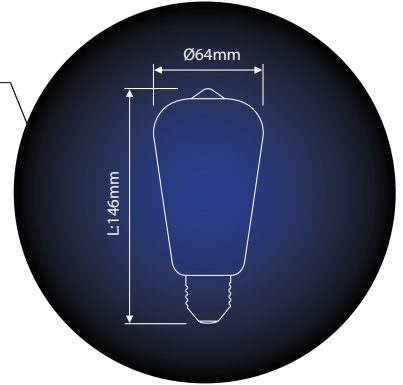
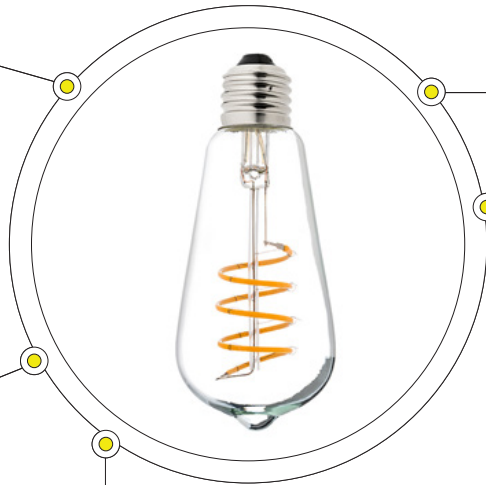

+ IP 20



✓ 1 YR

PHYSICAL DATA

FEATURES

- Clear LED filament balloon spiral T64 bulb
- Dimmable

OPTIONS & ACCESSORIES

- Base available for selection: E27

MOUNTING

as per lamp specifications

APPLICATION AREAS

Indoor, Commercial, Residential, Retail, Hospitality

TECHNICAL DATA

HX-LSAST64-4W

LAMP	LED
DIMMABLE	YES
BASE	E27
TOTAL POWER (W)	4W
SYSTEM OUTPUT (LM)	340-360LM
CCT (K)	2200K
CRI (Ra)	80
BEAM ANGLE	360°
OPERATING VOLTAGE-VAC	240V
RATED LIFE (HRS)	15 000HRS
DIMENSIONS	D:φ64 X H:146mm

SHUTTLE DIM DATA

SDIM-L-LED-125/500

TYPE	BELL PRESS DIMMER
DIMMING METHOD	LEADING OR TRAILING EDGE
MIN LOAD POWER	125W and 500W
DIMENSIONS	125W: 36 x 36 x 12mm 500W: 42 x 42 x 13mm

DIMMABLE FILAMENT G80 SPIRAL

**DIMMABLE FILAMENT
G80 SPIRAL**

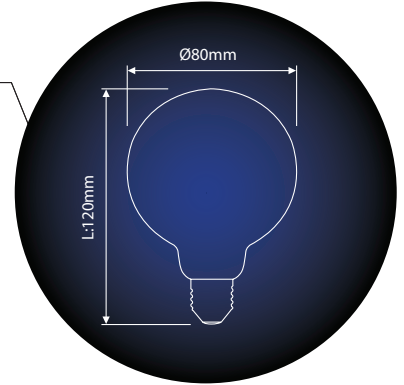
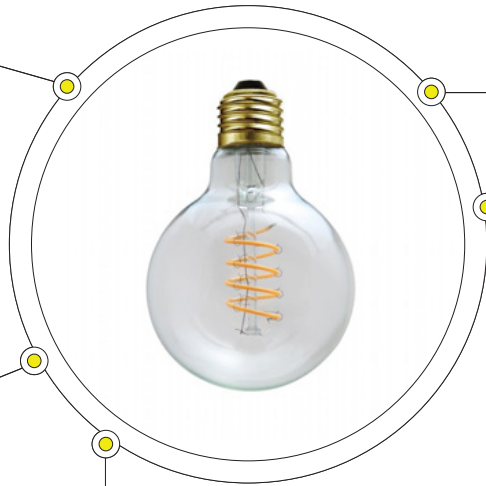

PHYSICAL DATA

FEATURES

- Clear LED G80 ball spiral filament maxi bulb
- Dimmable

OPTIONS & ACCESSORIES

- Base available for selection: E27

MOUNTING

as per lamp specifications

APPLICATION AREAS

Indoor, Commercial, Residential, Retail, Hospitality

+ IP
20



✓
1 YR

TECHNICAL DATA

HX-LSG80-4W

LAMP	LED
DIMMABLE	YES
BASE	E27
TOTAL POWER (W)	4W
SYSTEM OUTPUT (LM)	300 - 320LM
CCT (K)	2200K
CRI (Ra)	80
BEAM ANGLE	360°
OPERATING VOLTAGE-VAC	240V
RATED LIFE (HRS)	15 000HRS
DIMENSIONS	D:φ80 X H:120mm

SHUTTLE DIM DATA

SDIM-L-LED-125/500

TYPE	BELL PRESS DIMMER
DIMMING METHOD	LEADING OR TRAILING EDGE
MIN LOAD POWER	125W and 500W
DIMENSIONS	125W: 36 x 36 x 12mm 500W: 42 x 42 x 13mm

LAMPS - DIMMABLE FILAMENT G80 SPIRAL

DIMMABLE FILAMENT G125 AMBER

**DIMMABLE FILAMENT
SPIRAL G125 AMBER**

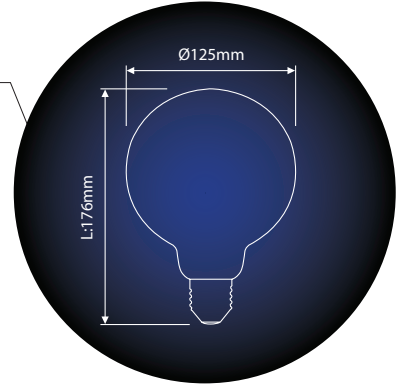

+ IP
20



✓
1 YR

PHYSICAL DATA

FEATURES

- LED G125 wonky amber filament bulb
- Spiral filament
- Dimmable

OPTIONS & ACCESSORIES

- Base available for selection: E27

MOUNTING

as per lamp specifications

APPLICATION AREAS

Indoor, Commercial, Residential, Retail, Hospitality

TECHNICAL DATA

UF-L04920-D/AB

LAMP	LED
DIMMABLE	YES
BASE	E27
TOTAL POWER (W)	4W
SYSTEM OUTPUT (LM)	140LM
CCT (K)	2200K
CRI (Ra)	80
BEAM ANGLE	360°
OPERATING VOLTAGE-VAC	240V
RATED LIFE (HRS)	15 000HRS
DIMENSIONS	D:φ125 X H:176mm

SHUTTLE DIM DATA

SDIM-L-LED-125/500

TYPE	BELL PRESS DIMMER
DIMMING METHOD	LEADING OR TRAILING EDGE
MIN LOAD POWER	125W and 500W
DIMENSIONS	125W: 36 x 36 x 12mm 500W: 42 x 42 x 13mm

DIMMABLE FILAMENT G125 SMOKE

**DIMMABLE FILAMENT
SPIRAL G125 SMOKE**

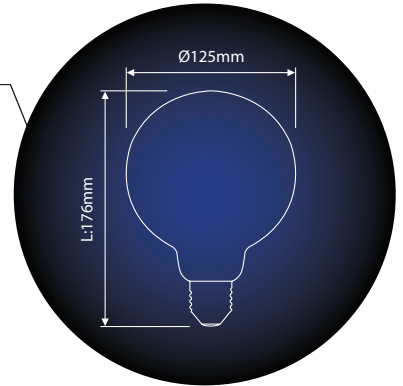

PHYSICAL DATA

FEATURES

- LED G125 wonky smoke filament bulb
- Spiral filament
- Dimmable

OPTIONS & ACCESSORIES

- Base available for selection: E27

MOUNTING

as per lamp specifications

APPLICATION AREAS

Indoor, Commercial, Residential, Retail, Hospitality



TECHNICAL DATA

UF-L04920-D/SM

LAMP	LED
DIMMABLE	YES
BASE	E27
TOTAL POWER (W)	4W
SYSTEM OUTPUT (LM)	140LM
CCT (K)	2200K
CRI (Ra)	80
BEAM ANGLE	360°
OPERATING VOLTAGE-VAC	240V
RATED LIFE (HRS)	15 000HRS
DIMENSIONS	D:φ125 X H:176mm

SHUTTLE DIM DATA

SDIM-L-LED-125/500

TYPE	BELL PRESS DIMMER
DIMMING METHOD	LEADING OR TRAILING EDGE
MIN LOAD POWER	125W and 500W
DIMENSIONS	125W: 36 x 36 x 12mm 500W: 42 x 42 x 13mm

LAMPS - DIMMABLE FILAMENT SPIRAL G125 SMOKE

DIMMABLE LARGE PEAR A165 AMBER

**DIMMABLE WONKY
LARGE PEAR A165 AMBER**

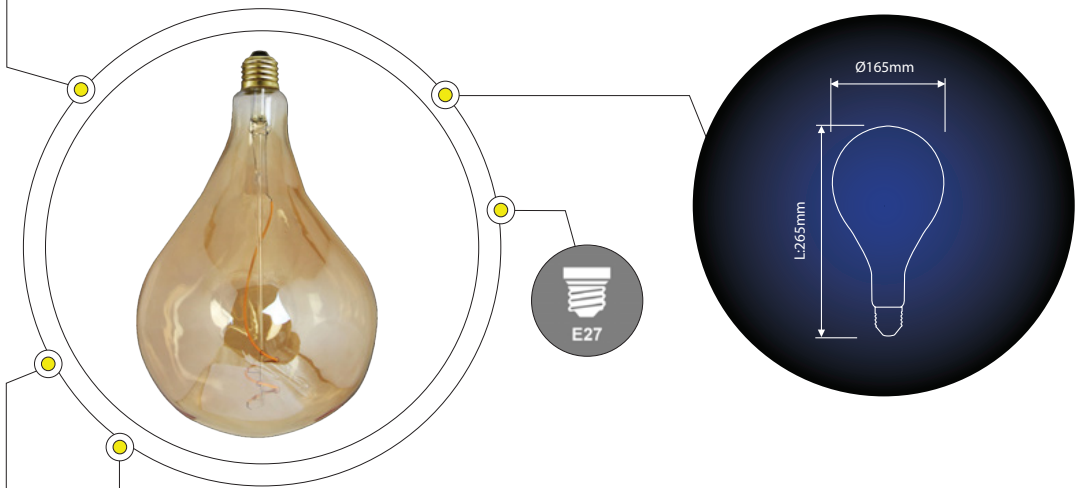

+ IP 20



✓ 1 YR

PHYSICAL DATA

FEATURES

- LED A165 wonky large pear amber filament bulb
- Spiral filament
- Dimmable

OPTIONS & ACCESSORIES

- Base available for selection: E27

MOUNTING

as per lamp specifications

APPLICATION AREAS

Indoor, Commercial, Residential, Retail, Hospitality

TECHNICAL DATA

UF-L03447-D/AB

LAMP	LED
DIMMABLE	YES
BASE	E27
TOTAL POWER (W)	4W
SYSTEM OUTPUT (LM)	140LM
CCT (K)	2000K
CRI (Ra)	80
BEAM ANGLE	360°
OPERATING VOLTAGE-VAC	240V
RATED LIFE (HRS)	15 000HRS
DIMENSIONS	D:φ165 X H:265mm

SHUTTLE DIM DATA

SDIM-L-LED-125/500

TYPE	BELL PRESS DIMMER
DIMMING METHOD	LEADING OR TRAILING EDGE
MIN LOAD POWER	125W and 500W
DIMENSIONS	125W: 36 x 36 x 12mm 500W: 42 x 42 x 13mm

DIMMABLE LARGE PEAR A165 SMOKE

**DIMMABLE WONKY
LARGE PEAR A165 SMOKE**

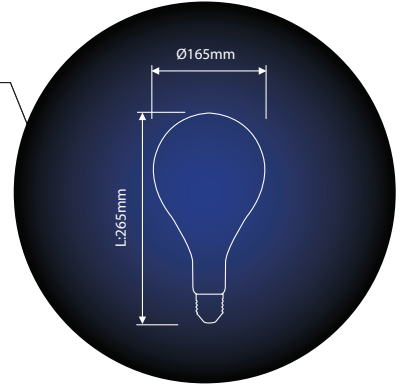

PHYSICAL DATA

FEATURES

- LED A165 wonky large pear smoke filament bulb
- Spiral filament
- Dimmable

MOUNTING

as per lamp specifications

APPLICATION AREAS

Indoor, Commercial, Residential, Retail, Hospitality

OPTIONS & ACCESSORIES

- Base available for selection: E27

+ IP 20



✓ 1 YR

TECHNICAL DATA

HX-PS165-4W/SM

LAMP	LED
DIMMABLE	YES
BASE	E27
TOTAL POWER (W)	4W
SYSTEM OUTPUT (LM)	140LM
CCT (K)	2000K
CRI (Ra)	80
BEAM ANGLE	360°
OPERATING VOLTAGE-VAC	240V
RATED LIFE (HRS)	15 000HRS
DIMENSIONS	D:φ165 X H:265mm

SHUTTLE DIM DATA

SDIM-L-LED-125/500

TYPE	BELL PRESS DIMMER
DIMMING METHOD	LEADING OR TRAILING EDGE
MIN LOAD POWER	125W and 500W
DIMENSIONS	125W: 36 x 36 x 12mm 500W: 42 x 42 x 13mm

LAMPS - DIMMABLE WONKY LARGE PEAR A165 SMOKE

FILAMENT CLEAR MINI MAXI GLOBE

CLEAR FILAMENT
MINI-MAXI GLOBE

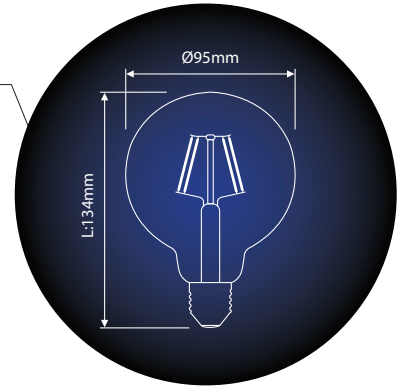

+ IP 20



2 YRS

PHYSICAL DATA

FEATURES

- Clear filament LED mini maxi globe
- Non-dimmable

OPTIONS & ACCESSORIES

- Base available for selection: B22 and E27

MOUNTING

as per lamp specifications

APPLICATION AREAS

Indoor, Commercial, Residential, Retail, Hospitality

TECHNICAL DATA

G974

G974BC

LAMP	LED	LED
DIMMABLE	NO	NO
BASE	E27	B22
TOTAL POWER (W)	4W	4W
SYSTEM OUTPUT (LM)	400LM	400LM
CCT (K)	3000K	3000K
CRI (Ra)	80	80
BEAM ANGLE	360°	360°
OPERATING VOLTAGE-VAC	230V	230V
RATED LIFE (HRS)	15 000HRS	15 000HRS
DIMENSIONS	D:φ95 X H:134mm	D:φ95 X H:134mm

AMBER FILAMENT MINI MAXI GLOBE

AMBER FILAMENT
MINI-MAXI GLOBE

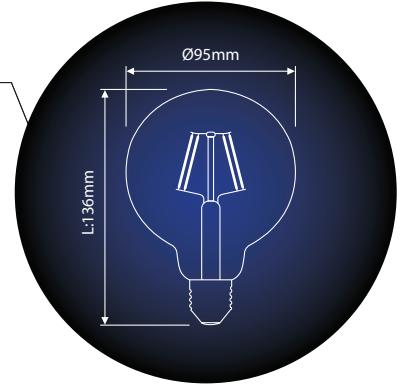

PHYSICAL DATA

+ IP 20



2 YRS

FEATURES

- Amber filament LED mini maxi globe
- Non-dimmable

OPTIONS & ACCESSORIES

- Base available for selection: B22 and E27

MOUNTING

as per lamp specifications

APPLICATION AREAS

Indoor, Commercial, Residential, Retail, Hospitality

TECHNICAL DATA

G514BC

G514ES

LAMP	LED	LED
DIMMABLE	NO	NO
BASE	B22	E27
TOTAL POWER (W)	4W	4W
SYSTEM OUTPUT (LM)	370LM	370LM
CCT (K)	2500K	2500K
CRI (Ra)	75	75
BEAM ANGLE	360°	360°
OPERATING VOLTAGE-VAC	230V	230V
RATED LIFE (HRS)	15 000HRS	15 000HRS
DIMENSIONS	D:φ95 X H:136mm	D:φ95 X H:136mm

DIMMABLE OPAL MAXI GLOBE

DIMMABLE
OPAL MAXI GLOBE

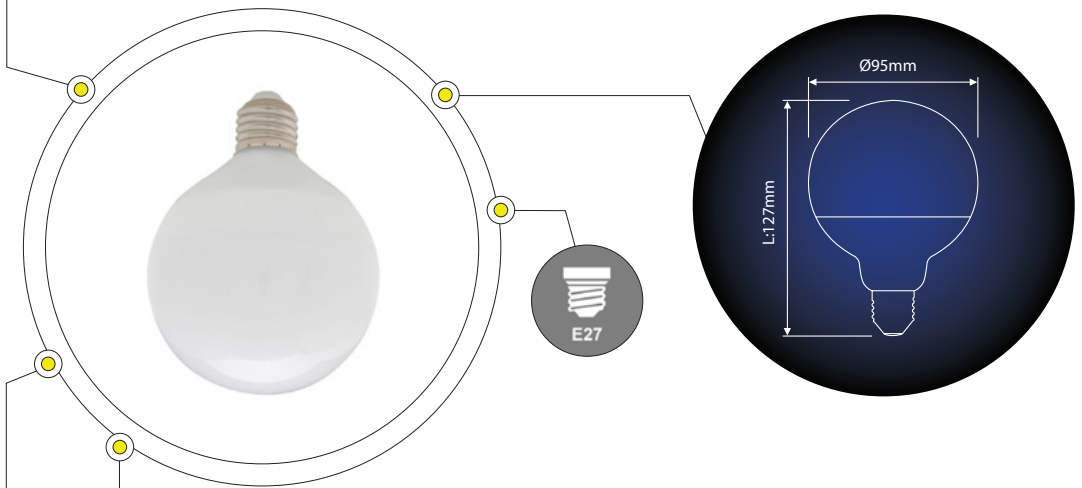

+ IP 20



2 YRS

PHYSICAL DATA

FEATURES

- LED Opal mini maxi globe
 - Dimmable
- Please ensure that the minimum load requirement of each respective dimmer is adhered to
Ensure the dimming module is compatible with the lamp

- Dimmer modules available:
LED Trailing Edge Rotary Dimmer
LED Trailing Edge Push Button Dimmer

MOUNTING

as per lamp specifications

OPTIONS & ACCESSORIES

- Base available for selection: E27

APPLICATION AREAS

Indoor, Commercial, Residential, Retail, Hospitality

TECHNICAL DATA

G990WW

LAMP	LED
DIMMABLE	YES
BASE	E27
TOTAL POWER (W)	13W
SYSTEM OUTPUT (LM)	950LM
CCT (K)	3000K
CRI (Ra)	80
BEAM ANGLE	360°
OPERATING VOLTAGE-VAC	230V
RATED LIFE (HRS)	15 000HRS
DIMENSIONS	D:φ95 X H:127mm

SHUTTLE DIM DATA

SDIM-L-LED-125/500

TYPE	BELL PRESS DIMMER
DIMMING METHOD	LEADING OR TRAILING EDGE
MIN LOAD POWER	125W and 500W
DIMENSIONS	125W: 36 x 36 x 12mm 500W: 42 x 42 x 13mm

OPAL MINI MAXI GLOBE

OPAL MINI MAXI GLOBE

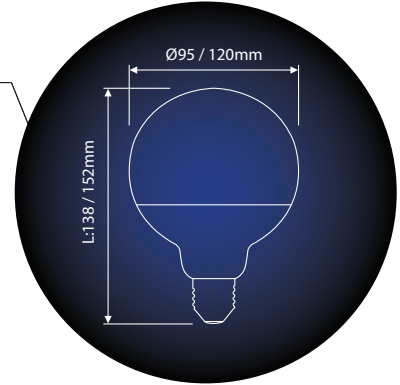

PHYSICAL DATA

+ IP 20



3 YRS

FEATURES

- Opal LED mini maxi globe
- Non-dimmable

MOUNTING

as per lamp specifications

OPTIONS & ACCESSORIES

- Base available for selection: B22 and E27

APPLICATION AREAS

Indoor, Commercial, Residential, Retail, Hospitality

TECHNICAL DATA

G24CW

G24LED

G78CW

G78WW

LAMP	LED	LED	LED	LED
DIMMABLE	NO	NO	NO	NO
BASE	E27	E27	B22	B22
TOTAL POWER (W)	15W	15W	15W	15W
SYSTEM OUTPUT (LM)	1100LM	1100LM	1100LM	1100LM
CCT (K)	4000K	3000K	4000K	3000K
CRI (Ra)	80	80	80	80
BEAM ANGLE	200°	200°	200°	200°
OPERATING VOLTAGE-VAC	230V	230V	230V	230V
RATED LIFE (HRS)	15 000HRS	15 000HRS	15 000HRS	15 000HRS
DIMENSIONS	D:φ95 x H:138mm	D:φ95 x H:138mm	D:φ95 x H:138mm	D:φ95 x H:138mm

DIMMABLE FILAMENT GOLFBALL

DIMMABLE CLEAR FILAMENT GOLFBALL

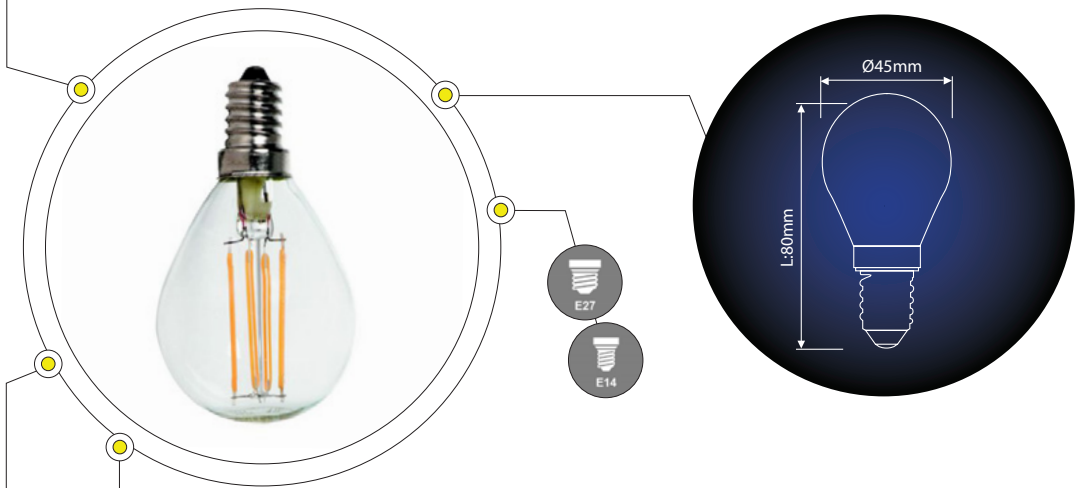

+ IP 20



✓ 1 YR

PHYSICAL DATA

FEATURES

- LED Clear filament golfball bulb
- Dimmable

OPTIONS & ACCESSORIES

- Base available for selection: E27 and E14

MOUNTING

as per lamp specifications

APPLICATION AREAS

Indoor, Commercial, Residential, Retail, Hospitality

TECHNICAL DATA

HX-GL45-4W

HX-GL45-4W/CW

HX-GB45-4W

LAMP	LED	LED	LED
DIMMABLE	YES	YES	YES
BASE	E14	E14	E27
TOTAL POWER (W)	4W	4W	4W
SYSTEM OUTPUT (LM)	340-360LM	340-360LM	340-360LM
CCT (K)	2200K	6500K	2200K
CRI (Ra)	80	80	80
BEAM ANGLE	350°	350°	350°
OPERATING VOLTAGE-VAC	240V	240V	240V
RATED LIFE (HRS)	15 000HRS	15 000HRS	15 000HRS
DIMENSIONS	D:φ45 x H:80mm	D:φ45 x H:80mm	D:φ45 x H:80mm

SHUTTLE DIM DATA

SDIM-L-LED-125/500

TYPE	BELL PRESS DIMMER
DIMMING METHOD	LEADING OR TRAILING EDGE
MIN LOAD POWER	125W and 500W
DIMENSIONS	125W: 36 x 36 x 12mm 500W: 42 x 42 x 13mm

FROSTED FILAMENT GOLFBALL

FROSTED FILAMENT
GOLFBALL

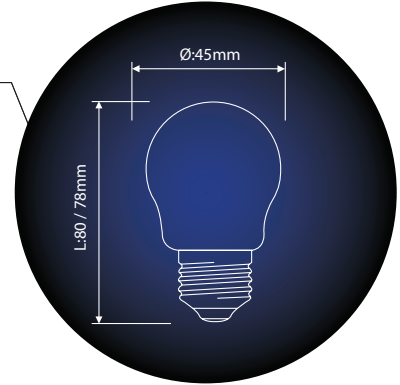

PHYSICAL DATA

FEATURES

- Frosted LED filament golfball
- Non-dimmable

OPTIONS & ACCESSORIES

- Base available for selection: B22 and E27

MOUNTING

as per lamp specifications

APPLICATION AREAS

Indoor, Commercial, Residential, Retail, Hospitality

+ IP 20



✓
2 YRS

TECHNICAL DATA

G652BP

G653BP

LAMP	LED	LED
DIMMABLE	NO	NO
BASE	E27	B22
TOTAL POWER (W)	4W	4W
SYSTEM OUTPUT (LM)	400LM	400LM
CCT (K)	3000K	3000K
CRI (Ra)	80	80
BEAM ANGLE	350°	350°
OPERATING VOLTAGE-VAC	230V	230V
RATED LIFE (HRS)	15 000HRS	15 000HRS
DIMENSIONS	D:φ45 X H:80mm	D:φ45 X H:78mm

T-LAMP

T-LAMP



+ IP 20



2 YRS

PHYSICAL DATA

FEATURES

- LED T-Lamp
- Non-dimmable

OPTIONS & ACCESSORIES

- Base available for selection: E27

MOUNTING

as per lamp specifications

APPLICATION AREAS

Indoor, Commercial, Residential, Retail, Hospitality

TECHNICAL DATA

G1043CW

G1044CW

G1045CW

G1046CW

LAMP	LED	LED	LED	LED
DIMMABLE	NO	NO	NO	NO
BASE	E27	E27	E27	E27
TOTAL POWER (W)	20W	30W	40W	50W
SYSTEM OUTPUT (LM)	1800LM	2700LM	3600LM	4500LM
CCT (K)	4000K	4000K	4000K	4000K
CRI (Ra)	80	80	80	80
BEAM ANGLE	200°	200°	200°	200°
OPERATING VOLTAGE-VAC	230V	230V	230V	230V
RATED LIFE (HRS)	25 000HRS	25 000HRS	25 000HRS	25 000HRS
DIMENSIONS	D:φ80 x H:150mm	D:φ100 x H:175mm	D:φ120 x H:205mm	D:φ140 x H:236mm

G9 BI-PIN

DIMMABLE & NON-DIMMABLE
G9 BI-PIN

LAMPS - G9 BI-PIN

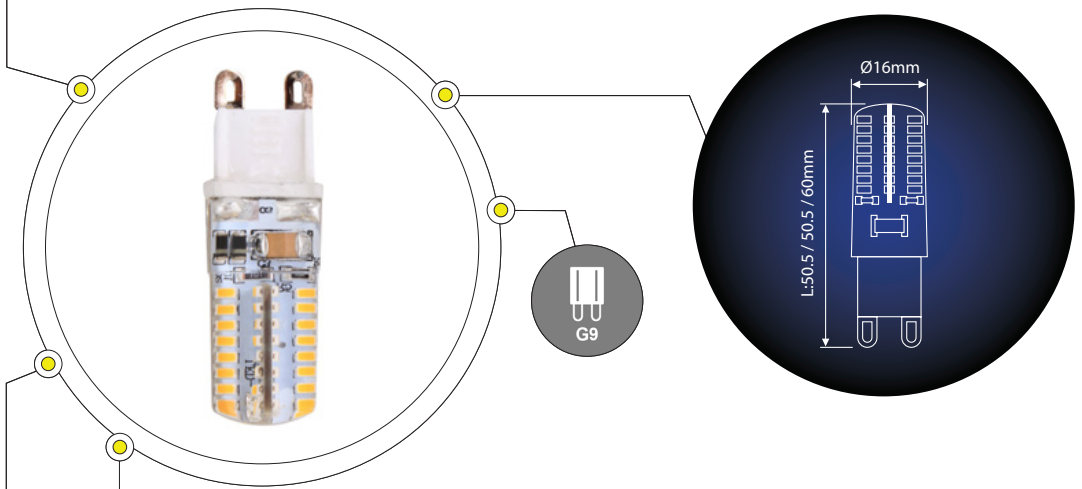

+ IP 20



2 YRS

PHYSICAL DATA

FEATURES

- LED Bi-Pin
- Non-dimmable and dimmable options for selection

LED Trailing Edge Rotary Dimmer
LED Trailing Edge Push Button Dimmer

OPTIONS & ACCESSORIES

- Base available for selection: G9
- Dimmable 4W G9 Bi-Pin LED, G991WW, available for selection
- Dimmer modules available:

MOUNTING

as per lamp specifications

APPLICATION AREAS

Indoor, Commercial, Residential, Retail, Hospitality

TECHNICAL DATA

G949WW

G949CW

G991WW

LAMP	LED	LED	LED
DIMMABLE	NO	NO	YES
BASE	G9	G9	G9
TOTAL POWER (W)	3W	3W	4W
SYSTEM OUTPUT (LM)	170LM	170LM	250LM
CCT (K)	3000K	4000K	3000K
CRI (Ra)	70	70	70
BEAM ANGLE	360°	360°	360°
OPERATING VOLTAGE-VAC	230V	230V	230V
RATED LIFE (HRS)	15 000HRS	15 000HRS	15 000HRS
DIMENSIONS	D:φ16 X H:50.5mm	D:φ16 X H:50.5mm	D:φ16 X H:60mm

SHUTTLE DIM DATA

SDIM-L-LED-125/500

TYPE	BELL PRESS DIMMER
DIMMING METHOD	LEADING OR TRAILING EDGE
MIN LOAD POWER	125W and 500W
DIMENSIONS	125W: 36 x 36 x 12mm 500W: 42 x 42 x 13mm

ECO TUBE T5 830/840(865) G5

T5 LED TUBES

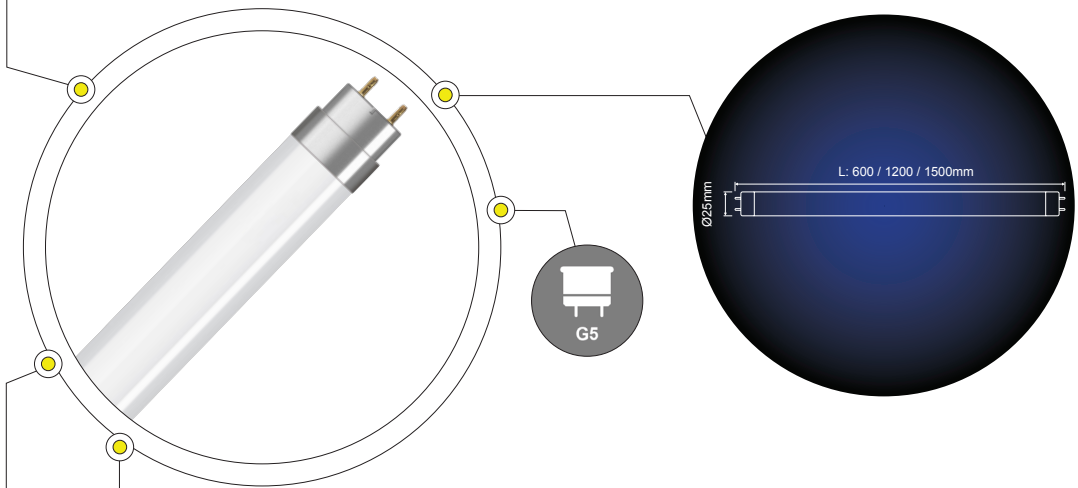

+ IP 20



✓ 1 YR

PHYSICAL DATA

FEATURES

- Quick, simple and safe replacement to fluorescent T5 without rewiring
- Excellent color fidelity for a true lighting effect (Ra≥80)
- SDCM ≤6, provides excellent light quality
- Lower maintenance cost thanks to longer lifetime than traditional Fluorescent

MOUNTING

as per lamp specifications

APPLICATION AREAS

Indoor, Commercial, Residential, Retail, Hospitality

TECHNICAL DATA

ST514E-0.6M 8W

ST528E-1.2M 16W

ST535E-1.5M 18W

ST554E-1.2M 26W

ST580E-1.5M 37W

LAMP BASE	LED G5	LED G5	LED G5	LED G5	LED G5
TOTAL POWER (W)	8W	16W	18W	26W	37W
SYSTEM OUTPUT (LM)	900LM	1800LM	2000LM	2860LM	4070LM
CCT (K)	4000 / 6500K	4000 / 6500K	4000 / 6500K	4000 / 6500K	4000 / 6500K
CRI (Ra)	80	80	80	80	80
BEAM ANGLE	160°	160°	160°	160°	160°
OPERATING VOLTAGE	220-240V	220-240V	220-240V	220-240V	220-240V
OPERATING TEMP °C	-20°C to 45°C	-20°C to 45°C	-20°C to 45°C	-20°C to 45°C	-20°C to 45°C
RATED LIFE (HRS)	15 000 HRS	15 000 HRS	15 000 HRS	15 000 HRS	15 000 HRS
POWER FACTOR	>0.5	>0.5	>0.5	>0.5	>0.5
MACADAM STEP	≤6	≤6	≤6	≤6	≤6
DIMENSIONS	D:φ25 x 600mm	D:φ25 x 1200mm	D:φ25 x 1500mm	D:φ25 x 1200mm	D:φ25 x 1500mm

ECO TUBE T8 830 (840/865) G13

T8 LED TUBES

LAMPS - T8 LED TUBES

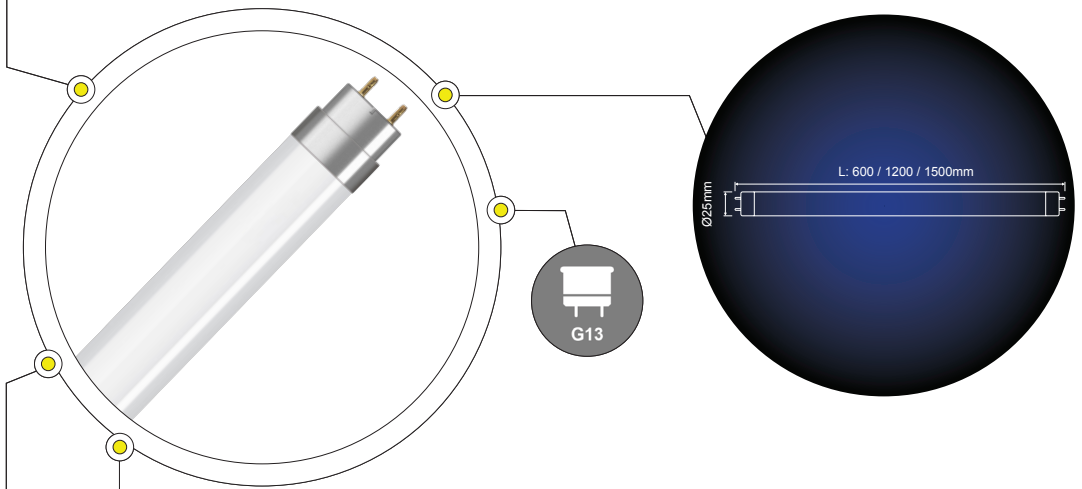

+ IP 20



✓ 1 YR

PHYSICAL DATA

FEATURES

- Quick, simple and safe replacement to fluorescent T8 without rewiring
- Excellent color fidelity for a true lighting effect (Ra≥80)
- SDCM ≤6, provides excellent light quality
- Lower maintenance cost thanks to longer lifetime than traditional Fluorescent

MOUNTING

as per lamp specifications

APPLICATION AREAS

Indoor, Commercial, Residential, Retail, Hospitality

TECHNICAL DATA

ST8E-0.6M 9W

ST8E-1.2M 18W

ST8E-1.5M 20W

	LED G13	LED G13	LED G13
LAMP BASE	G13	G13	G13
TOTAL POWER (W)	9W	18W	20W
SYSTEM OUTPUT (LM)	855 / 900 / 900LM	1710 / 1800 / 1800LM	2000LM
CCT (K)	3000 / 4000 / 6500K	3000 / 4000 / 6500K	4000 / 6500K
CRI (Ra)	80	80	80
BEAM ANGLE	160°	160°	160°
OPERATING VOLTAGE-VAC	220-240V	220-240V	220-240V
OPERATING TEMP °C	-20°C to 45°C	-20°C to 45°C	-20°C to 45°C
RATED LIFE (HRS)	15 000 HRS	15 000 HRS	15 000 HRS
POWER FACTOR	>0.5	>0.5	>0.5
MACADAM STEP	≤6	≤6	≤6
DIMENSIONS	D:φ25 x 600mm	D:φ25 x 1200mm	D:φ25 x 1500mm

> OTHER ACCESSORIES



OSRAM 1-10V DIMMER

DIMMERS

OTHER - ACCESSORIES - OSRAM 1-10V DIMMER

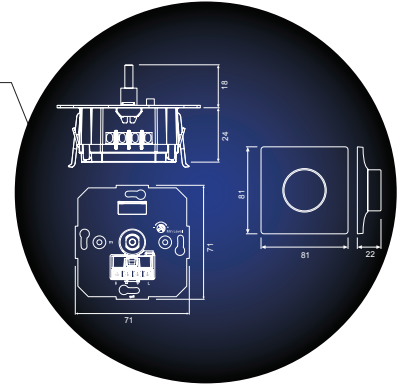
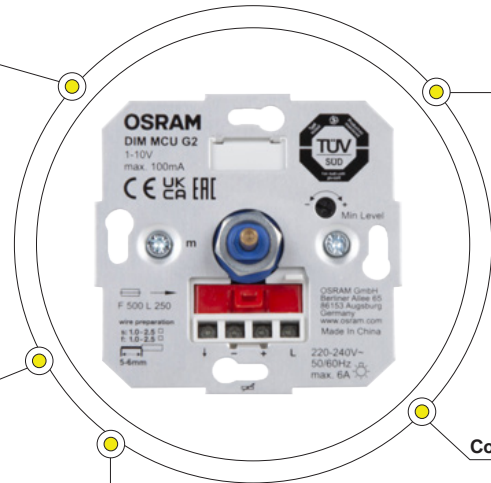

Colour:  White

Cut Out ϕ 60mm



-  + IP 20
- 
-  1 YR

PHYSICAL DATA

FEATURES

- The DIM MCU G2 control unit enables the brightness of up to 100 luminaires with a 1-10V interface to be set manually
- Intuitive manual dimming and switching
- Individual setting of minimal brightness level
- Suitable for up to 50 electronic control gears (external load contact required)
- Flexible expansion via external load contact and via signal amplifier DIM SA

- Over-current protection
- Cover and rotary knob in cream white

MOUNTING
Recessed

APPLICATION AREAS
Indoor, Commercial, Residential, Retail, Hospitality

TECHNICAL DATA

DIM MCU G2

TYPE	ROTARY KNOB
DIMMING METHOD	1-10V
OUTPUT CONTROLS	1
LOAD CONTACT	6A
MAX INRUSH CURRENT	≤100A
CONTROL OUTPUT LOAD	
CAPACITY	max 100MA
OVER-CURRENT PROTECTION	FUSE ¹⁰ (F500 L250)
OPERATING VOLTAGE - VAC	230V
OPERATING TEMP °C	-20°C to 50°C
WEIGHT (KG)	0.88KG
COVER DIMENSIONS	L:81 x H:81 x W:22mm
DIMENSIONS	L:71 x H:71 x W:42mm
CUT OUT	D:φ60mm

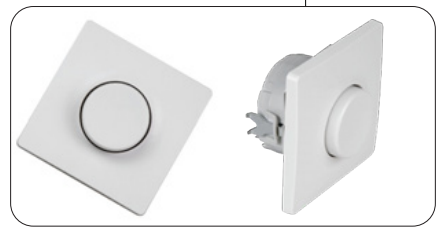
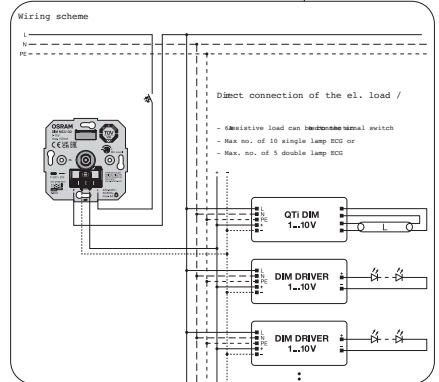

E&OE MAY OCCUR

SHUTTLE DIMMER

DIMMERS

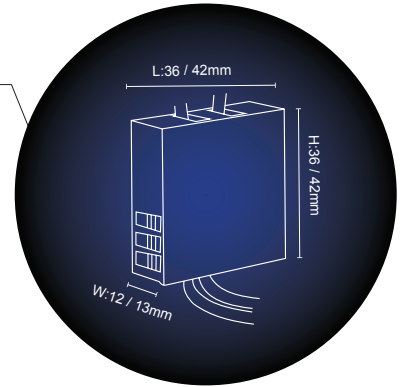
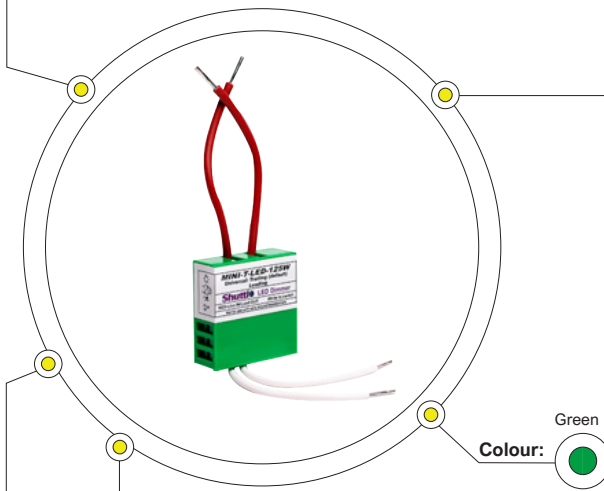

+ IP 20



✓ 1 YR

PHYSICAL DATA

FEATURES

- Material: 125W-Plastic, 500W-Aluminium
- Shuttle universal bell press dimmers are separately switched, compact, modular dimming mechanisms rated at 125W, 250W, 500W and 800W
- Designed for universal load compatibility that utilise powerful and sophisticated dimming technology to provide full control of almost any type of load
- Over-current, over-temperature, short-circuit and surge protection

- Dimming is to the lowest point
- Suitable for one-way or two-way operation
- Minimum load is one lamp
- No flickering RC-driver compatible for LED's that do not turn off completely

MOUNTING: Recessed

APPLICATION AREAS

Indoor, Commercial, Residential, Retail, Hospitality

TECHNICAL DATA

SDIM-L-LED-125/500

TYPE	BELL PRESS DIMMER
DIMMING METHOD	LEADING OR TRAILING EDGE
MAX WIRE RESISTANCE	10KΩ
MIN LOAD POWER	125W and 500W
- RESISTIVE, LED, ELECTRONIC TRANSFORMER	
- INDUCTIVE	2W
MAX LOAD POWER	10W
- RESISTIVE	125W
- ELECTRONIC TRANSFORMER	125VA
MAX LOAD POWER	0.55A rms
- RESISTIVE	500W
- ELECTRONIC TRANSFORMER	500VA
	2.1A rms
OPERATING VOLTAGE - VAC	190-253V, 50HZ ± 5%
MIN OPERATING VOLTAGE	100VAC
OPERATING TEMP °C	-5°C to +45°C
RELATIVE HUMIDITY	90% non-condensing
RETAIN MEMORY	YES
BROWN-OUT PROTECTION	YES
TRANSIENT PROTECTION	YES
SURGE PROTECTION	YES
MICROPROCESSOR CONTROL	YES
SOFT START/OFF	YES
BELL-PRESS CONTROL	CONTINUOUS CYCLING
MIN INTENSITY CONTROL	YES
DIMENSIONS	125W: 36 x 36 x 12mm 500W: 42 x 42 x 13mm

WIRING DIAGRAM

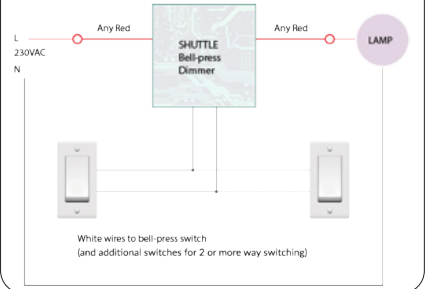

E&OE MAY OCCUR

ACCESSORIES

INLINE CONNECTORS

OTHER - ACCESSORIES - IN-LINE CONNECTORS

*In-line
Connectors*



3 POLE PLUG

CODE: 770-213



5 POLE PLUG

CODE: 770-1115



3 POLE SOCKET

CODE: 770-203



5 POLE SOCKET

CODE: 770-1105



3 POLE STRAIN-RELIEF HOUSING

CODE: 770-503



5 POLE STRAIN-RELIEF HOUSING

CODE: 770-505

> SENSORS

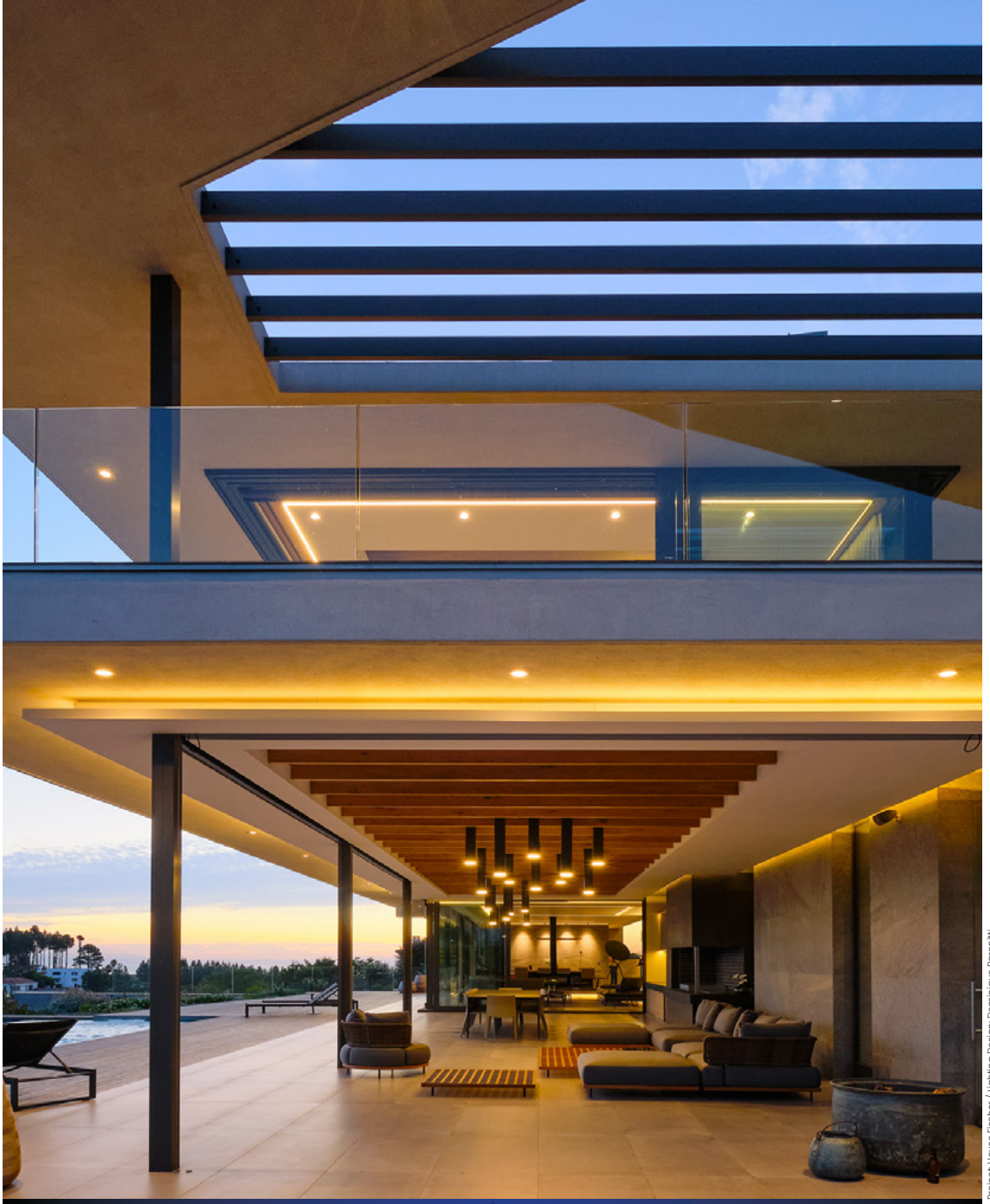

PHOTOCELL DAY / NIGHT SENSORS

SENSORS



DAY/NIGHT SWITCH 10AMP OUTDOOR RED

MODEL	RE355
TYPE	SWITCH
MATERIAL	PLASTIC PVC
IP RATING	44
OPERATING VOLTAGE	220-240V
COLOURS	WHITE & RED
WARRANTY	1 YR
DIMENSIONS	D:Ø58 x H:135mm



DAY/NIGHT OUTDOOR SWITCH 20AMP BLUE

MODEL	RE357
TYPE	SWITCH
SENSOR	AMBIENT LIGHT 2 - 100LUX
MATERIAL	PLASTIC PVC
IP RATING	44
OPERATING VOLTAGE	220-240V
COLOURS	WHITE & BLUE
WARRANTY	1 YR
DIMENSIONS	D:Ø58 x H:135mm



DAY/NIGHT SWITCH 6AMP MODULE 10MM NECK

MODEL	RE354
TYPE	SWITCH / SENSOR
MATERIAL	PLASTIC PVC
IP RATING	44
OPERATING VOLTAGE	220-240V
COLOURS	BLACK
WARRANTY	1 YR

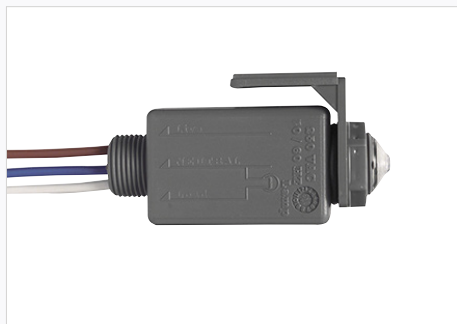

**DAY/NIGHT SWITCH 16ANA535
MODULE 20MM NECK**

MODEL	RE353
TYPE	SWITCH / SENSOR
MATERIAL	PLASTIC PVC
IP RATING	44
OPERATING VOLTAGE	220-240V
COLOURS	GREY
WARRANTY	1 YR
CUT OUT	20mm

E&OE MAY OCCUR

OTHER - SENSORS - PHOTOCCELL DAY / NIGHT SENSORS

TWILIGHT PHOTOCELL SWITCH

SENSORS

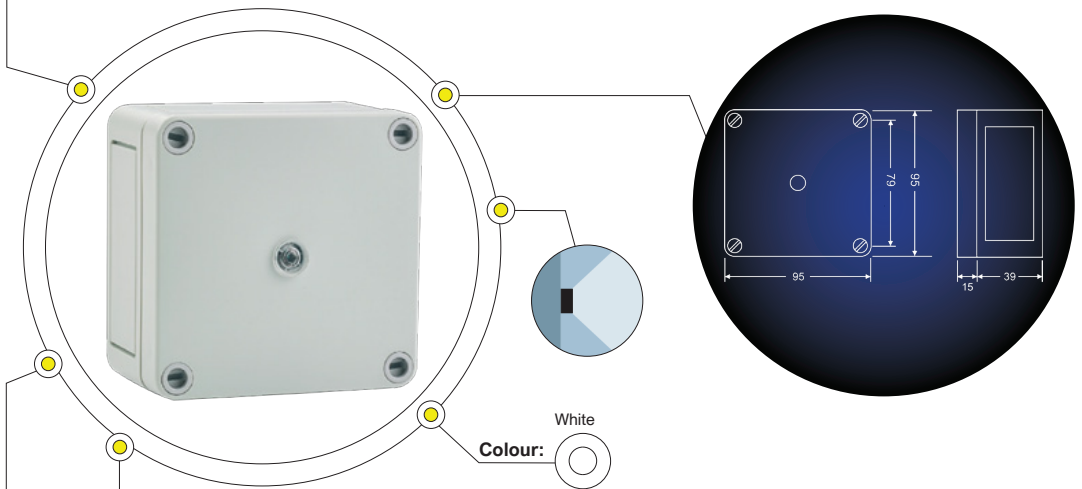

+ IP 66



5 YRS

PHYSICAL DATA

FEATURES

- Material: Polystyrene casing
- The ALC15 twilight switch will turn lighting on when the ambient light falls below a preset level
- The lighting will then be turned off when the light exceeds the preset level or after a preset time delay
 - For example, they can be used to switch external security lights at night or to turn on display or sign lighting
- The unit has a highly accurate adjustable photocell; a

- selectable time delay; adjustable switching differential and is mounted in a vandal resistant IP66 enclosure
- Works with any type of lamp
- Adjust time delay and lux settings via pots

MOUNTING: Surface

APPLICATION AREAS

Indoor, Outdoor, Commercial, Residential, Retail, Hospitality

TECHNICAL DATA

ALC15

SUPPLY VOLTAGE AC	230VAC +/- 10%
SUPPLY FREQUENCY (HZ)	50HZ
POWER CONSUMPTION	
- TERMINAL CAPACITY	2.5mm ²
OPERATING TEMP °C	-10°C TO 35°C
MAX LOADS	
- INCANDESCENT (INC)	8A
- FLUORESCENT (F)	6A
- COMPACT FLUORESCENT (CF)	3A
- LED LIGHTING	3A
- RESISTIVE HEATERS	10A
LIGHT LEVEL	ADJ 10LUX to 1000LUX
TIME-OUT RANGE	0s - 16h
WEIGHT (KG)	0.12KG
DIMENSIONS	L:95 x W:54 x H:95mm

INFRA-RED OCCUPANCY SENSOR

SENSORS

OTHER - SENSORS - CD_IR-MS

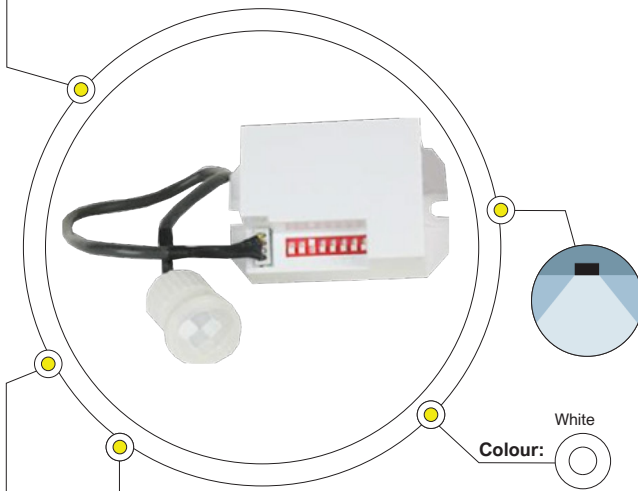

+ IP 20



2 YRS

PHYSICAL DATA

FEATURES

- The CD_IR-MS is an active, recessed infra-red motion detector
- It senses changes in heat via its Fresnel lens to detect human movement. The sensor can detect even the slightest movement in the detection zone
- 360° Sensing is assured via its heat sensors
- An 8-minute maximum time setting will reduce the possibility of the lights being extinguished when

- somebody is present
- The sensitivity as well as the ambient light and time delay settings can be adjusted according to the desired operation

MOUNTING: Surface

APPLICATION AREAS

Indoor, Commercial, Residential, Retail, Hospitality

TECHNICAL DATA

CD_IR-MS

LAMP	LED
OPERATING VOLTAGE VAC	230VAC +/- 10% 50HZ
TIME DELAY MINIMUM	5 SECONDS (min setting)
TIME DELAY MAXIMUM	8 MINUTES (max setting)
RATE LOADED	
- INCANDESCENT LAMP	800W
- ENERGY SAVING LAMP	200W
DETECTION DISTANCE	6m
DETECTION RANGE	360°
MAX AMBIENT TEMP °C	+70°C
INSTALLATION HEIGHT	2.2m - 4m
POWER CONSUMPTION	
- WORK	0.45W
- STATIC	0.1W
DETECTION SPEED	0.6 - 1.5ms

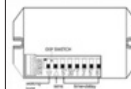

Dip Switch Settings

- > Select operation (working light) - Night only (on position)
- 24hrs (off position)
- > Select desired sensitivity: either high (on position)
low (off position)
- > Select desired time duration: 5 seconds / 30 seconds / 1 minute
3 minutes / 5 minutes / 8 minutes

HIGH BAY / HIGH LEVEL

SENSORS

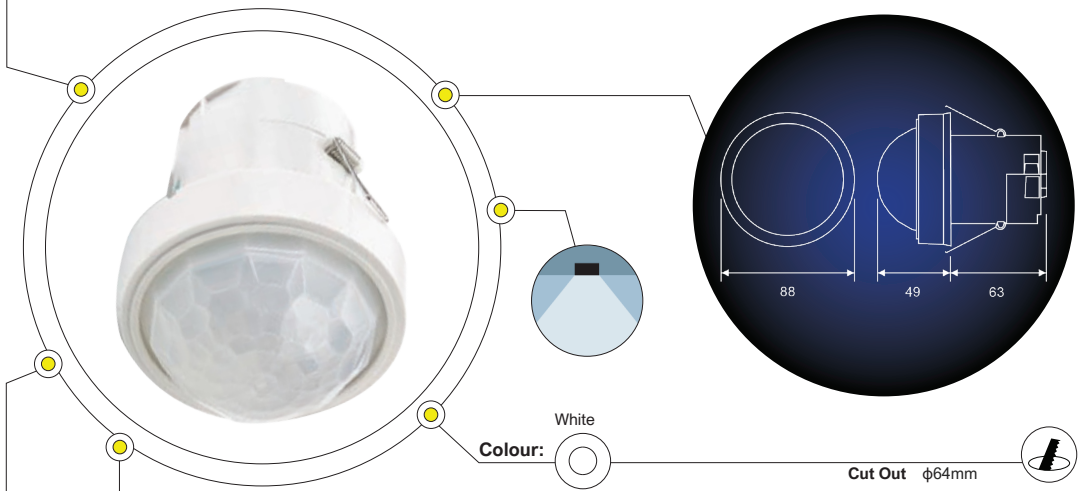

+ IP 40



5 YRS

PHYSICAL DATA

FEATURES

- Material: Flame-retardant ABS/Polycarbonate
- The EBDHS PIR presence/absence detector is developed for lighting control in areas with demanding spaces and increased mounting heights
- Ground breaking detection range - For mounting at heights up to 20m depending on operating parameters
- Unique lens technology - high sensitivity
- Ideal for high level/high bay applications
- Program time delay and lux settings via infrared handset
- Supplied with adjustable masking shields to tailor detection zones

OPTIONS & ACCESSORIES

- Available control methods include: PRM Switching, DALI & DSI Dimming, Analogue Dimming and KNX
- Special order variants for: LT30 - Low temperature and LV - Low Voltage

MOUNTING: Recessed

APPLICATION AREAS: Indoor, Commercial, Residential, Retail, Hospitality

TECHNICAL DATA

EBDHS-PRM

EBDHS-DD

EBDHS-AD

CONTROL METHOD	PRM SWITCHING	DALI / DSI DIMMING	1-10V ANALOGUE																			
DEVICE / BALLAST CONTROL	n/a	upto 20 drivers / ballasts	upto 10 drivers / ballasts																			
SUPPLY VOLTAGE AC	230VAC +/- 10%	230VAC +/- 10%	230VAC +/- 10%																			
SUPPLY FREQUENCY (HZ)	50HZ	n/a	50HZ																			
POWER CONSUMPTION																						
- PARASITIC MW	847mW	299mW	305mW																			
- TERMINAL CAPACITY	2.5mm ²	2.5mm ²	2.5mm ²																			
OPERATING TEMP °C	-10°C TO 35°C	-10°C TO 35°C	-10°C TO 35°C																			
HUMIDITY	5-95% non condensing	5-95% non condensing	5-95% non condensing																			
MAX LOADS																						
- INCANDESCENT (INC)	10A	10A	10A																			
- FLUORESCENT (F)	10A	10A	10A																			
- COMPACT FLUORESCENT (CF)	10A	10A	10A																			
- LED (LED)	10A	10A	10A																			
- RESISTIVE HEATERS (RH)	10A	10A </tr <tr> <td>- FANS & VENTILATION (F&V)</td> <td>10A</td> <td>10A</td> <td>10A</td> </tr> <tr> <td>TIME-OUT RANGE</td> <td>10s - 99m</td> <td>10s - 99m</td> <td>10s - 99m</td> </tr> <tr> <td>WEIGHT (KG)</td> <td>0.2KG</td> <td>0.2KG</td> <td>0.2KG</td> </tr> <tr> <td>DIMENSIONS</td> <td>D:φ88 x H:112mm</td> <td>D:φ88 x H:112mm</td> <td>D:φ88 x H:112mm</td> </tr> <tr> <td>CUT-OUT</td> <td>D:φ64mm</td> <td>D:φ64mm</td> <td>D:φ64mm</td> </tr>	- FANS & VENTILATION (F&V)	10A	10A	10A	TIME-OUT RANGE	10s - 99m	10s - 99m	10s - 99m	WEIGHT (KG)	0.2KG	0.2KG	0.2KG	DIMENSIONS	D:φ88 x H:112mm	D:φ88 x H:112mm	D:φ88 x H:112mm	CUT-OUT	D:φ64mm	D:φ64mm	D:φ64mm
- FANS & VENTILATION (F&V)	10A	10A	10A																			
TIME-OUT RANGE	10s - 99m	10s - 99m	10s - 99m																			
WEIGHT (KG)	0.2KG	0.2KG	0.2KG																			
DIMENSIONS	D:φ88 x H:112mm	D:φ88 x H:112mm	D:φ88 x H:112mm																			
CUT-OUT	D:φ64mm	D:φ64mm	D:φ64mm																			

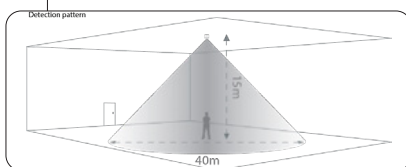

COMPACT SURFACE MOUNT

SENSORS

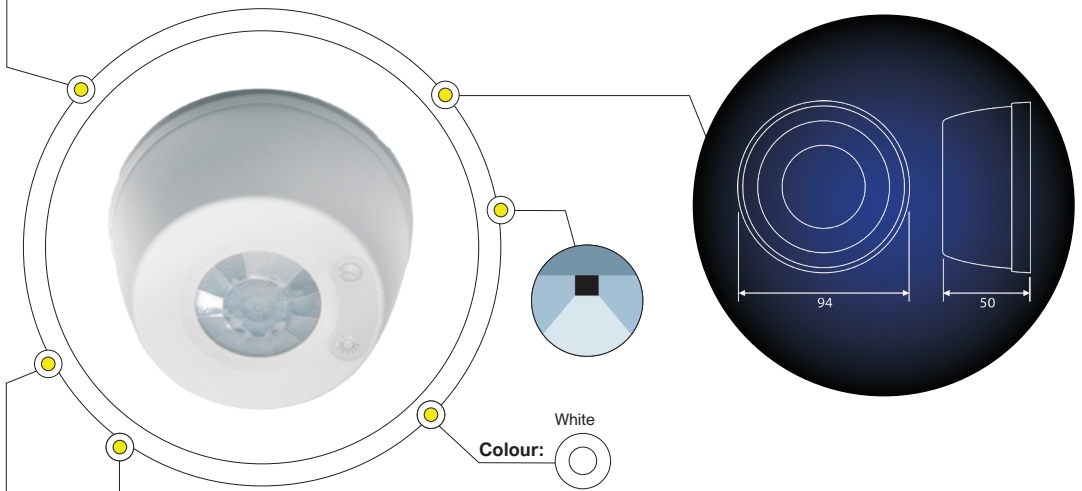

PHYSICAL DATA

FEATURES

- Material: Flame retardant ABS and Polycarbonate/ABS
- These compact surface mounted, self-contained PIR detectors provide automatic control for lighting, heating and ventilation loads
- This range of surface mounted PIR presence detectors is perfect for simple attachment when flush mounting is not possible
- Infrared programmable via our UHS5 and UNLCDHS handsets
- IP40 without gasket; IP54 with gasket

OPTIONS & ACCESSORIES

- Three models are available: premium (PRM), direct dim (DD), and analogue dim (AD) all of which will switch a wide range of luminaires. The direct dim variant controls DALI or DSI digital dimming ballasts whilst the analogue dim variant controls 1-10V dimming ballasts
- UHS5 and UNLCDHS handsets available for selection

MOUNTING: Surface

APPLICATION AREAS: Indoor, Commercial, Residential, Retail, Hospitality

+ IP 54



5 YRS

TECHNICAL DATA

EBDSM-PRM

EBDSM-DD

EBDSM-AD

CONTROL METHOD	PRM SWITCHING	DALI / DSI DIMMING	1-10V ANALOGUE
DEVICE/BALLAST CONTROL	-	upto 20 DRIVERS/BALLASTS	upto 10 DRIVERS/BALLASTS
SUPPLY VOLTAGE AC	230VAC +/- 10%	230VAC +/- 10%	230VAC +/- 10%
SUPPLY FREQUENCY (HZ)	50HZ	n/a	n/a
POWER CONSUMPTION			
- PARASITIC MW	895mW	807mW	260mW
- TERMINAL CAPACITY	2.5mm ²	2.5mm ²	2.5mm ²
OPERATING TEMP °C	-10°C TO 35°C	-10°C TO 35°C	-10°C TO 35°C
HUMIDITY	5-95% non condensing	5-95% non condensing	5-95% non condensing
MAX LOADS			
- INCANDESCENT (INC)	10A	10A	10A
- FLUORESCENT (F)	10A	10A	10A
- COMPACT FLUORESCENT (CF)	10A	10A	10A
- LED LIGHTING	10A	10A	10A
- RESISTIVE HEATERS	10A	10A	10A
- FANS/VENTILATION EQUIP	10A	10A	10A
TIME-OUT RANGE	10s - 99m	10s - 99m	10s - 99m
WEIGHT (KG)	0.15KG	0.15KG	0.15KG
DIMENSIONS	D:φ94 x H:50mm	D:φ94 x H:50mm	D:φ94 x H:50mm

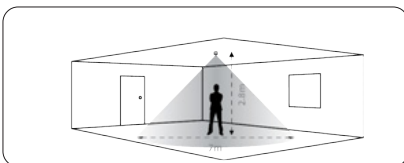

E&OE MAY OCCUR

COMPACT FLUSH MOUNT PIR

SENSORS

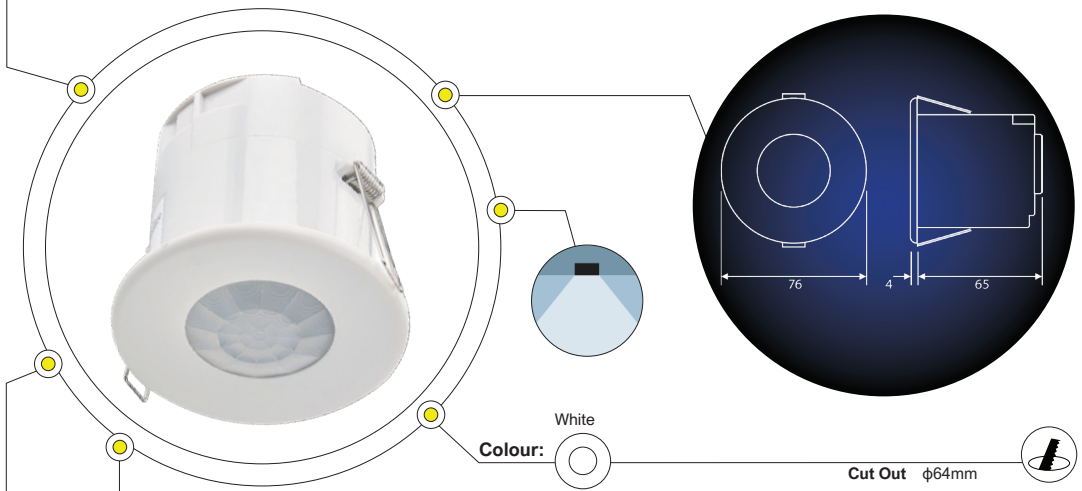

+ IP 54



5 YRS

PHYSICAL DATA

FEATURES

- Material: Flame retardant ABS and Polycarbonate/ABS casing
- This self-contained, pluggable, compact PIR detectors provide automatic control for lighting, heating and ventilation loads
- The PIR sensor can be mounted either flush into a ceiling tile or using a surface mounting box and can be mounted in a narrow ceiling void

OPTIONS & ACCESSORIES

- Available control methods: PRM Switching, DALI / DSI

Dimming, Analogue Dimming and KNX

- PRM, DD and AD versions functionality is fully programmable using either the UHS5 or UNLCDHS handsets
- Available options include: 2CH, 2CH LV, LT30, VFC, VFC NC, LV, VFC LV and VFC LV NC

MOUNTING

Recessed or Surface (with surface mounting box)

APPLICATION AREAS: Indoor, Commercial, Residential, Retail, Hospitality

TECHNICAL DATA

EBDSPIR

CONTROL METHOD	1-10V ANALOGUE
DEVICE / BALLAST CONTROL	upto 10
SUPPLY VOLTAGE AC	230VAC +/- 10%
SUPPLY FREQUENCY (HZ)	50HZ
POWER CONSUMPTION	
- PARASITIC MW	260mW
- TERMINAL CAPACITY	2.5mm ²
OPERATING TEMP °C	-10°C TO 35°C
HUMIDITY	5-95% non condensing
MAX LOADS	
- INCANDESCENT (INC)	10A
- FLUORESCENT (F)	10A
- COMPACT FLUORESCENT (CF)	10A
- LED LIGHTING	10A
- RESISTIVE HEATERS (RH)	10A
TIME-OUT RANGE	10s - 99m
WEIGHT (KG)	0.150KG
DIMENSIONS	D:φ76 x H:69mm
CUT OUT	D:φ64mm

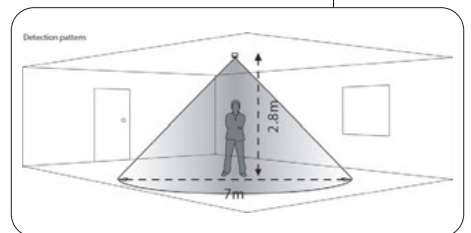

E&OE MAY OCCUR

MINI RETROFIT LUMINAIRE MOUNTED

SENSORS

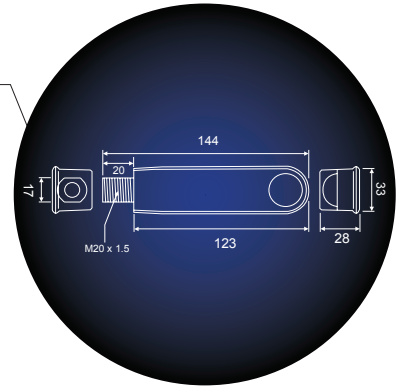
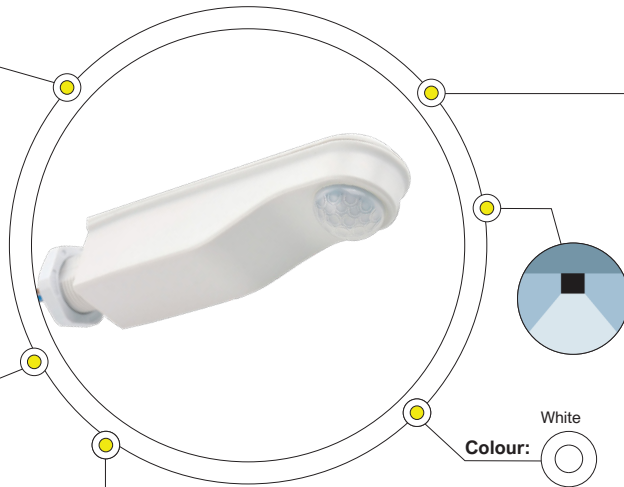

White
Colour:

+ IP 65



5 YRS

PHYSICAL DATA

FEATURES

- Material: Flame retardant ABS/Polycarbonate
- The EBMPIR-MB series of batten mount PIR presence detectors provide automatic control of lighting loads
- Batten mount retrofit system, movement detection up to 9metres high
- Three models are available: premium (PRM), direct dim (DD) and analogue dim (AD) all of which will switch a wide range of luminaires
- The direct dim variant controls DALI or DSI digital dimming ballasts, whilst the analogue dim variant controls 1-10V dimming ballasts

OPTIONS & ACCESSORIES

- Available control methods: PRM Switching, DALI / DSI Dimming, 1-10V Analogue Dimming
- Available options: LT30 - low temperature and LV - low voltage
- Functionality is fully programmable using either the UHS5 or UNLCDHS handsets

MOUNTING: Surface, retrofit to luminaire

APPLICATION AREAS: Indoor, Outdoor, Commercial, Residential, Retail, Hospitality

TECHNICAL DATA

EBMPIR-MB-AD

EBMPIR-MB-DD

EBMPIR-MB-PRM

CONTROL METHOD	1-10V ANALOGUE	DALI / DSI DIMMING	PRM SWITCHING
SUPPLY VOLTAGE AC	230VAC +/- 10%	230VAC +/- 10%	230VAC +/- 10%
SUPPLY FREQUENCY (HZ)	50HZ	n/a	n/a
POWER CONSUMPTION - PARASITIC MW	817mW	516mW	807mW
OPERATING TEMP °C	-10°C TO 50°C	-10°C TO 50°C	-10°C TO 50°C
HUMIDITY	5-95% non condensing	5-95% non condensing	5-95% non condensing
MAX LOADS			
- INCANDESCENT (INC)	2A	n/a	2A
- FLUORESCENT (F)	2A	n/a	2A
- COMPACT FLUORESCENT (CF)	2A	n/a	2A
- LED LIGHTING	2A	n/a	2A
TIME-OUT RANGE	10s - 99m	10s - 99m	10s - 99m
WEIGHT (KG)	0.1KG	0.1KG	0.1KG
DIMENSIONS	L:144 x W:28 x H:33mm	L:144 x W:28 x H:33mm	L:144 x W:28 x H:33mm

Detection pattern

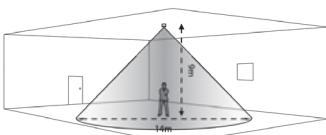

E&OE MAY OCCUR

LOW PROFILE FLUSH MOUNT

SENSORS

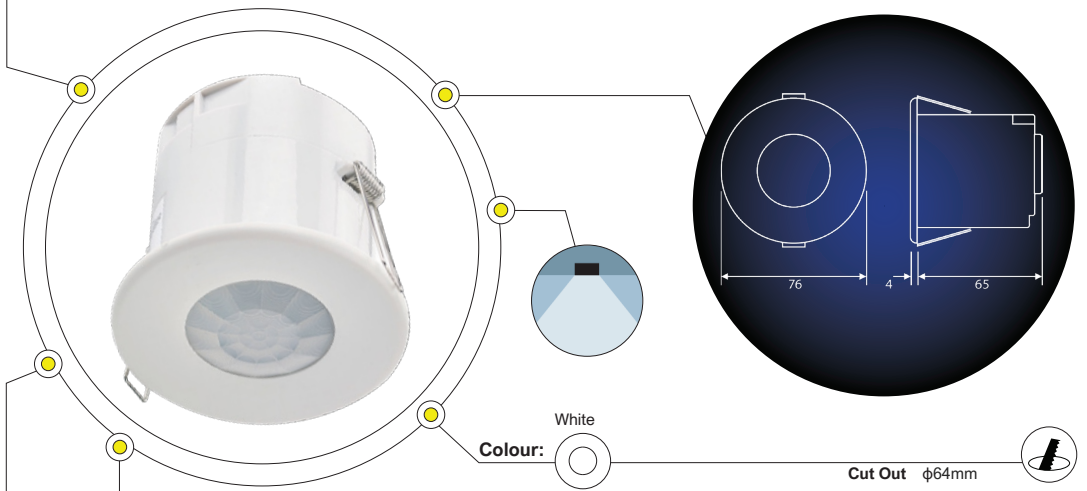

+ IP 55



5 YRS

PHYSICAL DATA

FEATURES

- Material: Flame retardant ABS
- A low profile, flush mounted presence detector that is easy to set up via an infrared handset (GEFL-HS – sold separately), that provides auto on/auto off switching
- GEFL offers presence detection and Lux level sensing
- Adjustable via IR handset, adjustable lux and timer
- Switches any type of load, works with any type of lamp
- Integral power supply

OPTIONS & ACCESSORIES

- Sensor options include: GEFL-PB push button and GEFL-IR Infra-red for selection
- GEFL-HS, Infrared handset, available for sensor setup

MOUNTING: Recessed

APPLICATION AREA: Indoor, Commercial, Residential, Retail, Hospitality

TECHNICAL DATA

GEFL

CONTROL METHOD	SENSING CONTROL
SUPPLY VOLTAGE AC	230VAC +/- 10%
SUPPLY FREQUENCY (HZ)	50HZ
POWER CONSUMPTION	
- TERMINAL CAPACITY	2.5mm ²
OPERATING TEMP °C	-10°C TO 35°C
HUMIDITY	5-95% non condensing
MAX LOADS	
- INCANDESCENT (INC)	8A
- FLUORESCENT (F)	4A
- COMPACT FLUORESCENT (CF)	3A
- LED LIGHTING	3A
- RESISTIVE HEATERS (RH)	8A
TIME-OUT RANGE	10s - 30m
WEIGHT (KG)	0.150KG
DIMENSIONS	D:φ76 x H:69mm
CUT OUT	D:φ64mm



Detection pattern

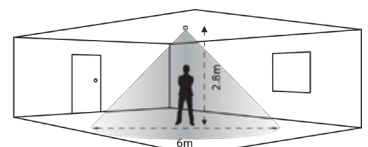

E&OE MAY OCCUR

SURFACE PIR MOVEMENT SENSOR

SENSORS

OTHER – SENSORS – GESM

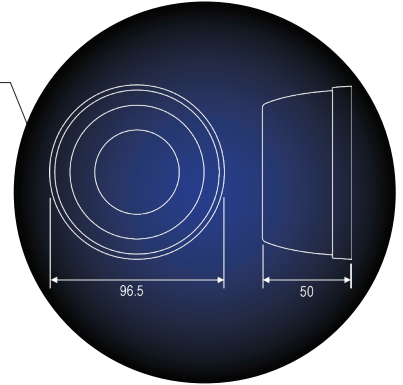
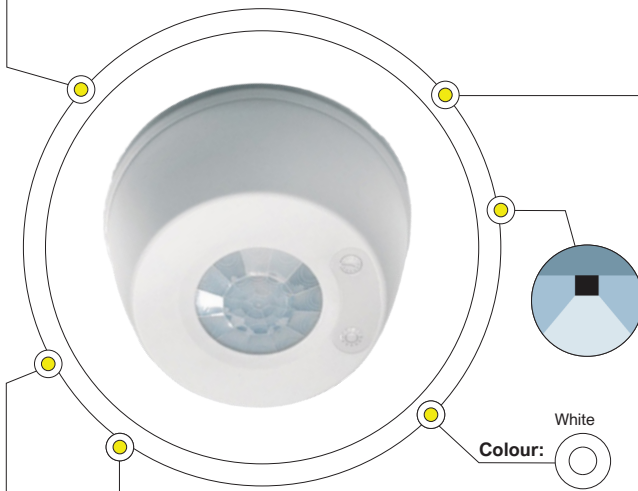

White
Colour:

+ IP 54



5 YRS

PHYSICAL DATA

FEATURES

- Material: Flame retardant ABS and Polycarbonate/ABS
- The GESM movement sensor provides automatic control of lighting, heating or ventilation loads
- An adjustable internal light sensor provides additional energy saving in lighting applications. When the sensor is first powered up the PIR sensor will always detect immediately regardless of whether the room is occupied

- PIR Sensor, Light-level Sensor, LED feedback, LUX Level Switching, Adjustable Timer Button
- Knock outs for wiring, lockable settings, integral power supply

MOUNTING: Surface

APPLICATION AREA: Indoor, Commercial, Residential, Retail, Hospitality

TECHNICAL DATA

GESM

SUPPLY VOLTAGE AC	230VAC +/- 10%
SUPPLY FREQUENCY (HZ)	50HZ
CIRCUIT PROTECTION	10A
POWER CONSUMPTION	
- ON	572mW
- OFF	670mW
- TERMINAL CAPACITY	2.5mm ²
OPERATING TEMP °C	-10°C TO 35°C
HUMIDITY	5-95% non condensing
MAX LOADS	
- RESISTIVE	10A
- INCANDESCENT (INC)	10A
- FLUORESCENT (F)	6A
- COMPACT FLUORESCENT (CF)	3A
- LOW ENERGY LIGHTING	3A
- LED LIGHTING	3A
- FANS/VENTILATION	3A
TIME-OUT RANGE	10s - 30m
WEIGHT (KG)	0.150KG
DIMENSIONS	D:φ96.5 x H:50mm

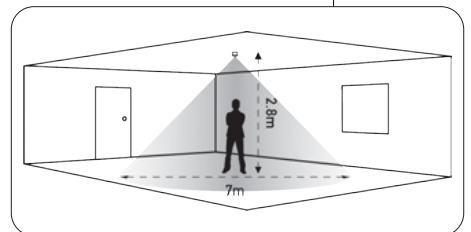

E&OE MAY OCCUR

ADJ MICROWAVE DETECTORS

SENSORS

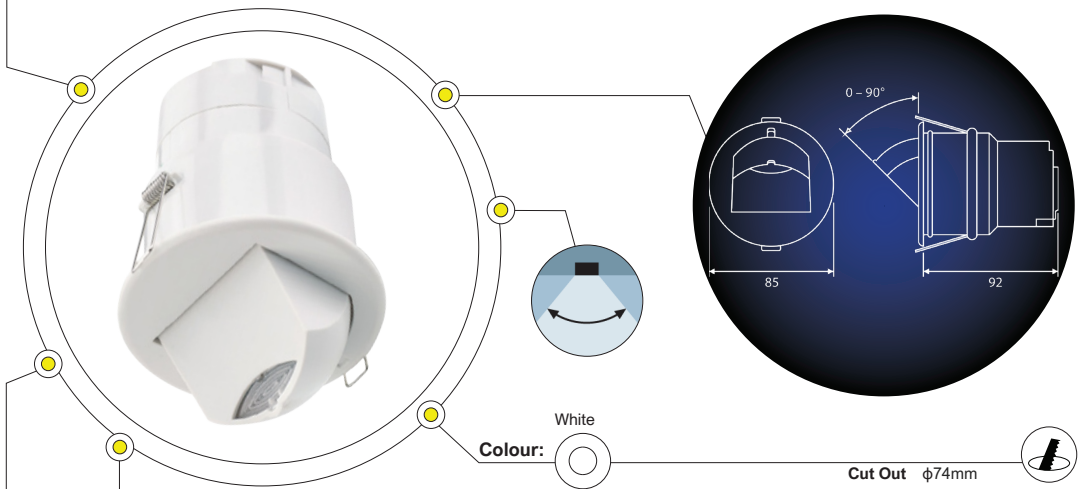

+ IP 40



5 YRS



PHYSICAL DATA

FEATURES

- Material: Flame retardant ABS/Polycarbonate
- The MWS3A has a unique presence/absence detection capability by using an adjustable head; by changing the angle of the head, different detection patterns can be achieved to suit the application
- Innovative locking mechanism to prevent tampering
- The microwave presence detector is self contained and can be flush or surface mounted using a separate detector back box
- The optional infrared remote handset allows the user to override the set up on some models

OPTIONS & ACCESSORIES

- Available control methods: PRM Switching, DALI / DSI Dimming, 1-10V Analogue Dimming and KNX
- Functionality is fully programmable using either the UHS5 or UNLCDHS handsets
- Available options: LV, VFC, VFC NC, 2CH, 2CH NC - 2

MOUNTING: Recessed or Surface (with detector box)

APPLICATION AREAS: Indoor, Commercial, Residential, Retail, Hospitality

TECHNICAL DATA

MWS3A-PRM

MWS3A-DD

MWS3A-AD

CONTROL METHOD	PRM SWITCHING	DALI / DSI DIMMING	1-10V ANALOGUE
DEVICE/BALLAST CONTROL	n/a	upto 20 DRIVERS/BALLASTS	upto 10 DRIVERS/BALLASTS
SUPPLY VOLTAGE AC	230VAC +/- 10%	230VAC +/- 10%	230VAC +/- 10%
SUPPLY FREQUENCY (HZ)	n/a	n/a	50HZ
POWER CONSUMPTION			
- PARASITIC MW	910mW	961mW	959mW
- TERMINAL CAPACITY	2.5mm ²	2.5mm ²	2.5mm ²
OPERATING TEMP °C	-10°C TO 50°C	-10°C TO 50°C	-10°C TO 50°C
HUMIDITY	5-95% non condensing	5-95% non condensing	5-95% non condensing
MAX LOADS			
- INCANDESCENT (INC)	10A	10A	10A
- FLUORESCENT (F)	10A	10A	10A
- COMPACT FLUORESCENT (CF)	10A	10A	10A
- LED LIGHTING	10A	10A	10A
- RESISTIVE HEATERS	10A	10A	10A
- FANS/VENTILATION EQUIP	10A	10A	10A
TIME-OUT RANGE	10s - 99m	10s - 99m	10s - 99m
WEIGHT (KG)	0.15KG	0.15KG	0.15KG
DIMENSIONS	D:φ85 x H:92mm	D:φ85 x H:92mm	D:φ85 x H:92mm
CUT OUT	D:φ74mm	D:φ74mm	D:φ74mm

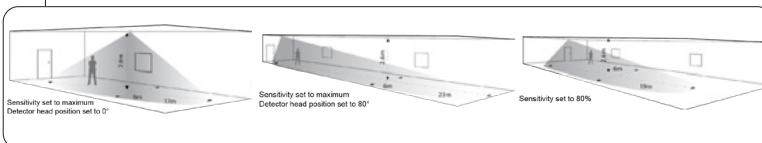

E&OE MAY OCCUR

COMPACT FLUSH MICROWAVE

SENSORS

OTHER - SENSORS - MWS6

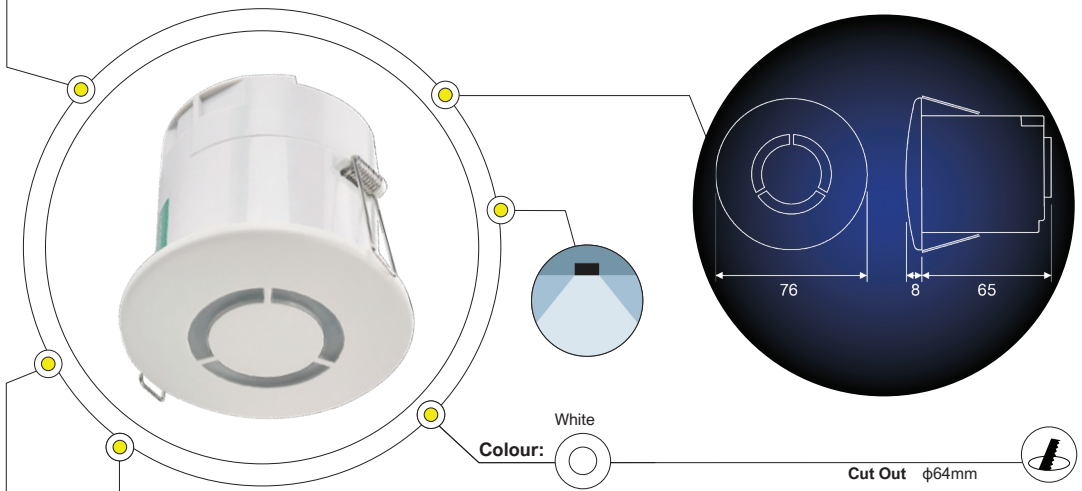

+ IP 40



5 YRS

PHYSICAL DATA

FEATURES

- Material: Flame retardant ABS and Polycarbonate/ABS
- The MWS6 is a mid-range microwave presence/absence detector for the automatic control of lighting, heating and ventilation
- This detector has a low profile design which allows flush mounting into a ceiling tile, or surface mounting using a detector back box. Its reduced head size makes it unobtrusive to occupants
- The simple plug in connections reduce installation time. The optional infrared remote handset allows the user to override the set up
- Functionality is fully programmable using either the UHS5 or

UNLCDHS handset

OPTIONS & ACCESSORIES

- Available control methods: PRM Switching, DALI / DSI Dimming, 1-10V Analogue Dimming and KNX
- Functionality is fully programmable using either the optional UHS5 or UNLCDHS handsets
- Available options: LV, VFC, 2CH, 2CH NC

MOUNTING: Recessed or Surface (with detector box)

APPLICATION AREAS: Indoor, Commercial, Residential, Retail, Hospitality

TECHNICAL DATA

MWS6-PRM

MWS6-DD

MWS6-AD

CONTROL METHOD	PRM SWITCHING	DALI / DSI DIMMING	1-10V ANALOGUE
DEVICE/BALLAST CONTROL	n/a	up to 20 DRIVERS/BALLASTS	up to 10 DRIVERS/BALLASTS
SUPPLY VOLTAGE AC	230VAC +/- 10%	230VAC +/- 10%	230VAC +/- 10%
MICROWAVE FREQUENCY (HZ)	5.8GHZ	5.8GHZ	5.8GHZ
SUPPLY frequency (HZ)	50HZ	50HZ	50HZ
POWER CONSUMPTION			
- PARASITIC MW	665mW	n/a	690mW
- TERMINAL CAPACITY	2.5mm ²	2.5mm ²	2.5mm ²
OPERATING TEMP °C	-10°C TO 50°C	-10°C TO 50°C	-10°C TO 50°C
HUMIDITY	5-95% non condensing	5-95% non condensing	5-95% non condensing
MAX LOADS			
- INCANDESCENT (INC)	10A	10A	10A
- FLUORESCENT (F)	10A	10A	10A
- COMPACT FLUORESCENT (CF)	10A	10A	10A
- LED Lighting	10A	10A	10A
- RESISTIVE HEATERS	10A	10A	10A
TIME-OUT RANGE	10s - 99m	10s - 99m	10s - 99m
WEIGHT (KG)	0.15KG	0.15KG	0.15KG
DIMENSIONS	D:φ76 x H:73mm	D:φ76 x H:73mm	D:φ76 x H:73mm
CUT OUT	D:φ64mm	D:φ64mm	D:φ64mm

Detection pattern

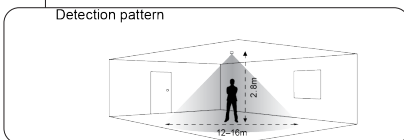

E&OE MAY OCCUR

> HANDSETS



OTHER - HANDSETS
Project Boschendaal Noord Art Gallery

COMPACT PROGRAMMING REMOTE

SENSOR HANDSETS

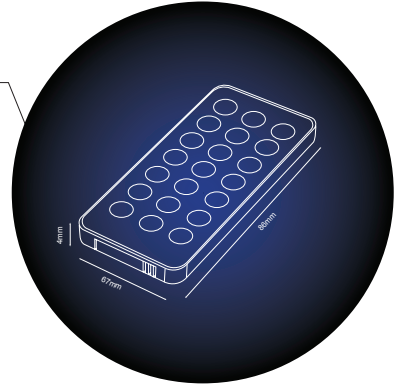

PHYSICAL DATA



FEATURES

- Material: Polycarbonate
- The UHS5 is a compact infrared handset used for programming of IR enabled CP products
- The UHS5 is now available to download as an app (Android™ 4.1 Jelly Bean and above)

MOUNTING:

Surface, Hand-held device

APPLICATION AREA:

Indoor, Commercial, Residential, Retail, Hospitality

TECHNICAL DATA

UHS5

CONTROL METHOD	INFRARED REMOTE
BATTERY	3VDC LITHIUM BATTERY CR2025
INFRARED RANGE	7m
OPERATING TEMP °C	0°C TO 35°C
HUMIDITY	5-95% non condensing
WEIGHT (KG)	0.017KG
DIMENSIONS	L:67 x W:4 x H:86mm



COMPACT PROGRAMMING REMOTE

SENSOR HANDSETS



Colour: 

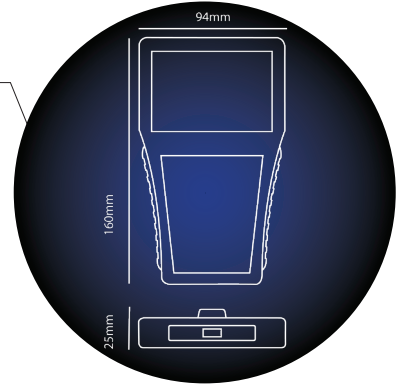

PHYSICAL DATA

FEATURES

- Material: Polycarbonate
- The UNLCDHS is a compact infrared handset with LCD display used for the operation, configuration, and programming of CP Electronics products that have the ability to be programmed via IR and/or RF
- These include PRM, DD and AD detectors and the RAPID, Vitesse Plus, and An-10 systems.
- Key features include USB port and being able to read

the settings from a device

MOUNTING:

Surface, Hand-held device

APPLICATION AREA:

Indoor, Commercial, Residential, Retail, Hospitality

TECHNICAL DATA

UNLCDHS

CONTROL METHOD	INFRARED REMOTE
BATTERY	6VDC 4 x AAA Batteries
INFRARED RANGE	
- LOW	8m
- MEDIUM	15m
- HIGH	25m
USB	Type A socket 125mb to 16GB FAT or FAT32
OPERATING TEMP °C	0°C TO 35°C
HUMIDITY	5-95% non condensing
WEIGHT (KG)	0.017KG
DIMENSIONS	L:94 x W:25 x H:160mm



E&OE MAY OCCUR



A large rectangular area with a light gray background, containing numerous horizontal dotted lines for writing.

NOTES



A large rectangular area with a light gray background, containing numerous horizontal dotted lines for writing.

NOTES





Lights By Linea
— Since (1990) —

For the love of *light*

Cape Town | 48 Marine Dr, Paarden Eiland | T: +27 21 511 6116
info@lightsbylinea.com | www.lightsbylinea.com

Wayne Roberts - Chairman | Registration No: 2000/001191/07 | Vat reg no: 4860191180
Lights By Linea (PTY) Ltd is a Level 2 BBBEE Contributor